



US00D591321S

(12) **United States Design Patent**
Sheppard et al.

(10) **Patent No.:** **US D591,321 S**
(45) **Date of Patent:** **** Apr. 28, 2009**

(54) **DIGITAL VIDEO CAMERA WITH BUILT-IN CONNECTOR**

Primary Examiner—Adir Aronovich
(74) *Attorney, Agent, or Firm*—Rutan & Tucker, LLP

(75) Inventors: **Nasahn Adam Sheppard**, Mill Valley, CA (US); **Maarten Dinger**, San Francisco, CA (US); **Allan Freas Velzy**, San Francisco, CA (US); **Peter Michaelian**, Tappan, NY (US); **Jaewon Samuel Kang**, Santa Clara, CA (US); **Lionel Jingles**, San Francisco, CA (US); **John Louis Warpakowski Furlan**, Belmont, CA (US); **Greg Allen Cummings**, San Francisco, CA (US)

(57) **CLAIM**

The ornamental design for a digital video camera with built-in connector, as shown and described.

(73) Assignee: **Pure Digital Technologies, Inc.**, San Francisco, CA (US)

DESCRIPTION

(**) Term: **14 Years**

FIG. 1 is a top, front perspective view of a digital video camera with built-in connector showing our new design;

(21) Appl. No.: **29/304,515**

FIG. 2 is a top, rear perspective view thereof;

(22) Filed: **Mar. 3, 2008**

FIG. 3 is a top, front perspective view of the digital video camera with built-in connector, the connector being in an extended position;

(51) **LOC (9) Cl.** **16-01**

(52) **U.S. Cl.** **D16/202**

(58) **Field of Classification Search** D16/200–204,
D16/208, 218; 348/373–376; 358/909.1;
396/535–541

FIG. 4 is a top, rear perspective view thereof;

FIG. 5 is a reduced front elevational view thereof, the connector being in a retracted position;

FIG. 6 is a rear elevational view thereof;

FIG. 7 is a left side elevational view thereof;

FIG. 8 is a right side elevational view thereof;

FIG. 9 is a right side elevational view thereof, the connector being in an extended position;

FIG. 10 is a top plan view thereof;

FIG. 11 is a bottom plan view thereof;

FIG. 12 is top plan view thereof, the connector being in an extended position;

FIG. 13 is a top, front perspective view thereof, the connector being in an extended position;

FIG. 13 is a top, front elevational view thereof, the connector being in an extended position;

FIG. 14 is a top, rear elevational view thereof, the connector being in an extended position; and,

FIG. 15 is a left side elevational view thereof, the connector being in an extended position.

See application file for complete search history.

(56) **References Cited**

U.S. PATENT DOCUMENTS

3,001,461 A *	9/1961	Irwin	396/176
D296,551 S *	7/1988	Mizogui	D16/202
D384,964 S *	10/1997	Ito et al.	D16/202
D401,257 S *	11/1998	Iino	D16/202
D464,664 S *	10/2002	Huang	D16/202
D467,259 S *	12/2002	Hung et al.	D16/218
D552,141 S *	10/2007	Kaplan et al.	D16/202

* cited by examiner

1 Claim, 13 Drawing Sheets

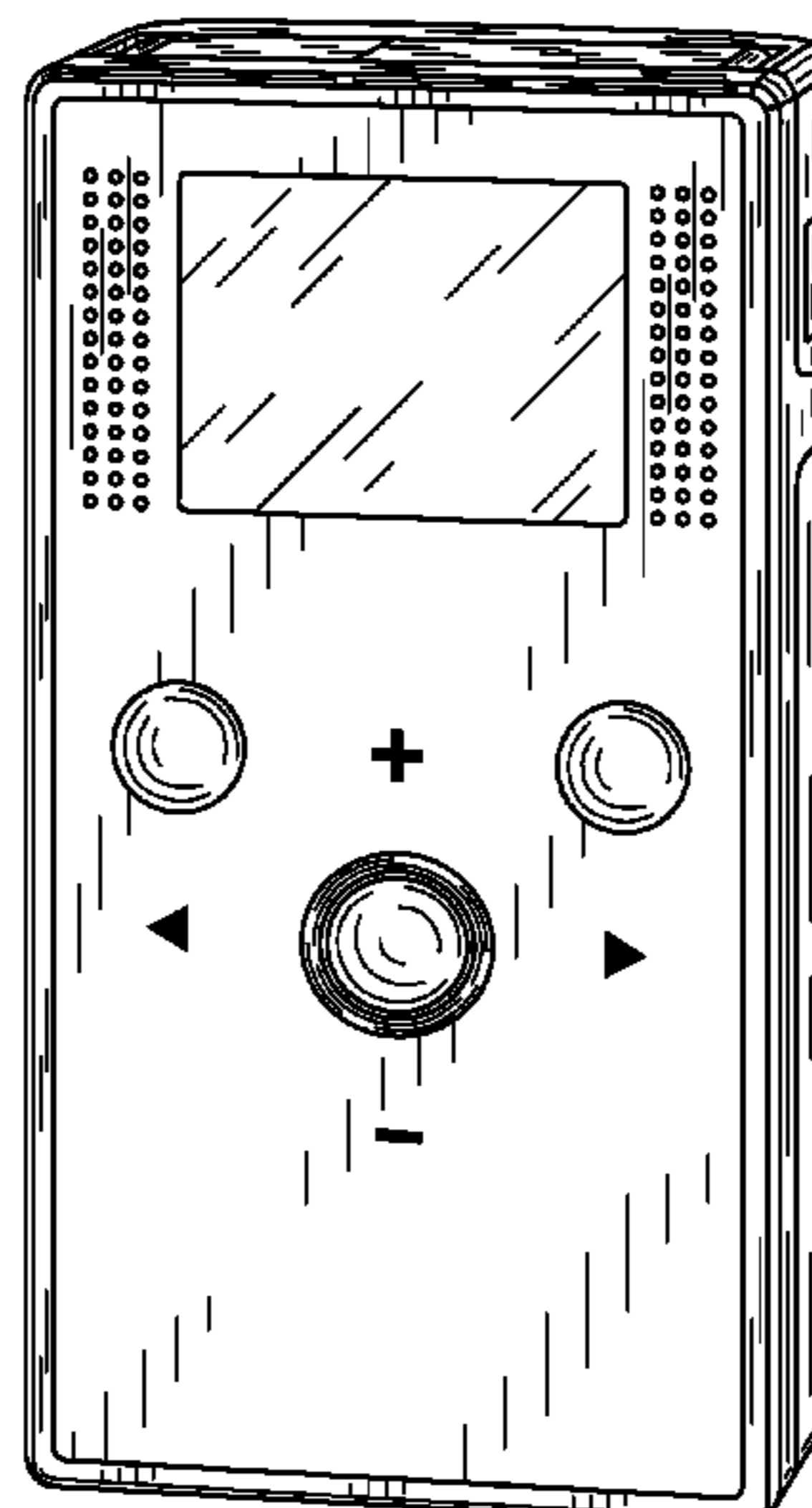
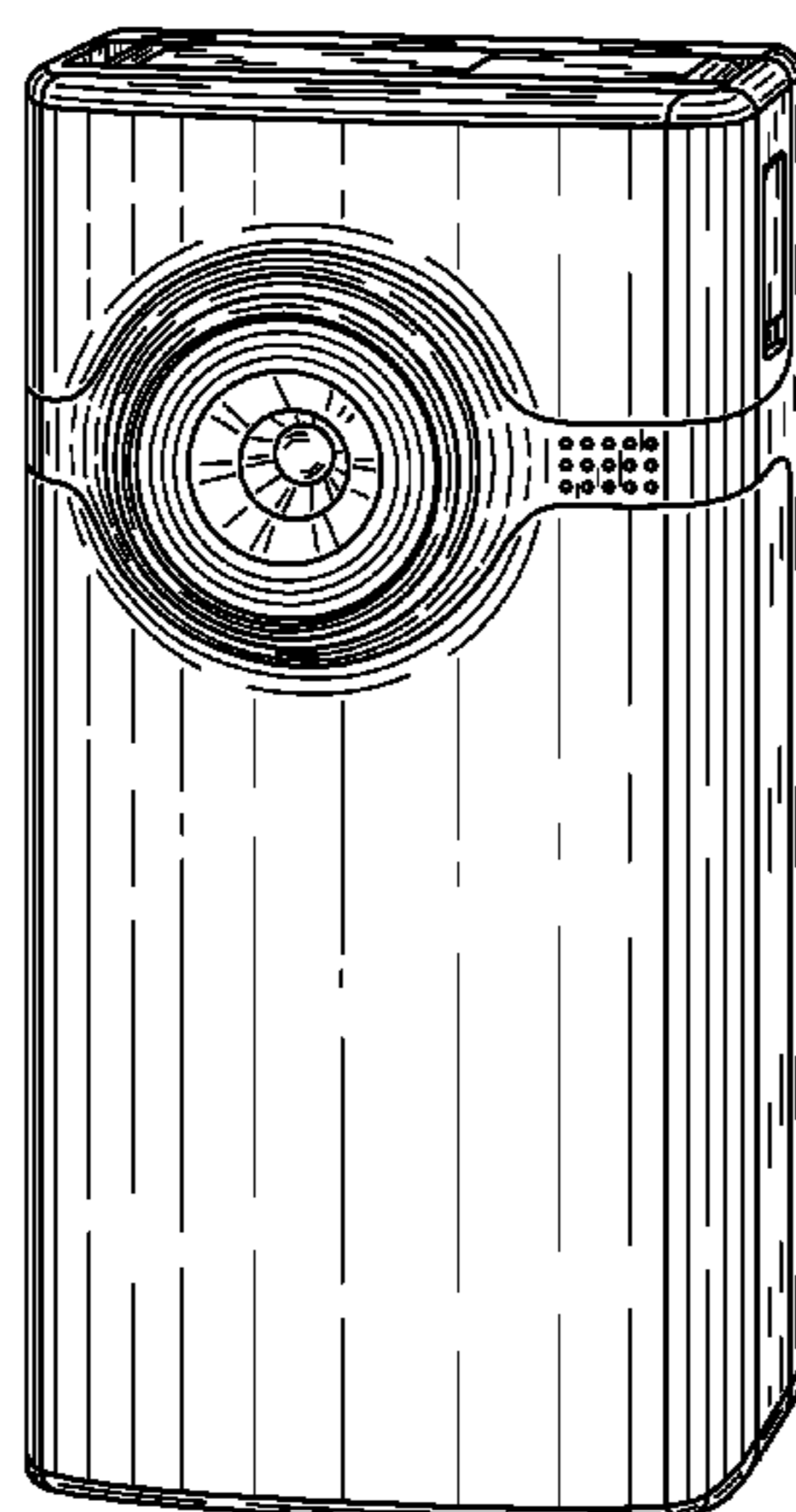

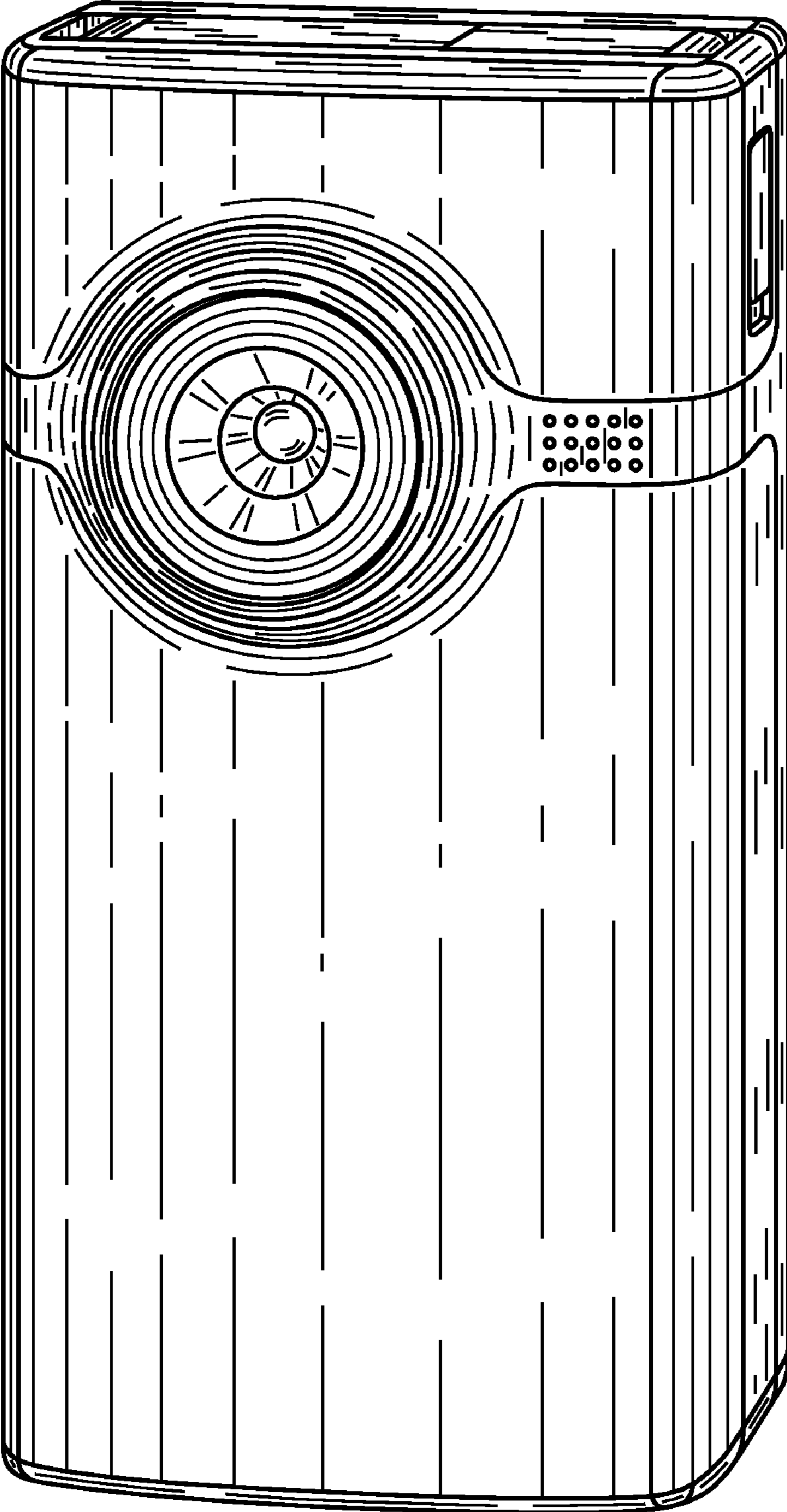

FIG. 1

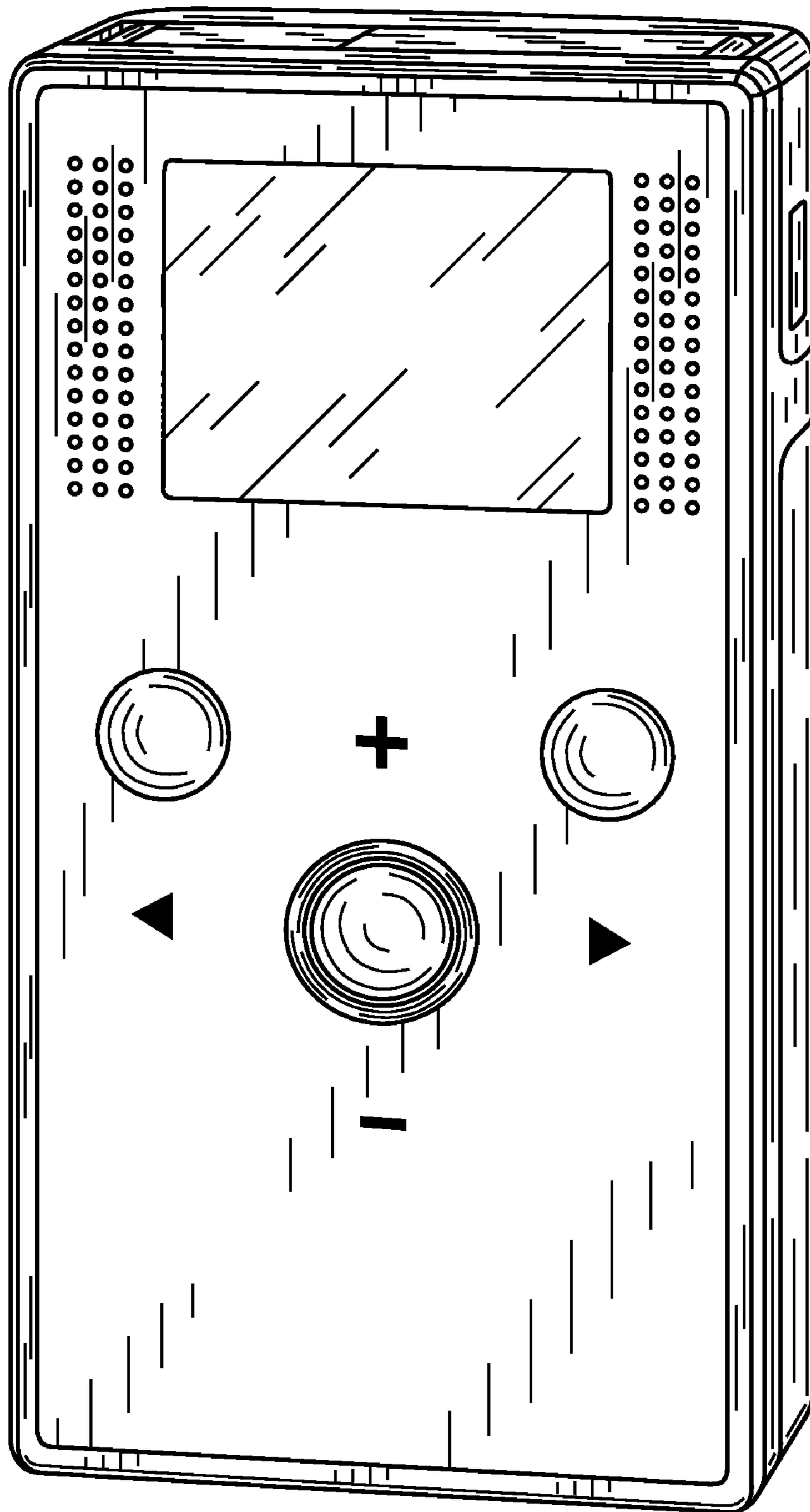

FIG. 2

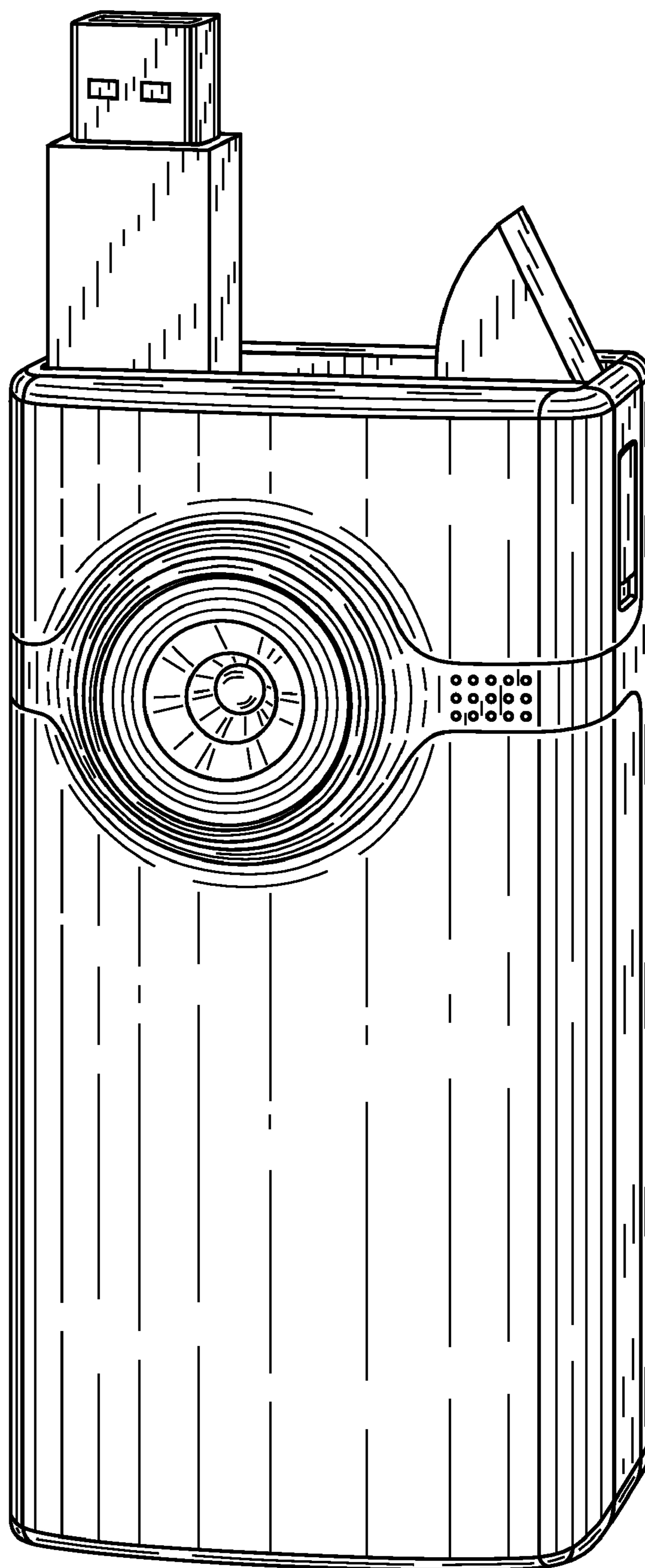

FIG. 3

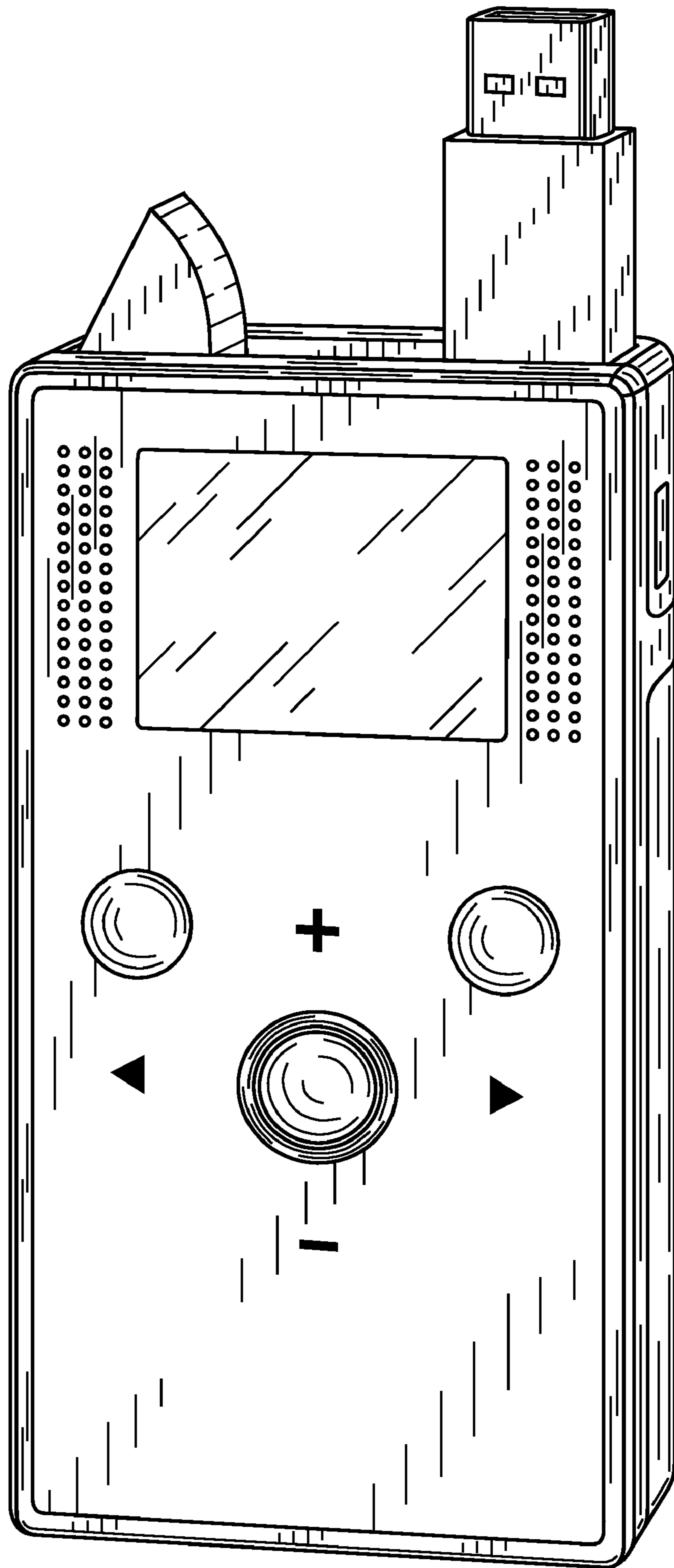

FIG. 4

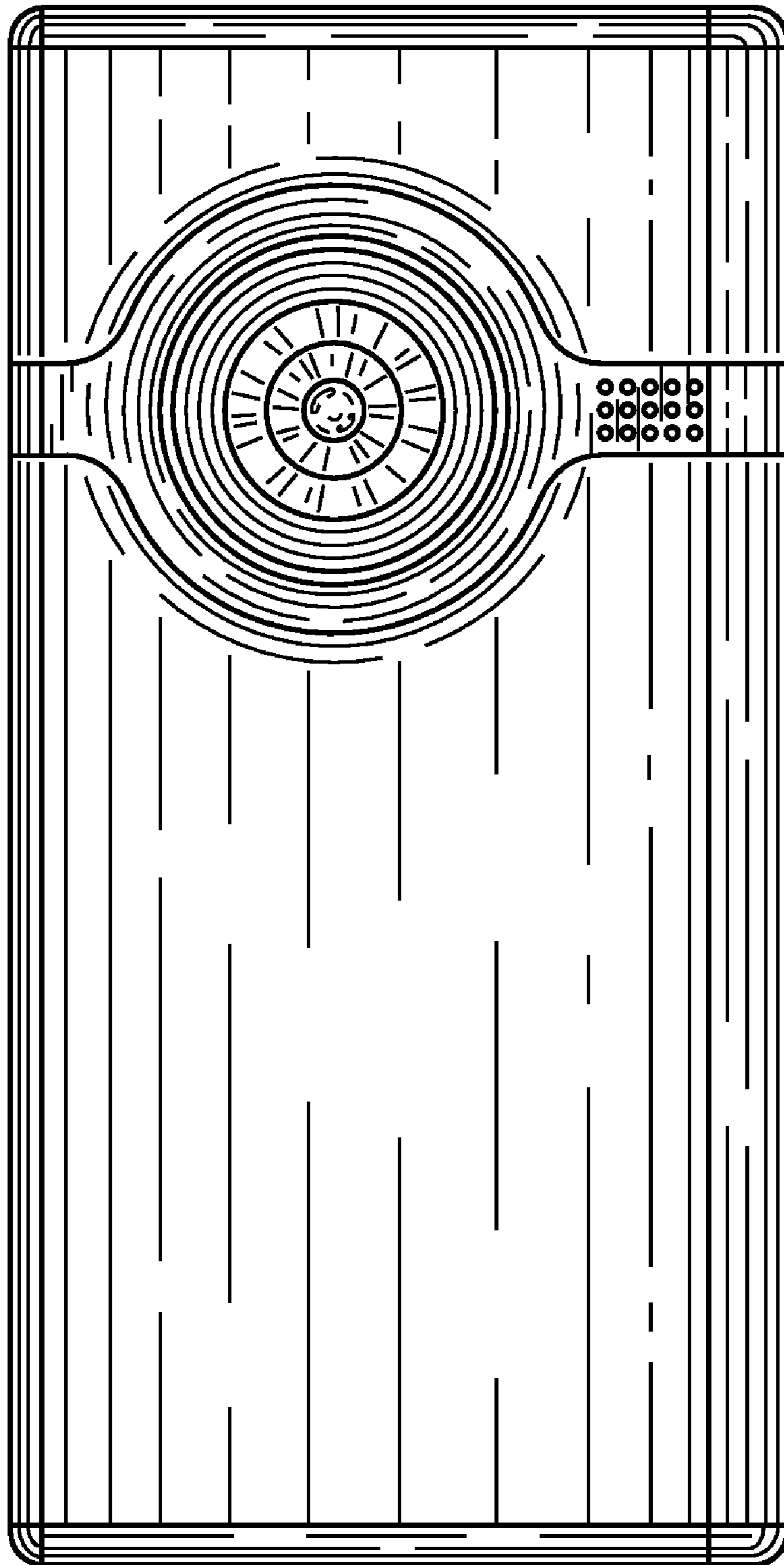

FIG. 5

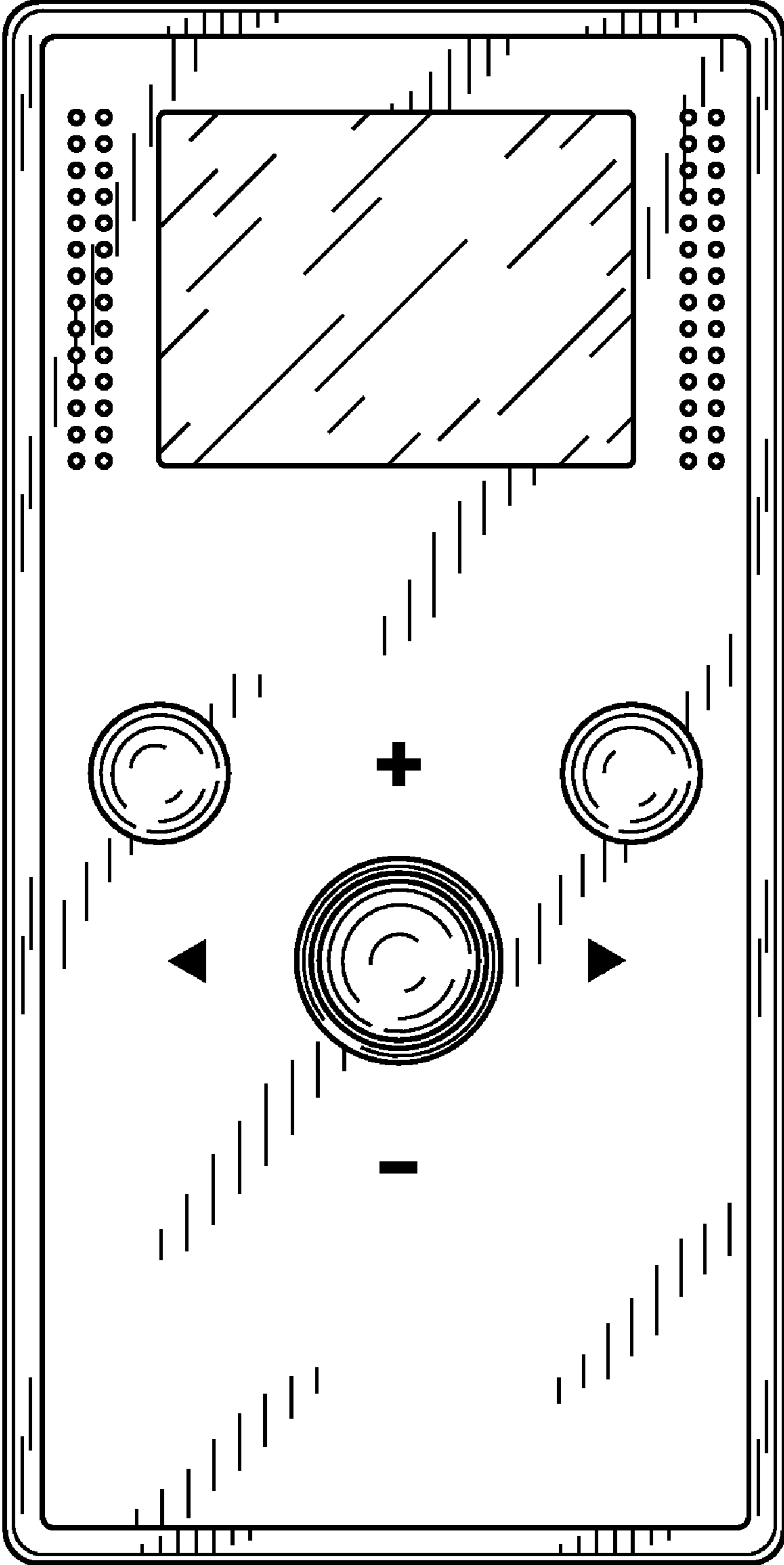

FIG. 6

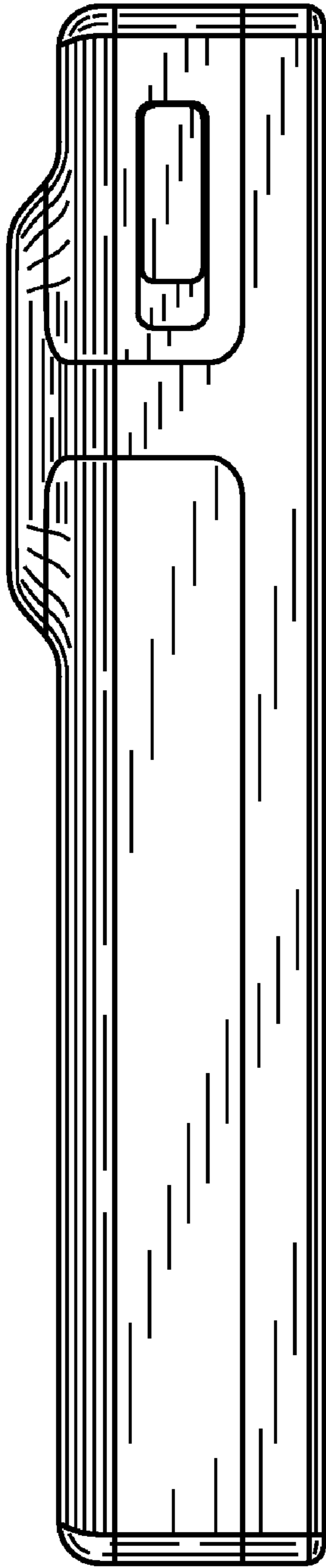

FIG. 7

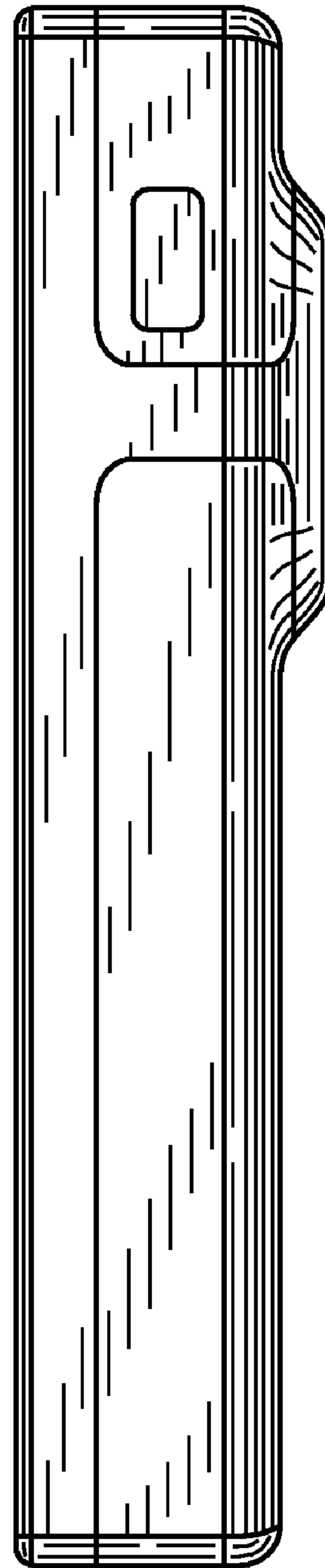

FIG. 8

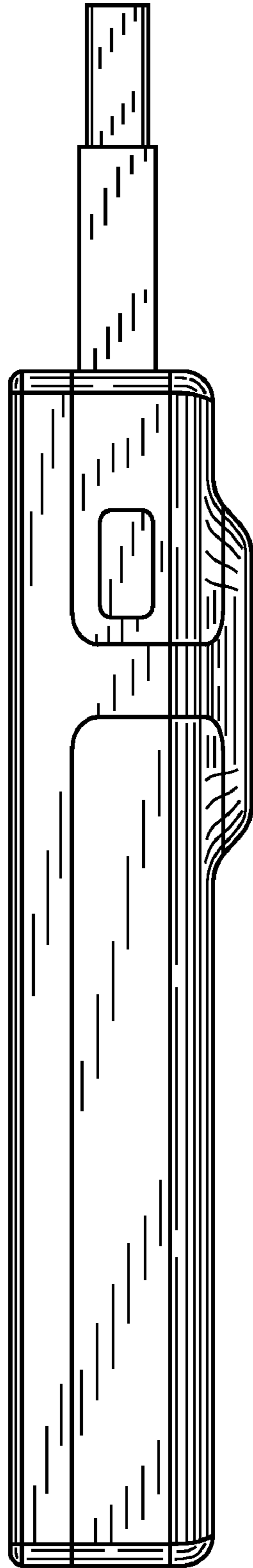

FIG. 9

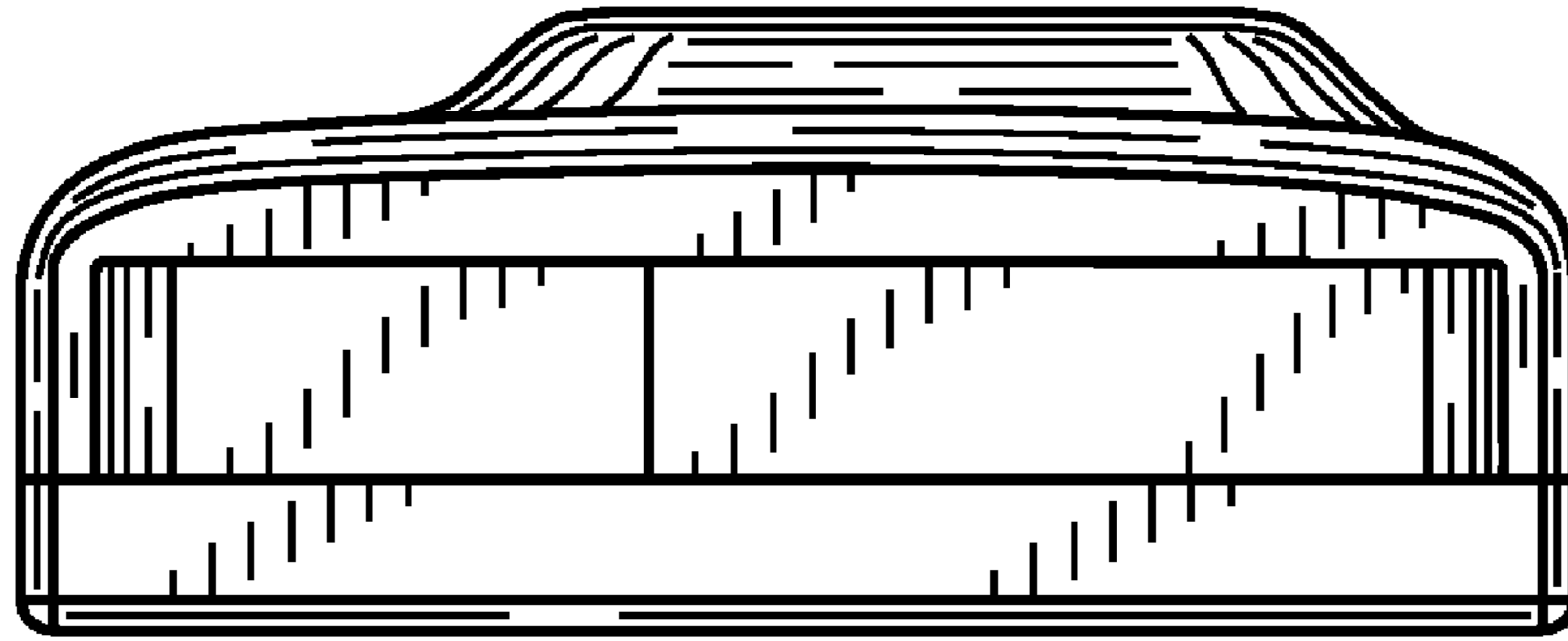

FIG. 10

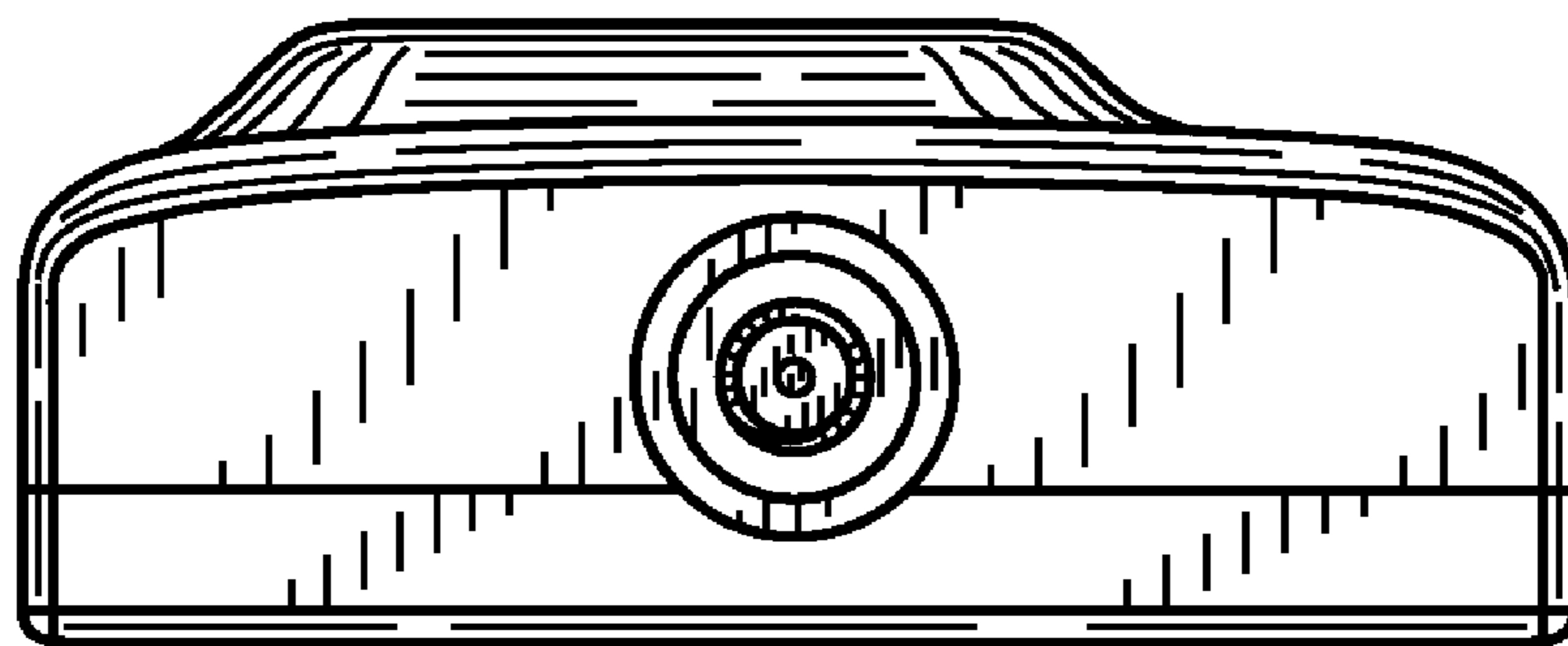

FIG. 11

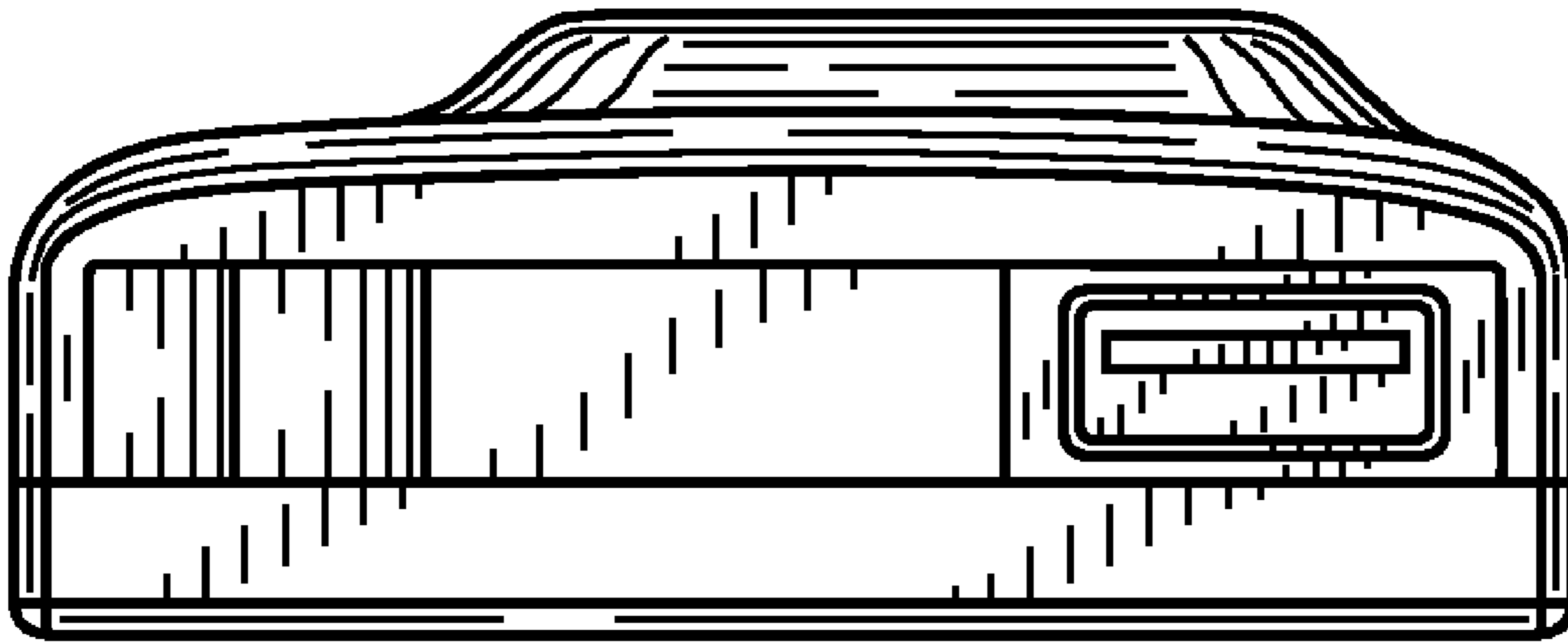

FIG. 12

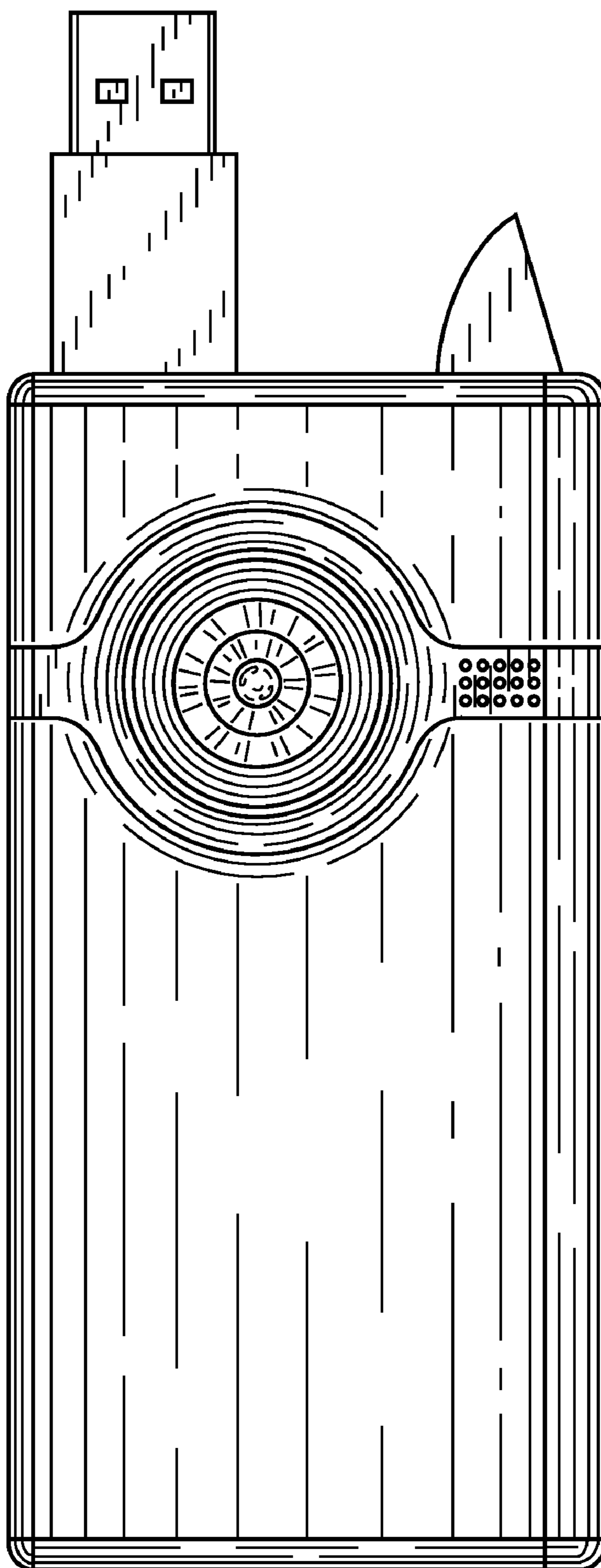

FIG. 13

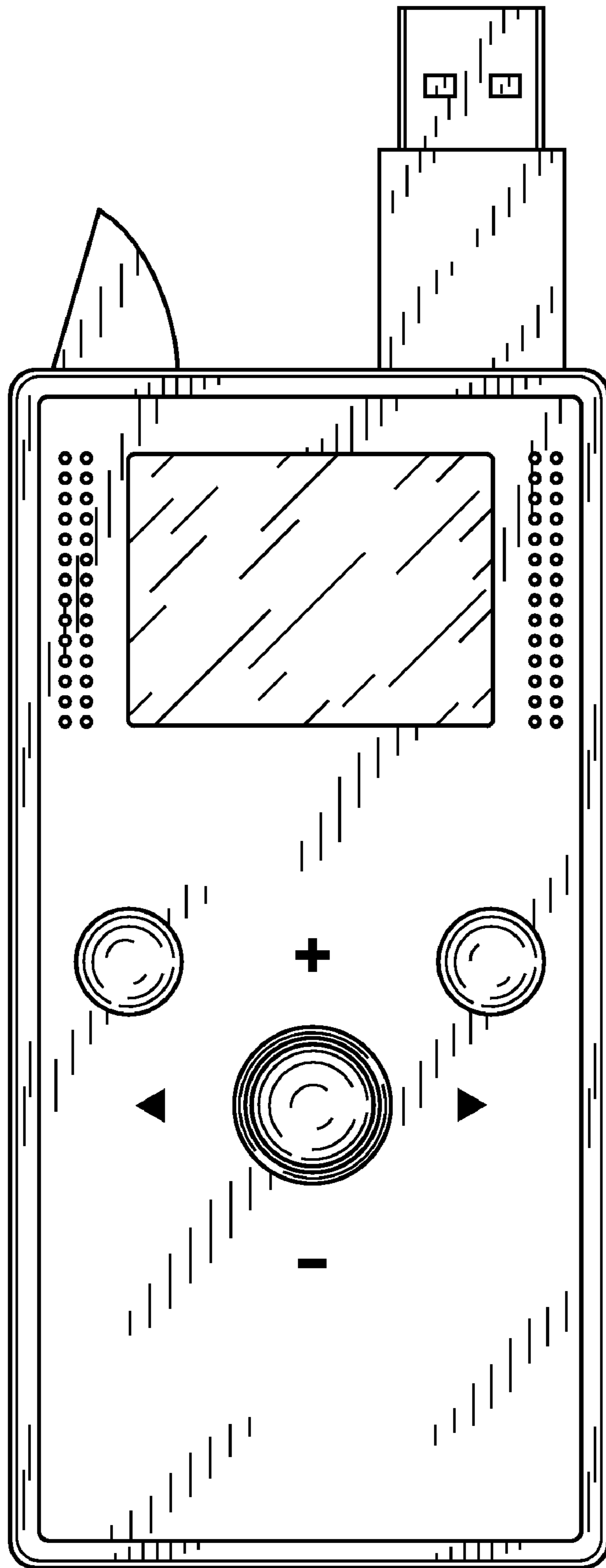

FIG. 14

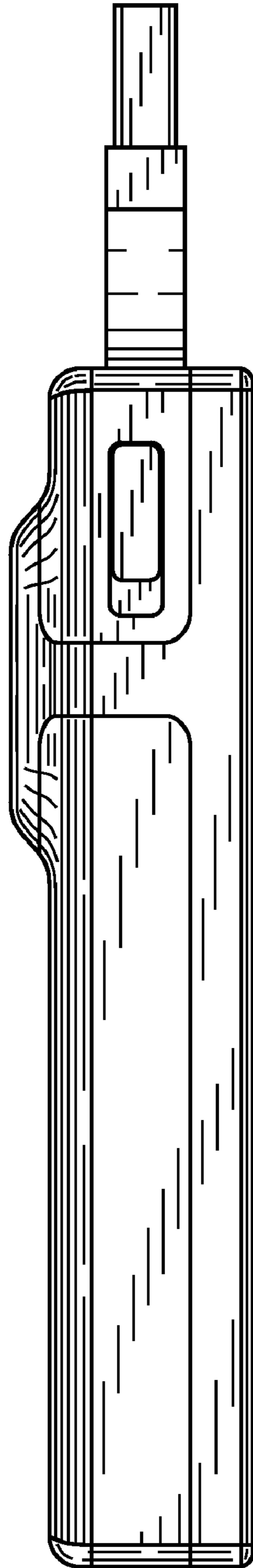

FIG. 15