



US00D591265S

(12) **United States Design Patent**
Fujiwara et al.

(10) **Patent No.:** **US D591,265 S**
(45) **Date of Patent:** **** Apr. 28, 2009**

(54) **SPEAKER**

(75) Inventors: **Satoru Fujiwara, Yao (JP); Masahide Suzuki, Yao (JP); Shouhei Takagaki, Yao (JP)**

(73) Assignee: **Hosiden Corporation, Osaka (JP)**

(**) Term: **14 Years**

(21) Appl. No.: **29/317,917**

(22) Filed: **May 9, 2008**

Related U.S. Application Data

(62) Division of application No. 29/279,071, filed on Apr. 19, 2007, now Pat. No. Des. 575,270.

(30) **Foreign Application Priority Data**

Nov. 7, 2006 (JP) 2006-30298
Nov. 7, 2006 (JP) 2006-30299

(51) **LOC (9) Cl.** **14-01**

(52) **U.S. Cl.** **D14/214; D14/215**

(58) **Field of Classification Search** D14/204,
D14/207, 210-216, 172; 181/143-144, 147-148,
181/150-153, 157, 198-199; 381/300-303,
381/306, 332-333, 336, 345, 361-364, 386-388
See application file for complete search history.

(56) **References Cited**

U.S. PATENT DOCUMENTS

D272,343 S 1/1984 Matsubara

D402,657 S * 12/1998 Renk D14/214
D485,825 S 1/2004 Yoneda
D511,766 S 11/2005 Suzuki
D519,986 S * 5/2006 Kamimura et al. D14/214
D533,163 S * 12/2006 Takase et al. D14/215
D535,977 S 1/2007 Suzuki

* cited by examiner

Primary Examiner—Nanda Bondade

(74) *Attorney, Agent, or Firm*—Panitch Schwarze Belisario & Nadel LLP

(57) **CLAIM**

The ornamental design for a speaker, as shown and described.

DESCRIPTION

FIG. 1 is a front, right and top perspective view of a speaker in accordance with our new design;

FIG. 2 is a rear, left and top perspective view thereof;

FIG. 3 is a front elevation view thereof;

FIG. 4 is a rear elevation view thereof;

FIG. 5 is a left side elevation view thereof;

FIG. 6 is a right side elevation view thereof;

FIG. 7 is a top plan view thereof; and,

FIG. 8 is a bottom plan view thereof.

1 Claim, 3 Drawing Sheets

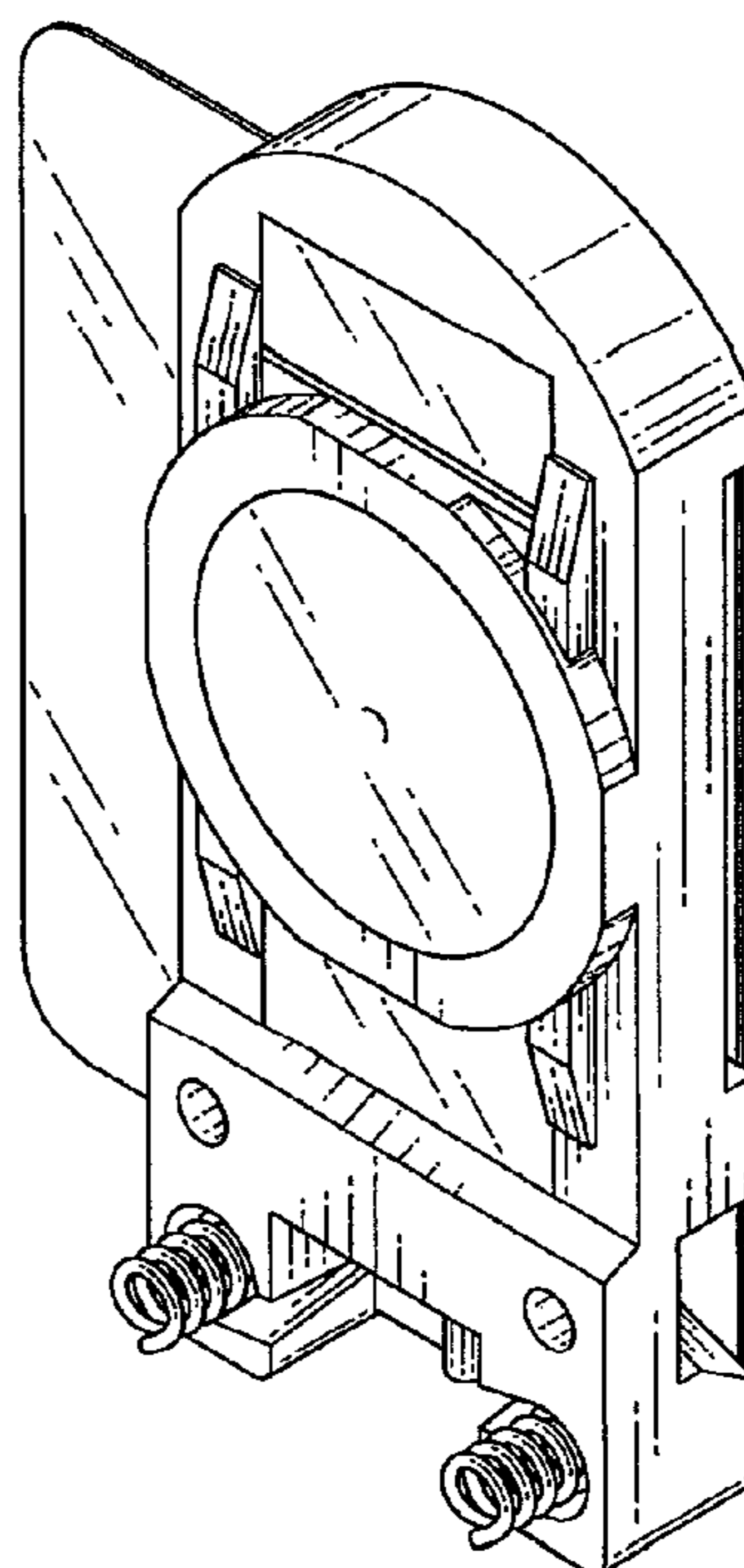
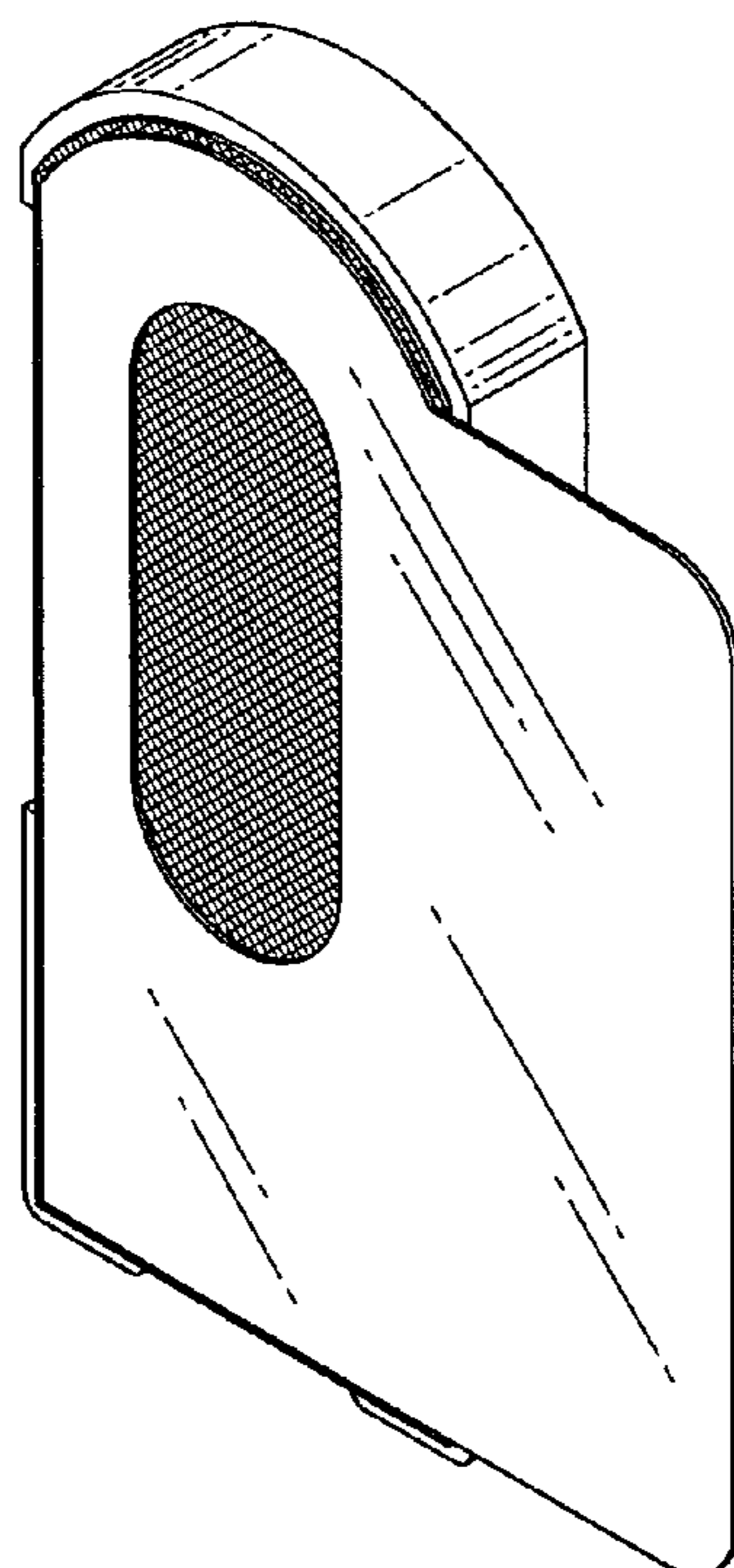

Fig. 1

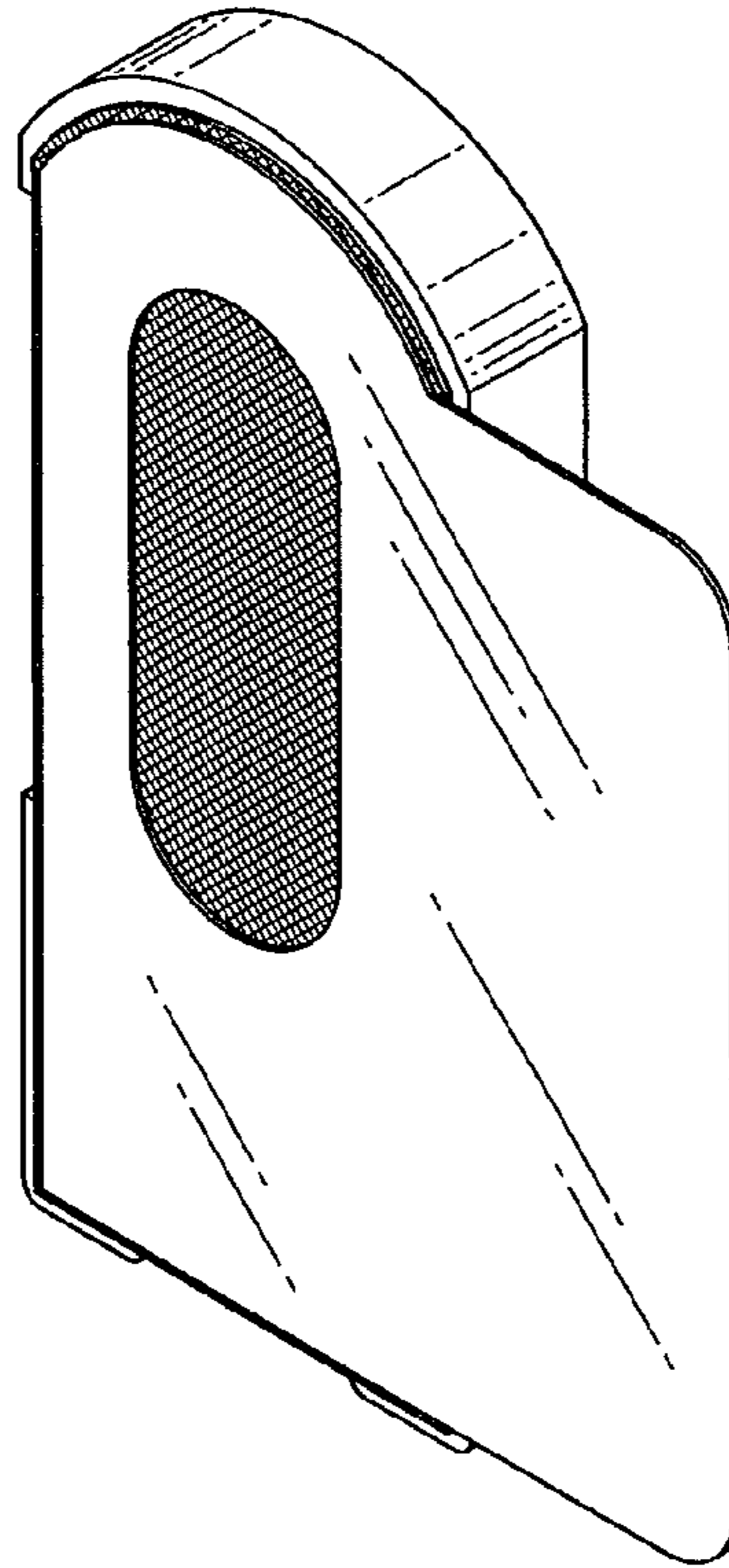

Fig. 2

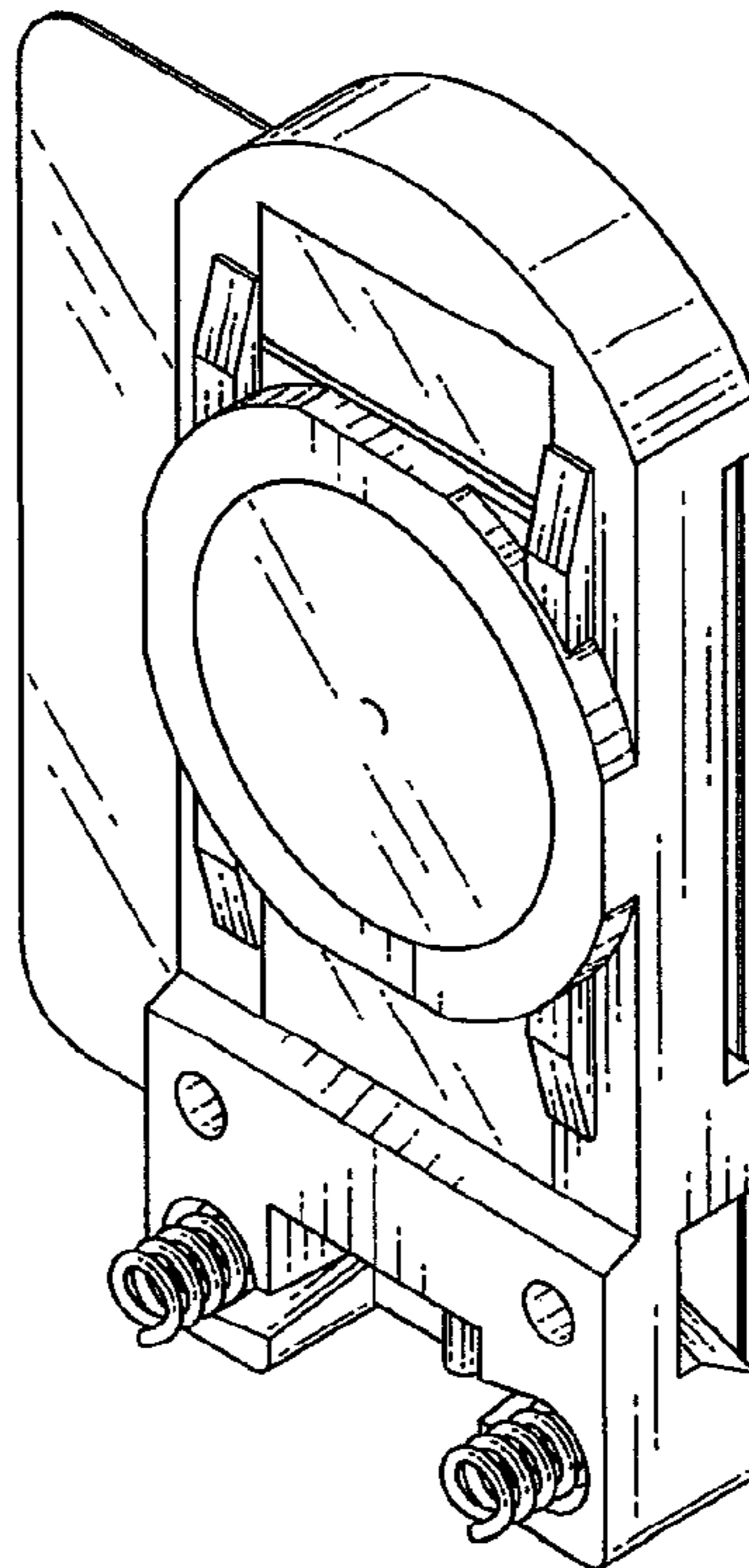

Fig. 3

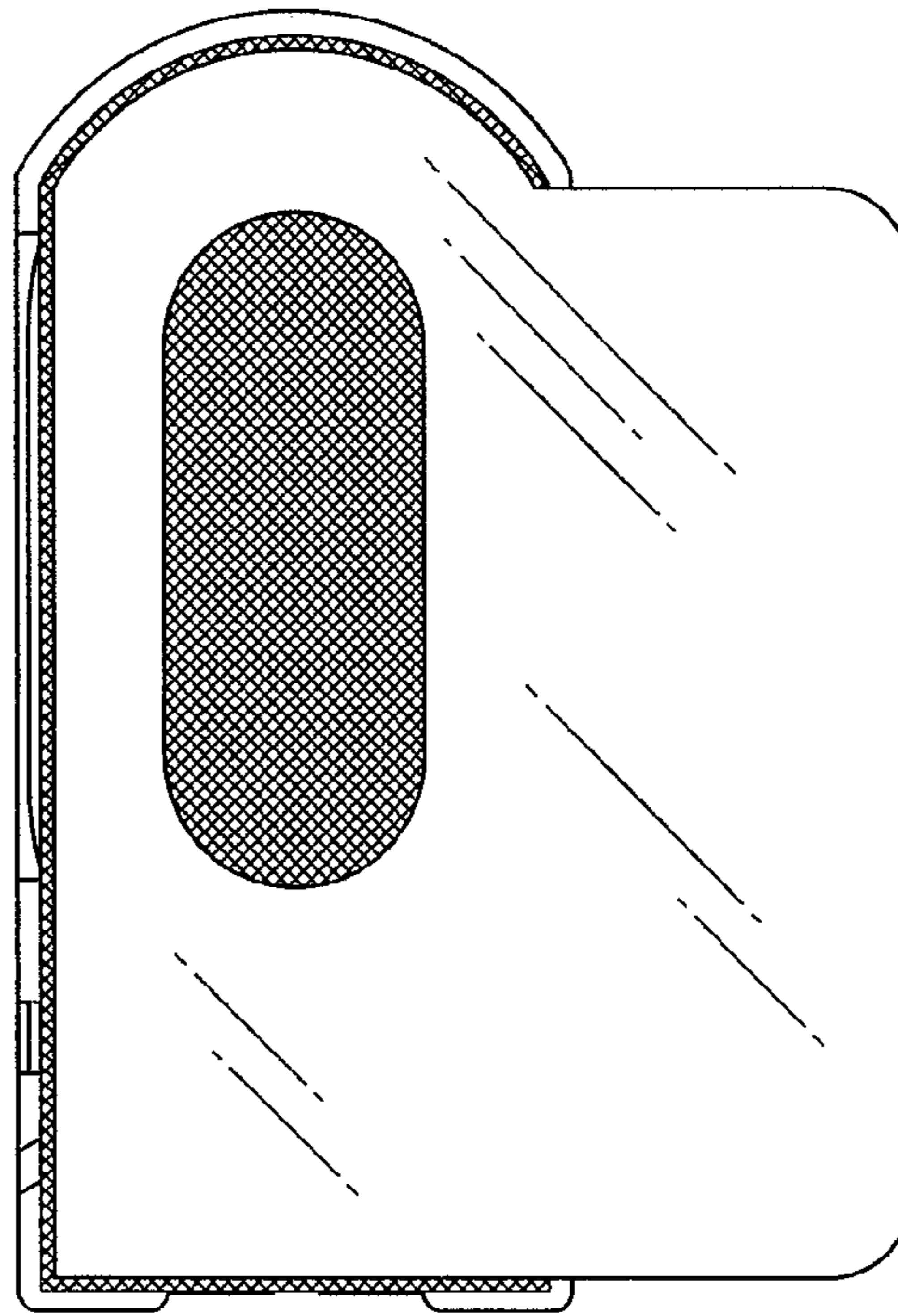

Fig. 4

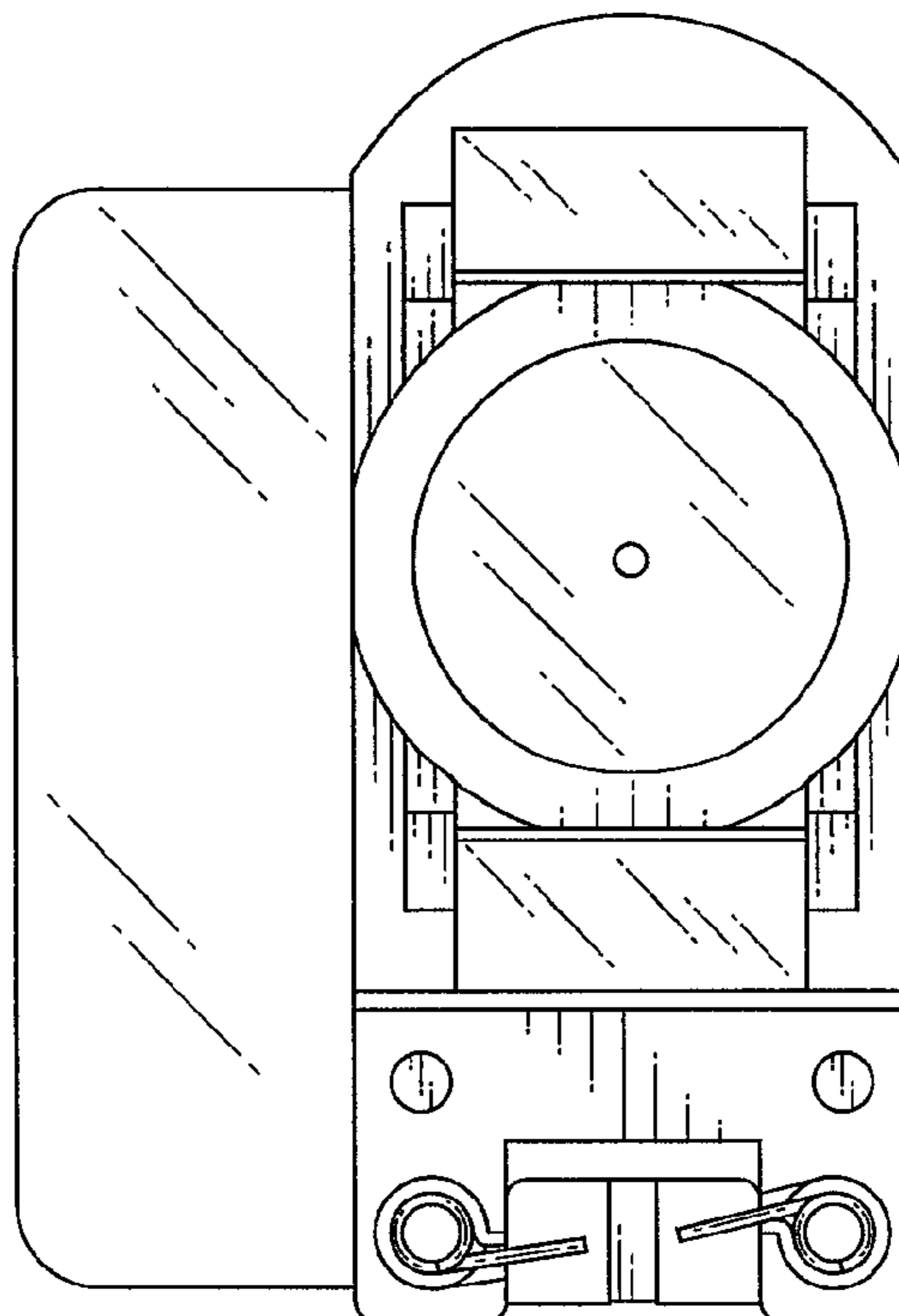

Fig. 5

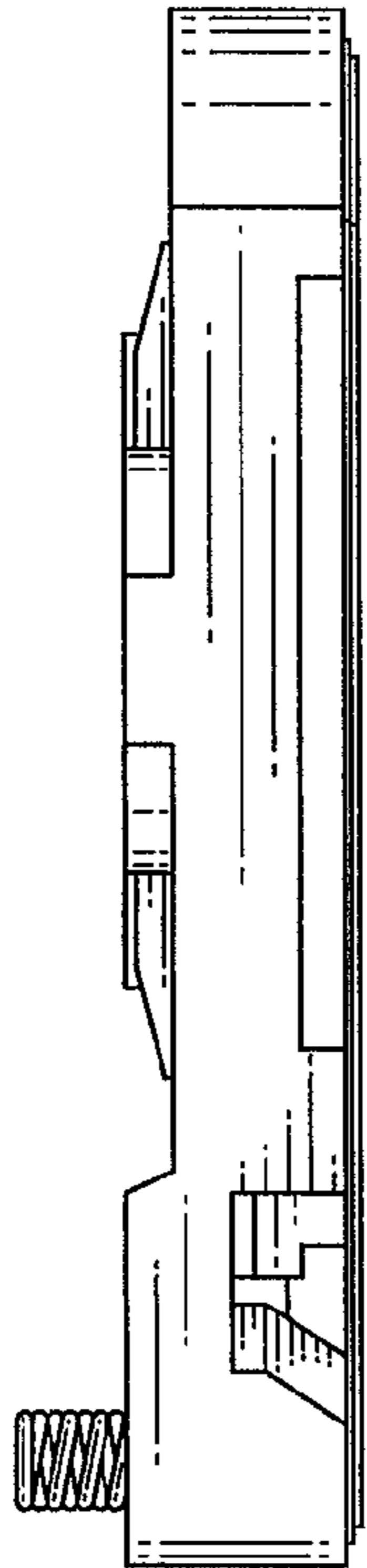

Fig. 6

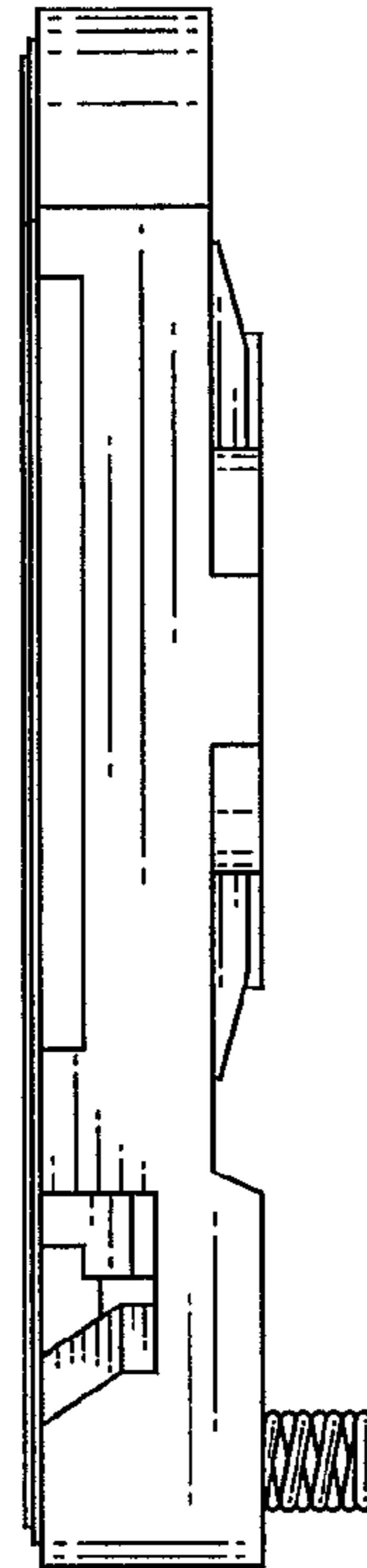

Fig. 7

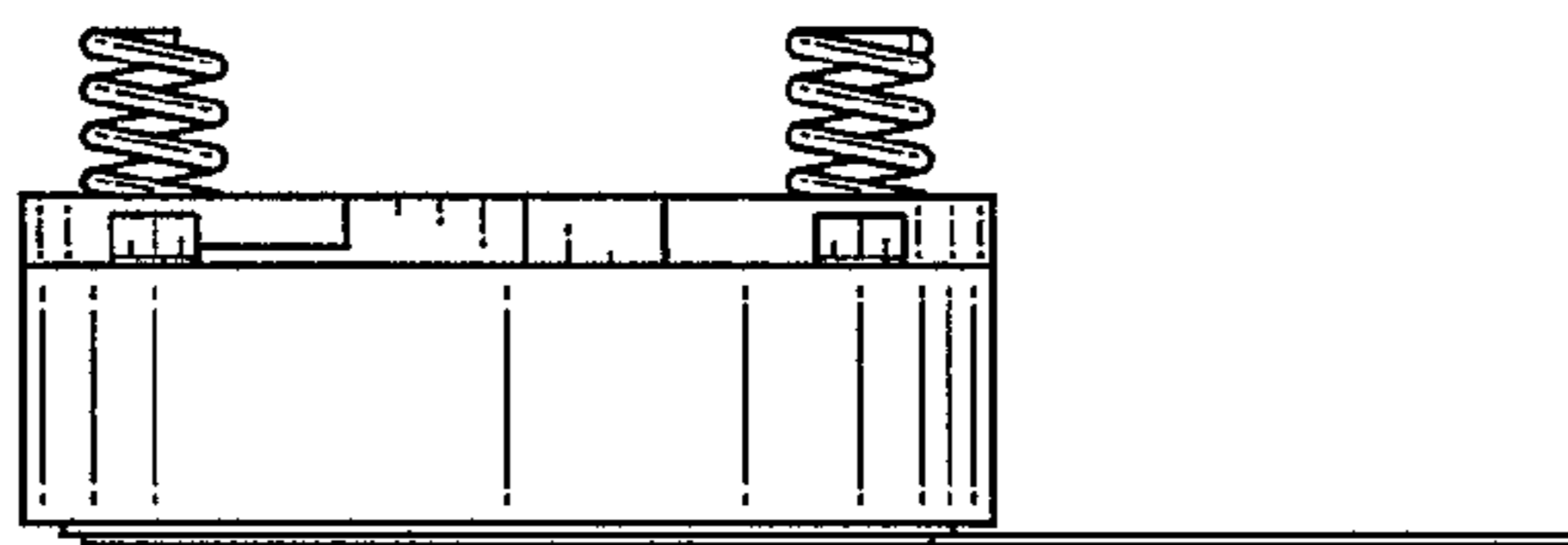

Fig. 8

