



US00D591259S

(12) **United States Design Patent**
Choi et al.

(10) **Patent No.:** **US D591,259 S**
(45) **Date of Patent:** **** Apr. 28, 2009**

(54) **CELLULAR PHONE**

(75) Inventors: **Jung-Hyun Choi**, Seoul (KR);
Sang-Min Hyun, Seoul (KR);
Chang-Hwan Hwang, Goyang-si (KR)

(73) Assignee: **Samsung Electronics Co., Ltd.**,
Suwon-Si (KR)

(**) Term: **14 Years**

(21) Appl. No.: **29/321,985**

(22) Filed: **Jul. 28, 2008**

(51) **LOC (9) Cl.** **14-03**

(52) **U.S. Cl.** **D14/138 AB**

(58) **Field of Classification Search** D14/138 AB,
D14/496, 203.1–203.7, 341–347; 455/575.3
See application file for complete search history.

(56) **References Cited**

U.S. PATENT DOCUMENTS

D338,199	S *	8/1993	Andrew	D14/147
5,276,916	A *	1/1994	Pawlish et al.	455/575.1
D381,021	S *	7/1997	Williams et al.	D14/138 G
5,732,331	A *	3/1998	Harms	455/575.3
D407,718	S *	4/1999	Lee	D14/138 R
6,297,945	B1 *	10/2001	Yamamoto	361/681
6,751,487	B1 *	6/2004	Rydbeck et al.	455/575.3
D517,042	S *	3/2006	Byun et al.	D14/191
D550,191	S *	9/2007	Cho et al.	D14/138 AD
D551,649	S *	9/2007	Moon et al.	D14/138 AA
D554,149	S *	10/2007	Kim	D14/496
D556,177	S *	11/2007	Kim et al.	D14/138 AC
D561,155	S *	2/2008	Kim et al.	D14/138 AD
D561,728	S *	2/2008	Kim et al.	D14/138 AB
D561,729	S *	2/2008	Kim et al.	D14/138 AA
D565,598	S *	4/2008	Park	D14/496
D567,206	S *	4/2008	Daley et al.	D14/138 AD
D572,229	S *	7/2008	Kim et al.	D14/138 AD
D574,015	S *	7/2008	Masui	D14/496
D576,989	S *	9/2008	Lee et al.	D14/138 AD
D577,351	S *	9/2008	Kim et al.	D14/138 AA
D578,099	S *	10/2008	Park et al.	D14/138 AD
D579,896	S *	11/2008	Kim et al.	D14/138 R

D579,897	S *	11/2008	Kim et al.	D14/138 R
2005/0277439	A1 *	12/2005	Brelo et al.	455/556.2
2008/0207283	A1 *	8/2008	Zaitso et al.	455/575.3

OTHER PUBLICATIONS

Samsung F110 telephone, announced Mar. 2008, [online], [site visited Jan. 19, 2009]. Available from Internet ,<URL: http://www.gsmarena.com>.*

Samsung F500 telephone, announced Dec. 2006, [online], [site visited Jan. 19, 2009]. Available from Internet ,<URL: http://www.gsmarena.com>.*

Samsung M100 telephone, announced 2000, [online], [site visited Jan. 19, 2009]. Available from Internet ,<URL: http://www.gsmarena.com>.*

Sony Ericsson W350 telephone, announced Aug. 2008, [online], [site visited Jan. 19, 2009]. Available from Internet ,<URL: http://www.gsmarena.com>.*

LG KM380 telephone, announced Jun. 2008, [online], [site visited Jan. 19, 2009]. Available from Internet ,<URL: http://www.gsmarena.com>.*

(Continued)

Primary Examiner—Jeffrey D Asch

(74) *Attorney, Agent, or Firm*—Staas & Halsey LLP

(57) **CLAIM**

The ornamental design for a cellular phone, as shown and described.

DESCRIPTION

FIG. 1 is a perspective view of a cellular phone according to our new design;

FIG. 2 is a front elevational view thereof;

FIG. 3 is a rear elevational view thereof;

FIG. 4 is a left side elevational view thereof;

FIG. 5 is a right side elevational view thereof;

FIG. 6 is a top plan view thereof;

FIG. 7 is a bottom plan view thereof; and,

FIG. 8 is a perspective view of the cellular phone according to our new design in a state in which the cellular phone is open when used.

1 Claim, 8 Drawing Sheets

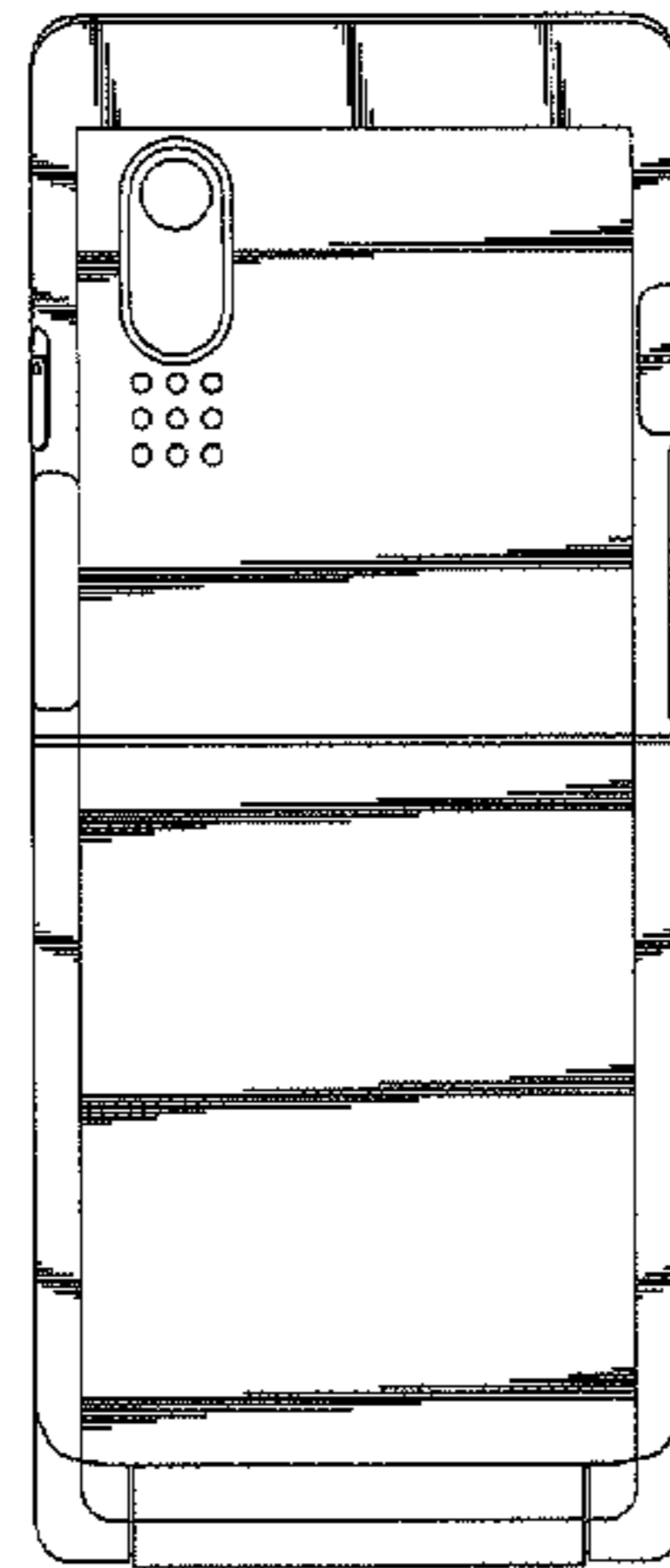
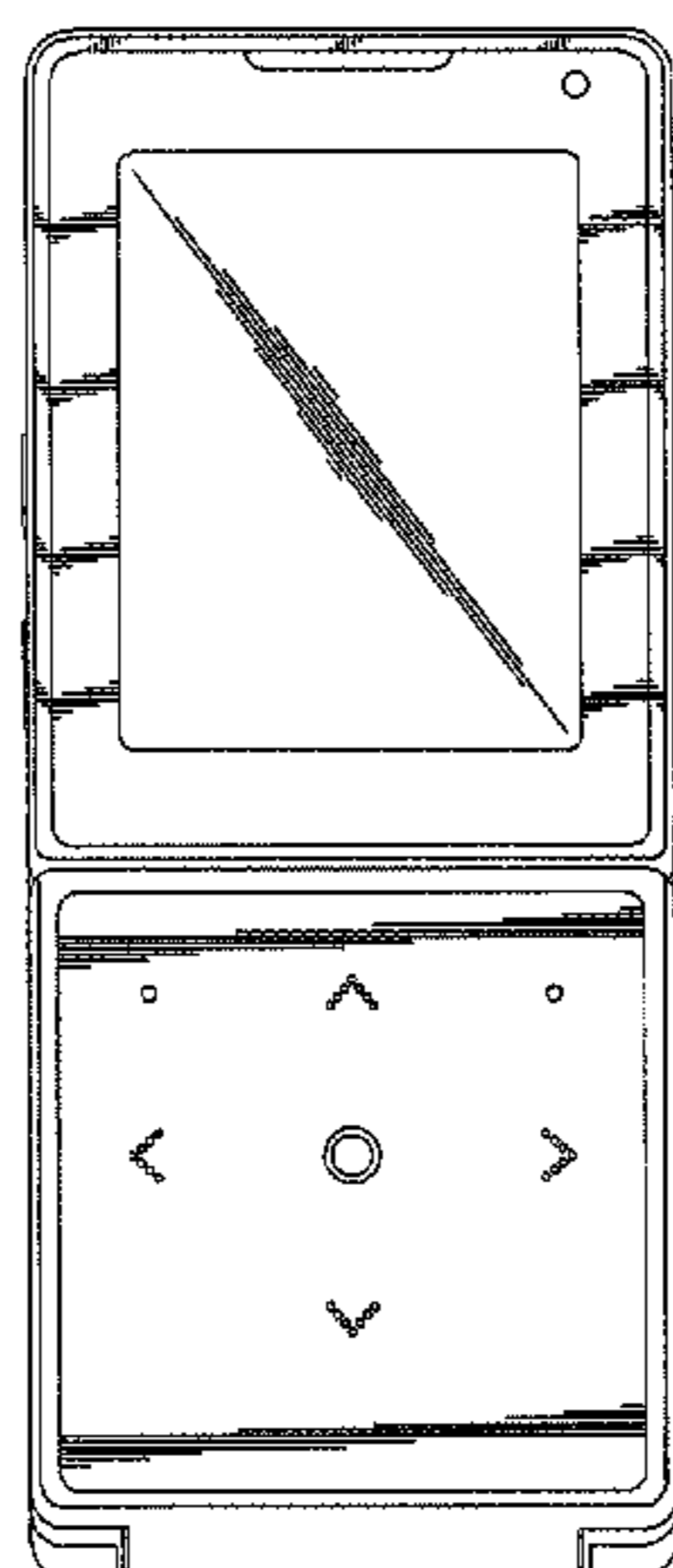

OTHER PUBLICATIONS

LG KM338 telephone, announced Feb. 2008, [online], [site visited Jan. 19, 2009]. Available from Internet ,<URL: <http://www.gsmarena.com>>.*

BenQ-Siemens EF51 telephone, announced Feb. 2006, [online], [site visited Jan. 19, 2009]. Available from Internet ,<URL: <http://www.gsmarena.com>>.*

* cited by examiner

FIG. 1

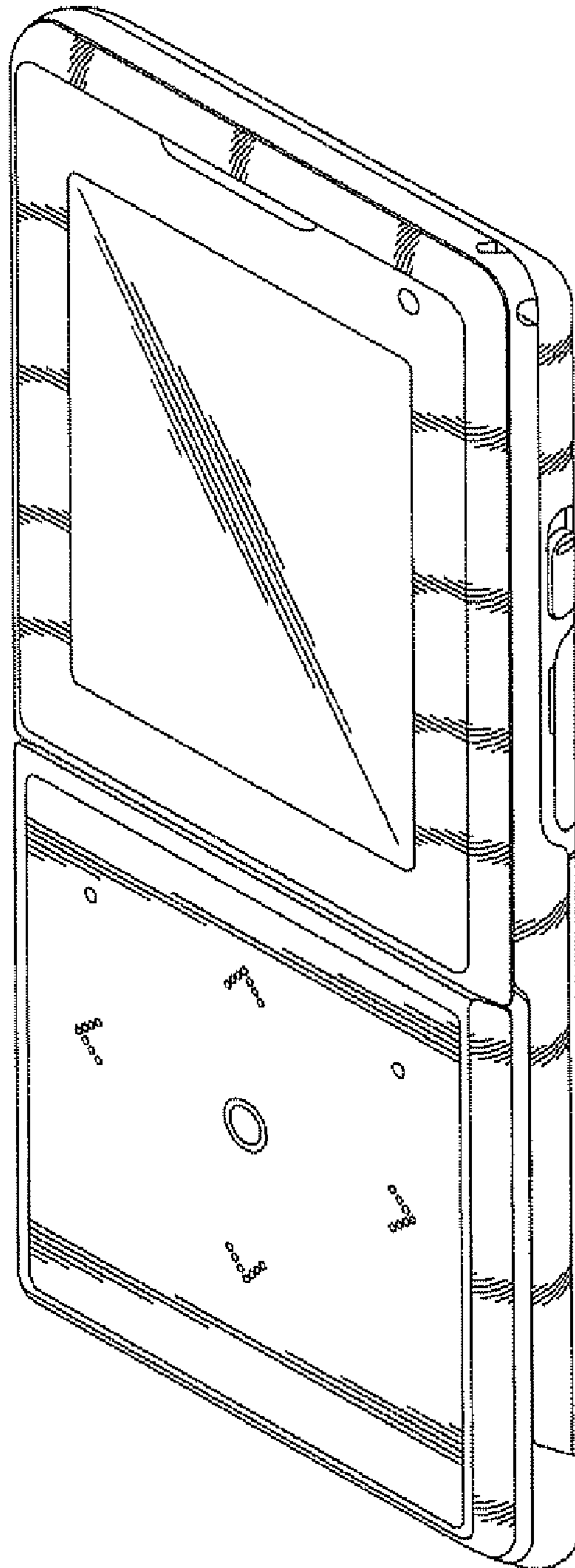

FIG. 2

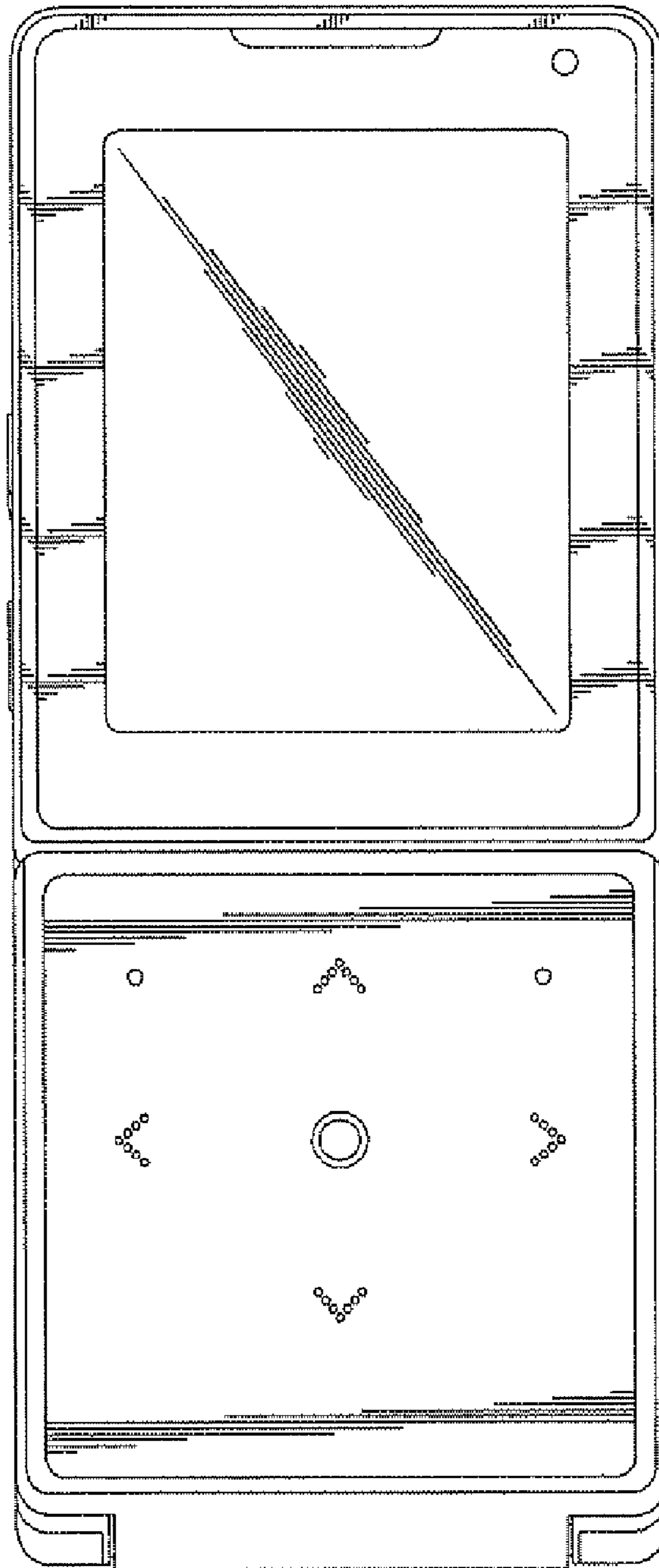

FIG. 3

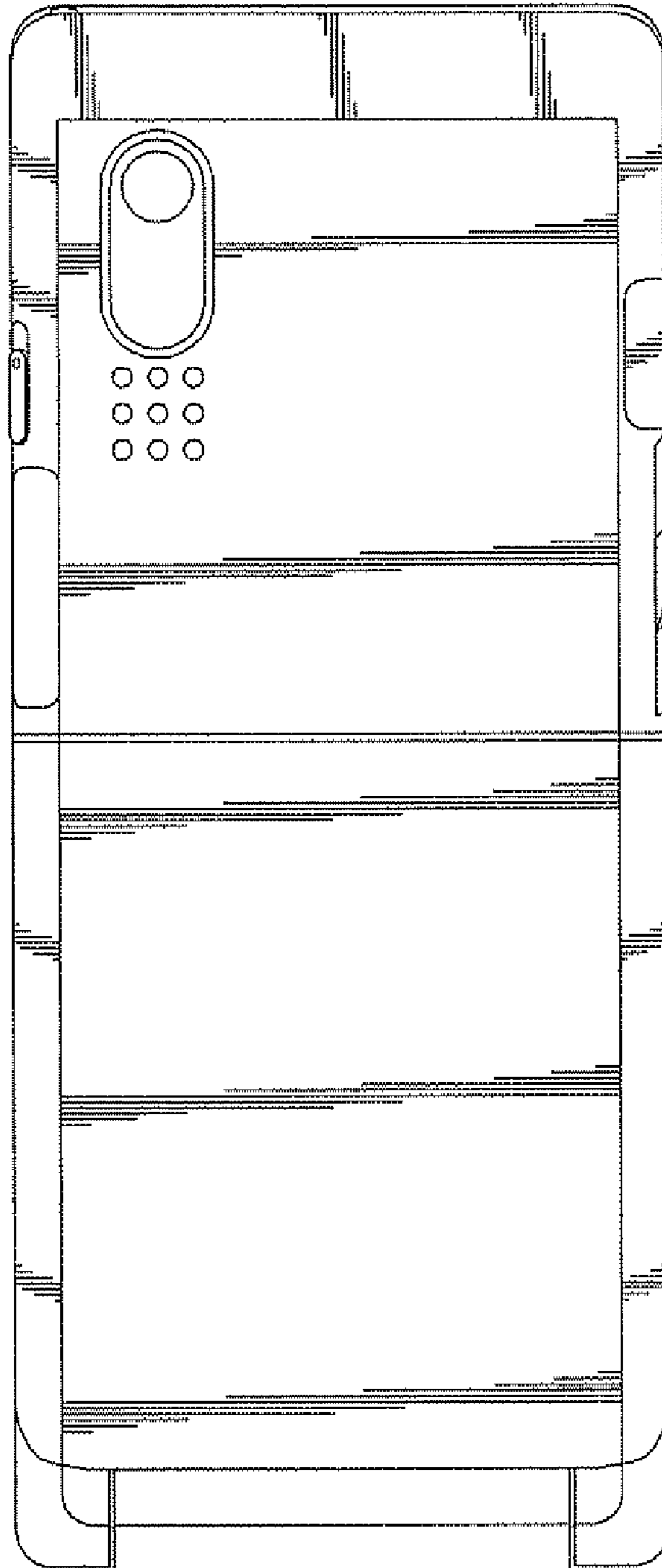

FIG. 4

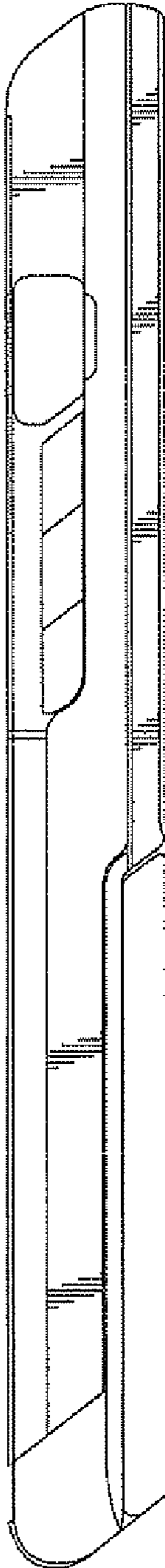

FIG. 5

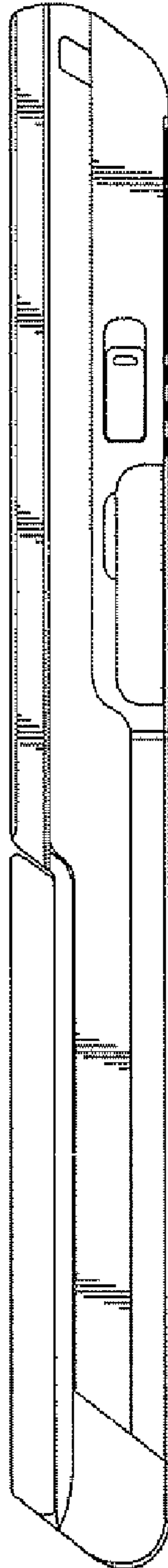

FIG. 6

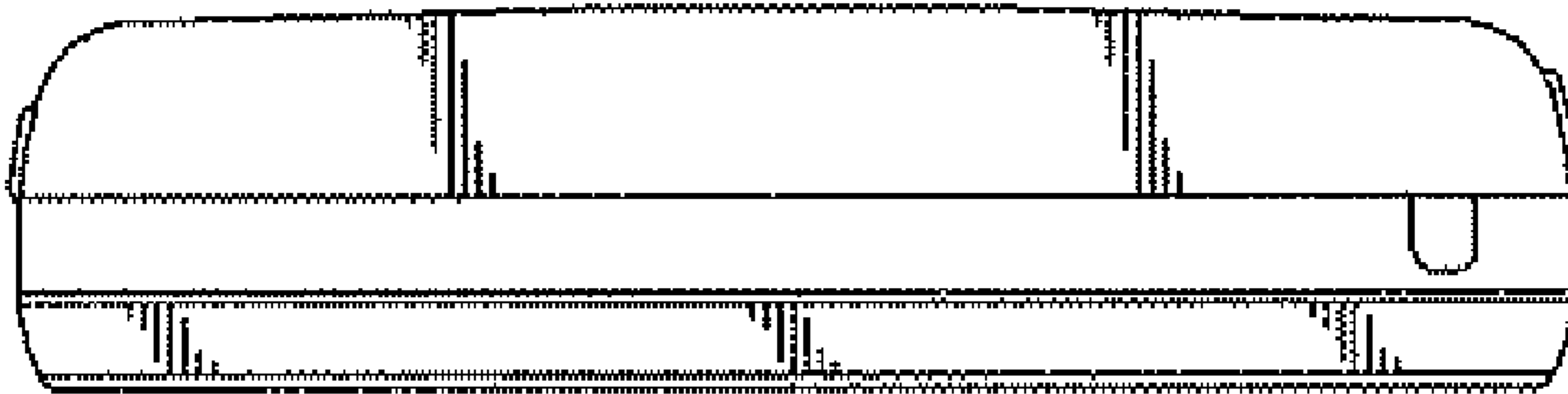

FIG. 7

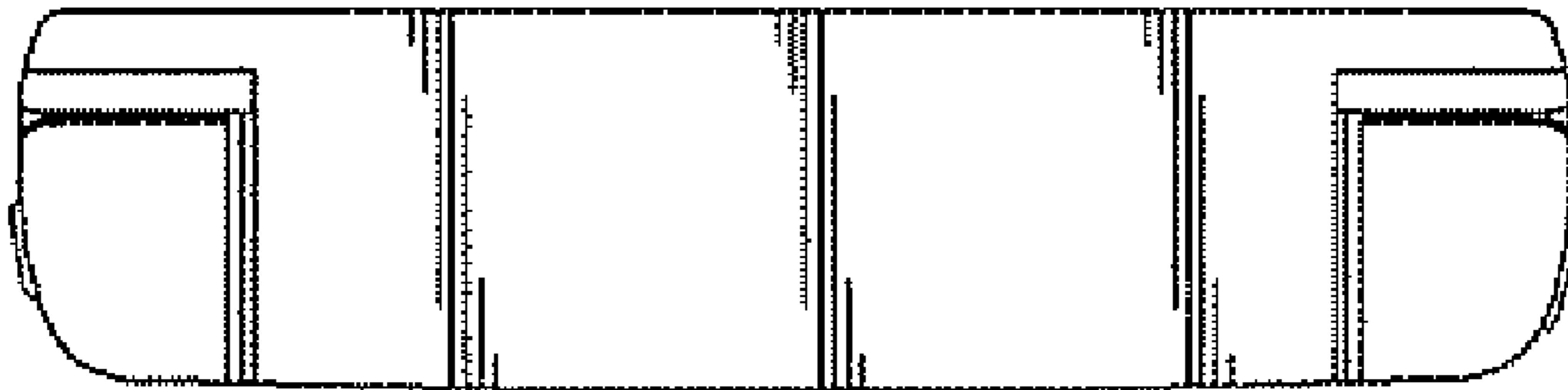

FIG. 8

