



US00D591254S

(12) **United States Design Patent**
Lim et al.

(10) **Patent No.:** **US D591,254 S**
(45) **Date of Patent:** **** Apr. 28, 2009**

(54) **CELLULAR PHONE**

(75) Inventors: **Seong Jae Lim**, Seoul (KR); **Sei Hyun Cho**, Seoul (KR)

(73) Assignee: **LG Electronics Inc.**, Seoul (KR)

(**) Term: **14 Years**

(21) Appl. No.: **29/300,450**

(22) Filed: **Mar. 27, 2008**

(30) **Foreign Application Priority Data**

Oct. 6, 2007 (KR) 30-2007-0041627

(51) **LOC (9) Cl.** **14-03**

(52) **U.S. Cl.** **D14/138 AA; D14/138 AB**

(58) **Field of Classification Search** **D14/138 AB,**
D14/138 AA, 496, 341-347; 455/575.3,
455/575.1

See application file for complete search history.

(56) **References Cited**

U.S. PATENT DOCUMENTS

- D392,968 S * 3/1998 Johansson D14/144
- D498,735 S * 11/2004 Chen et al. D14/138 AA
- D519,094 S * 4/2006 Helin D14/138 AA
- D537,064 S * 2/2007 Kim et al. D14/138 AA
- D538,773 S * 3/2007 Jung D14/138 AA
- D543,171 S * 5/2007 Kim et al. D14/138 AA
- D552,584 S * 10/2007 Lee D14/138 AA
- D555,624 S * 11/2007 Lee et al. D14/138 AA
- D557,240 S * 12/2007 Lee et al. D14/138 AB
- D557,674 S * 12/2007 Lee et al. D14/138 AB
- D558,178 S * 12/2007 Kim et al. D14/138 AA
- D558,719 S * 1/2008 Choi et al. D14/138 AA
- D560,642 S * 1/2008 Yun et al. D14/138 AA
- D560,645 S * 1/2008 Park D14/138 AA
- D563,371 S * 3/2008 Kim et al. D14/138 AA
- D565,017 S * 3/2008 Kim et al. D14/138 AA
- 7,398,114 B2 * 7/2008 Gartrell 455/575.8
- D574,347 S * 8/2008 Lee et al. D14/138 AA

- D583,343 S * 12/2008 Lee et al. D14/138 AA
- D583,348 S * 12/2008 Lee et al. D14/138 AA
- D583,790 S * 12/2008 Son et al. D14/138 AB
- 2005/0090298 A1 * 4/2005 Park et al. 455/575.4
- 2007/0026907 A1 * 2/2007 Jeun 455/575.1
- 2008/0039156 A1 * 2/2008 Lee et al. 455/575.1

OTHER PUBLICATIONS

LG KT610 telephone, announced Feb. 2008, [online], [site visited Jan. 19, 2009]. Available from Internet ,<URL: <http://www.gsmarena.com>>.*

Toshiba G910/G920 telephone, announced Jan. 2008, [online], [site visited Jan. 19, 2009]. Available from Internet ,<URL: <http://www.gsmarena.com>>.*

Motorola W208 telephone, announced Jun. 2006, [online], [site visited Jan. 19, 2009]. Available from Internet ,<URL: <http://www.gsmarena.com>>.*

* cited by examiner

Primary Examiner—Jeffrey D Asch

(74) *Attorney, Agent, or Firm*—Morgan Lewis & Bockius LLP

(57) **CLAIM**

The ornamental design for a cellular phone, as shown and described.

DESCRIPTION

FIG. 1 is a top, front perspective of the cellular phone showing our new design;

FIG. 2 is a front view thereof;

FIG. 3 is a rear view thereof;

FIG. 4 is a left side view thereof;

FIG. 5 is a right side view thereof;

FIG. 6 is a top plan view thereof;

FIG. 7 is a bottom plan view thereof;

FIG. 8 is a front view in an open position thereof; and,

FIG. 9 is a top view in an open position thereof.

1 Claim, 5 Drawing Sheets

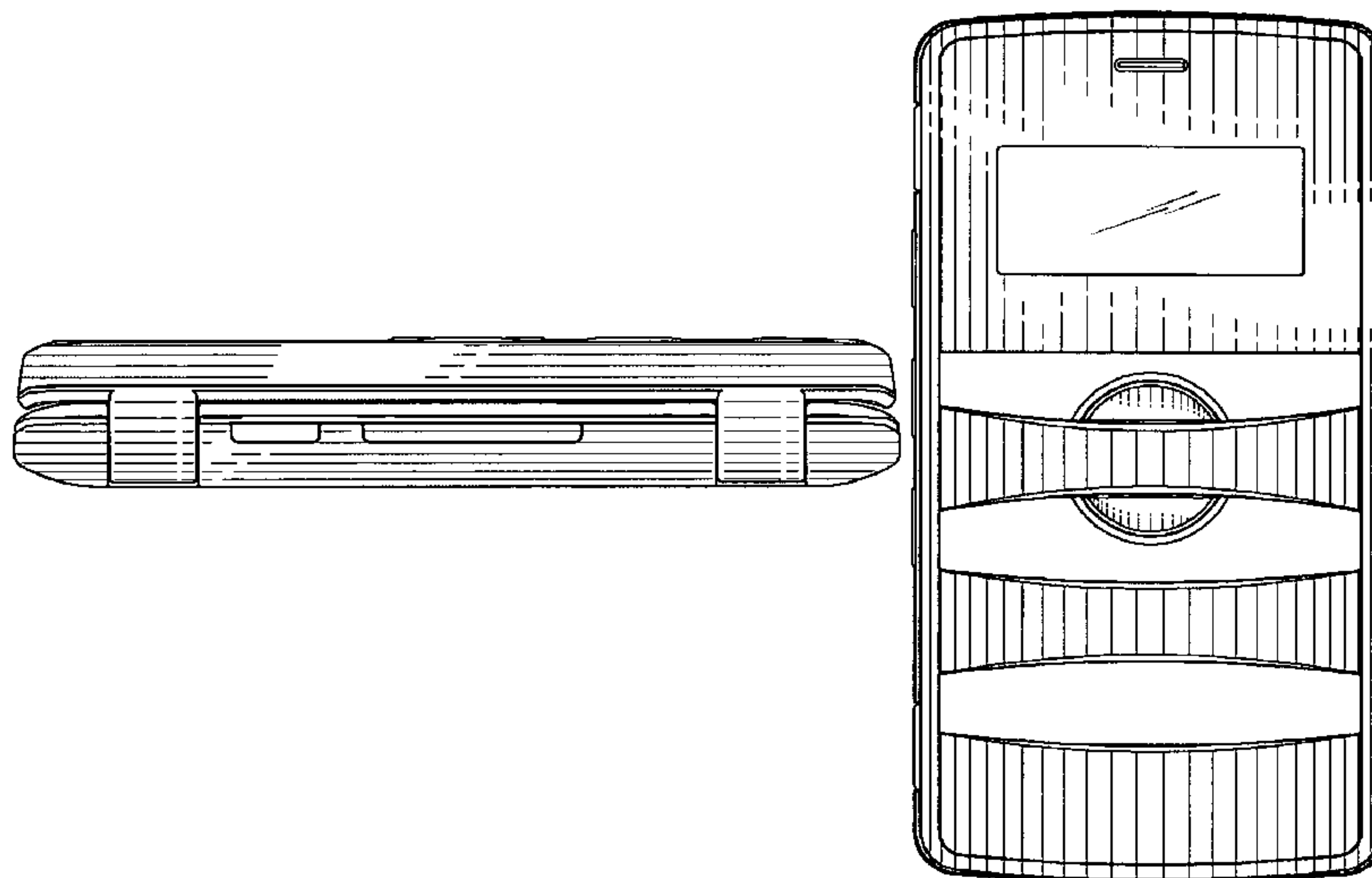

Fig. 1

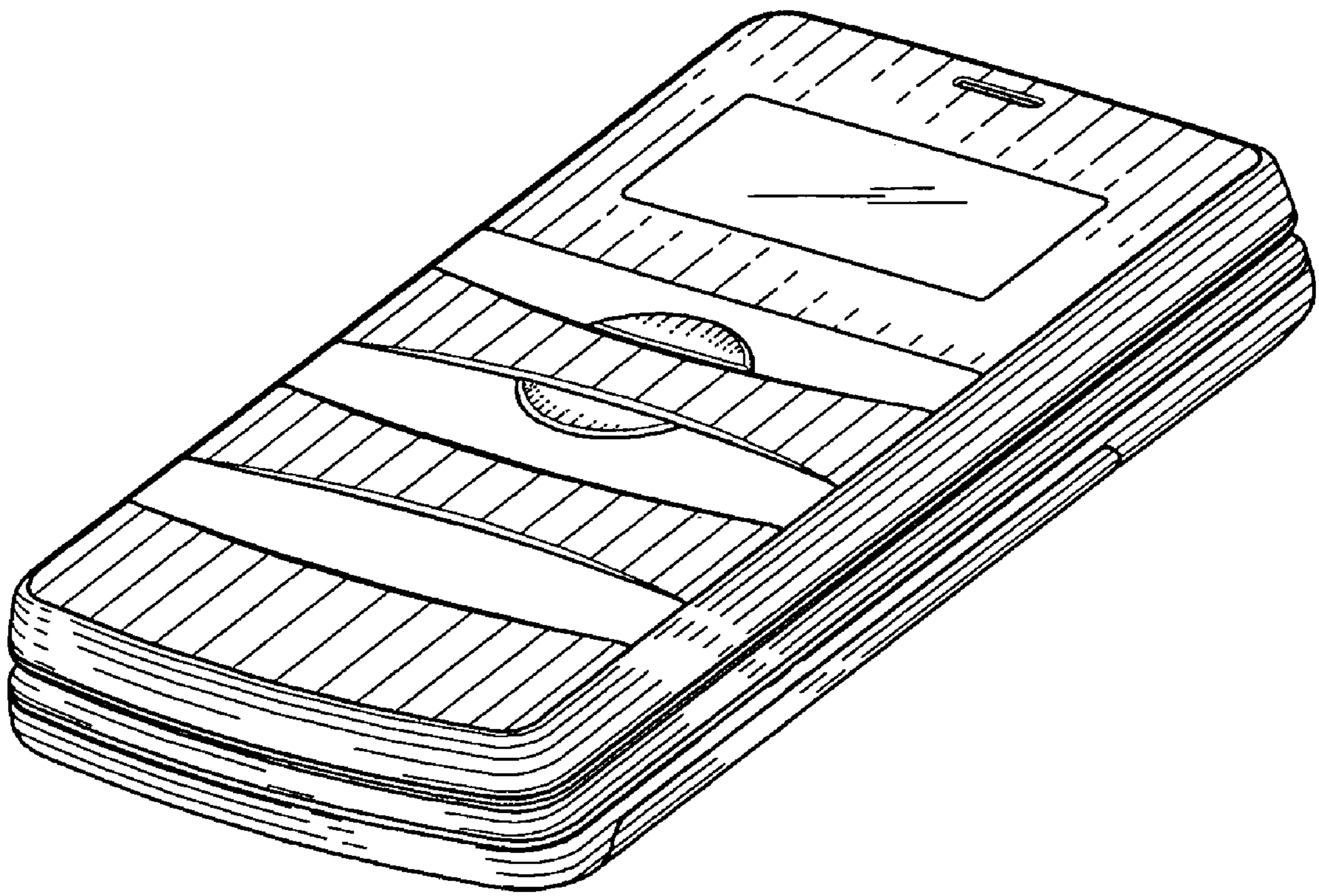

Fig. 2

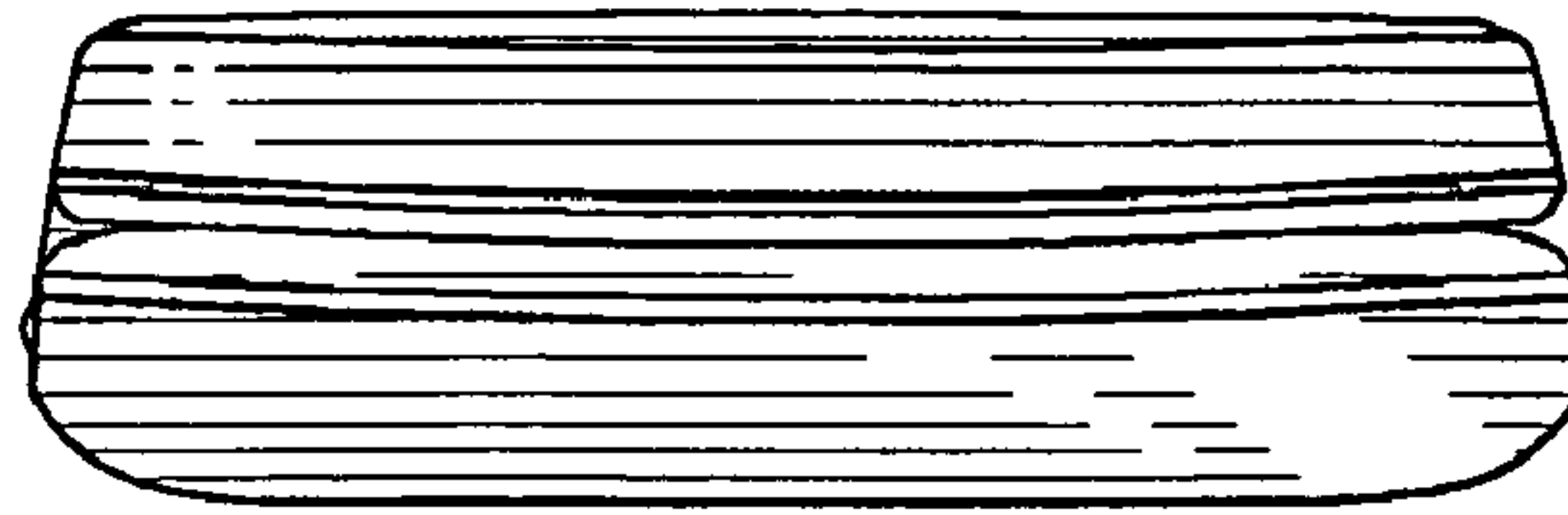

Fig. 3

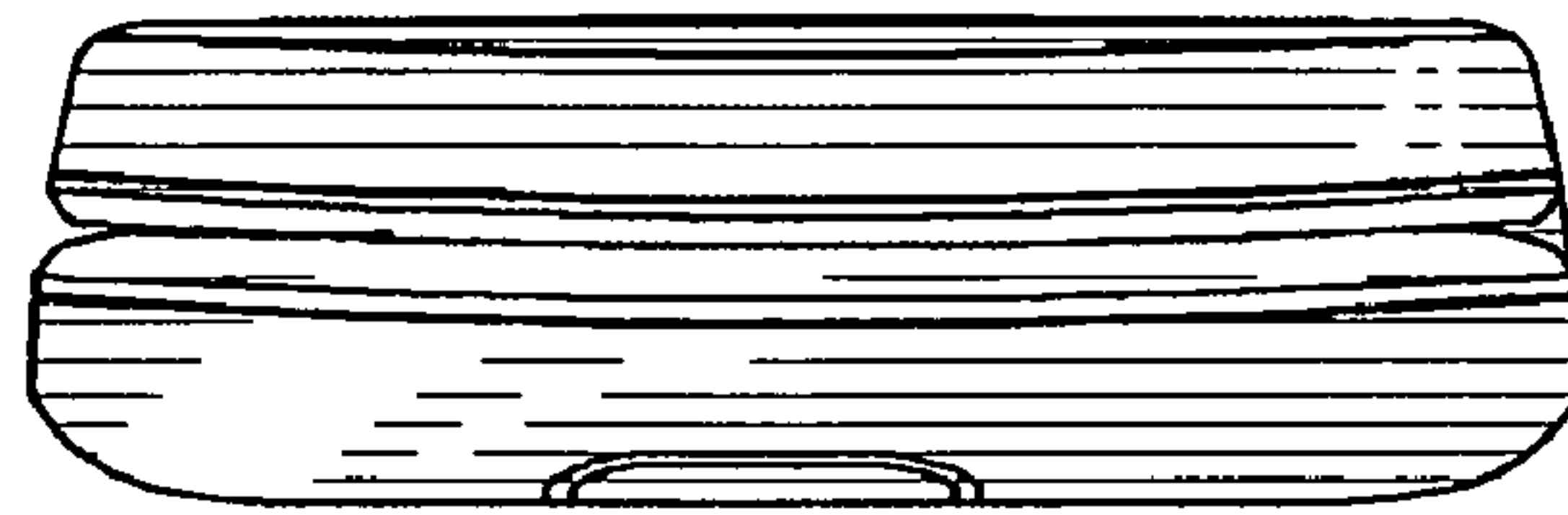

Fig. 4

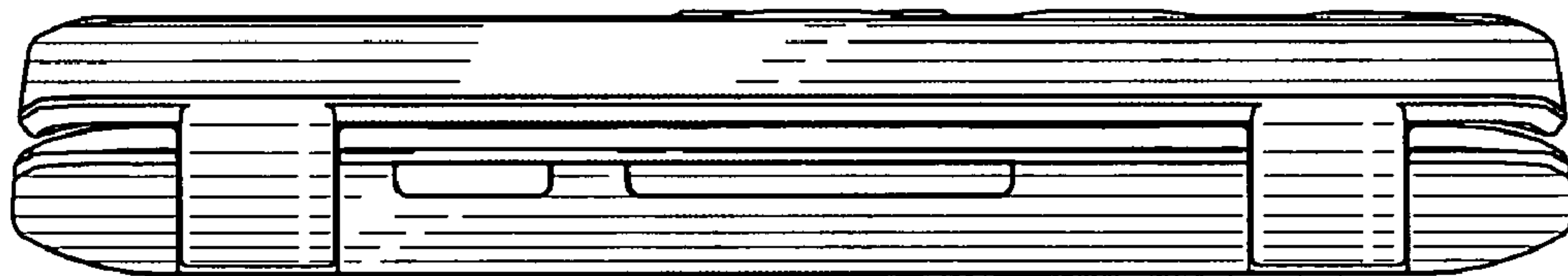

Fig. 5

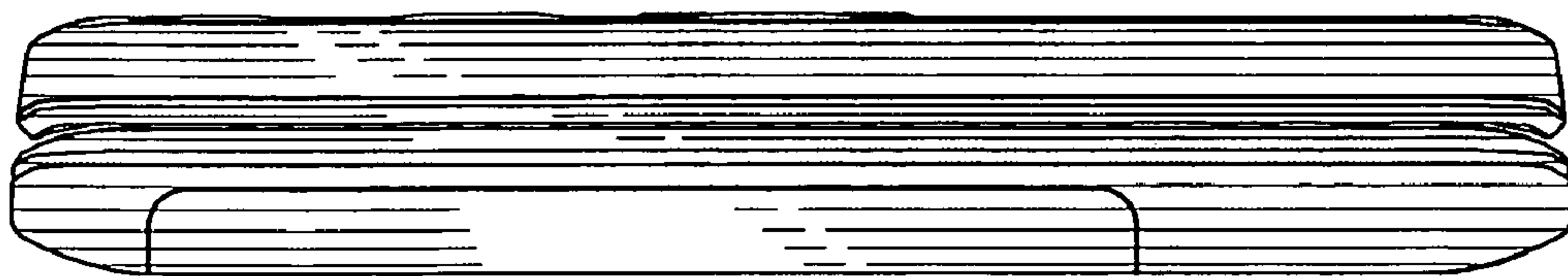

Fig. 6

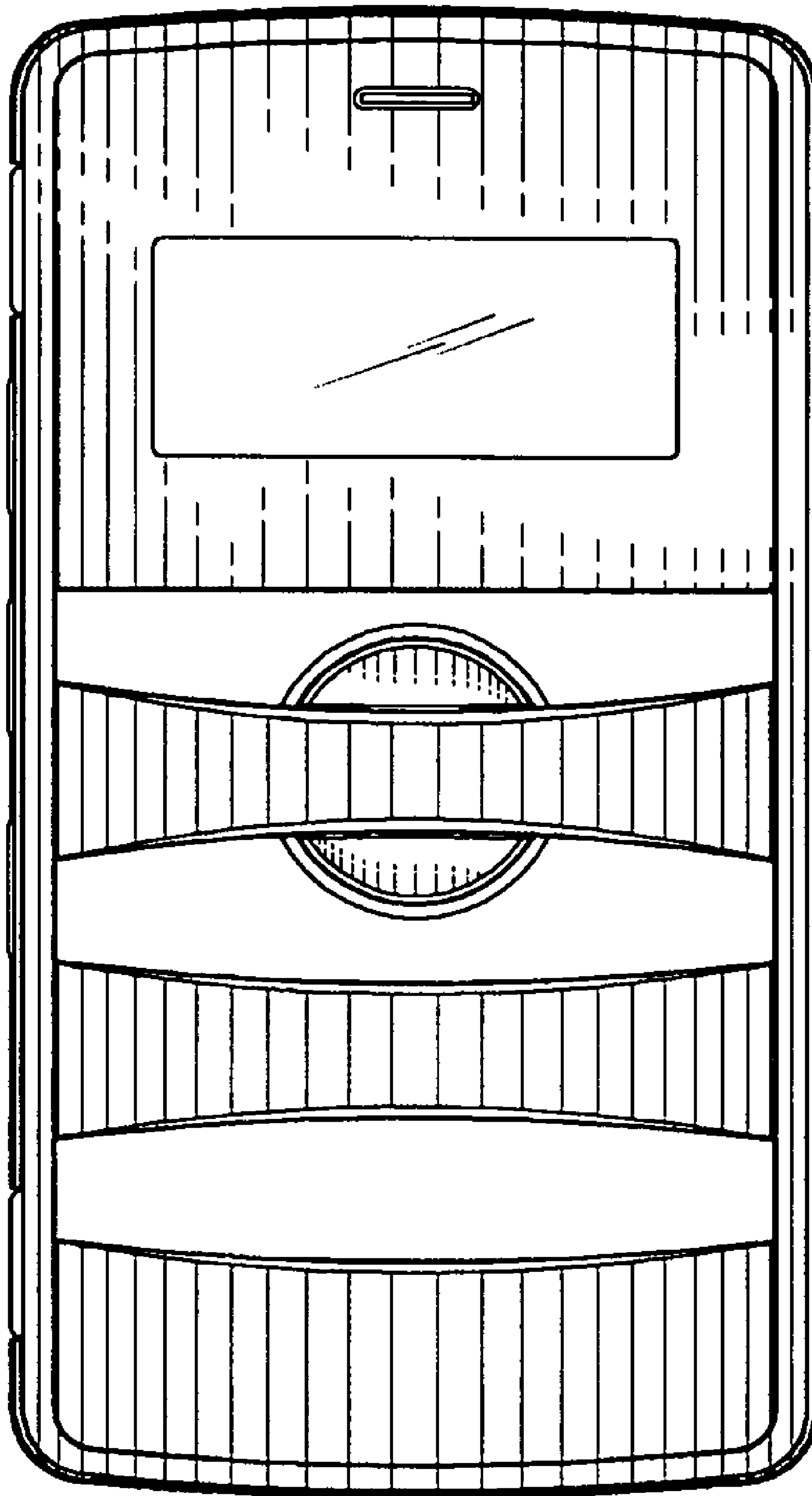

Fig. 7

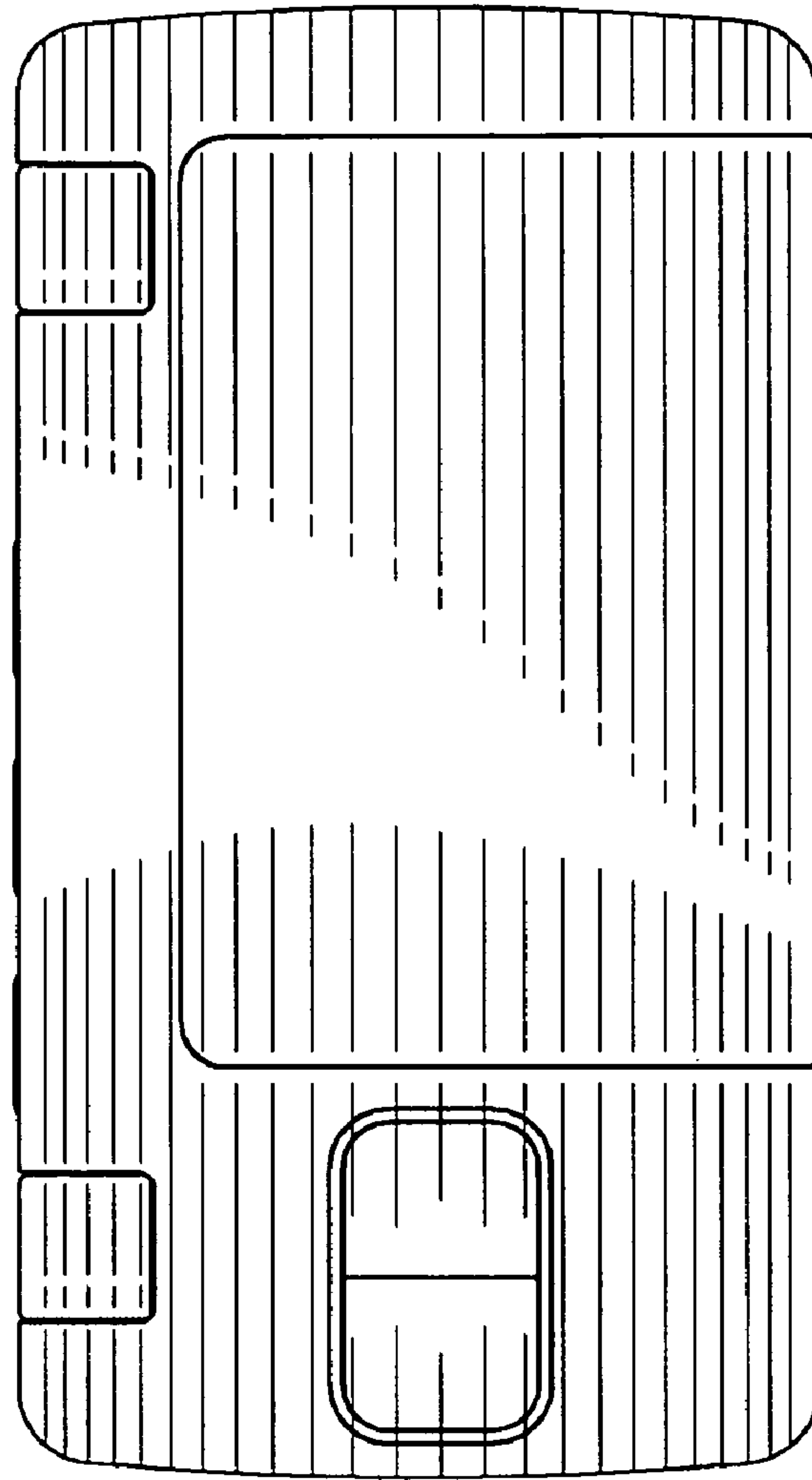

Fig. 8

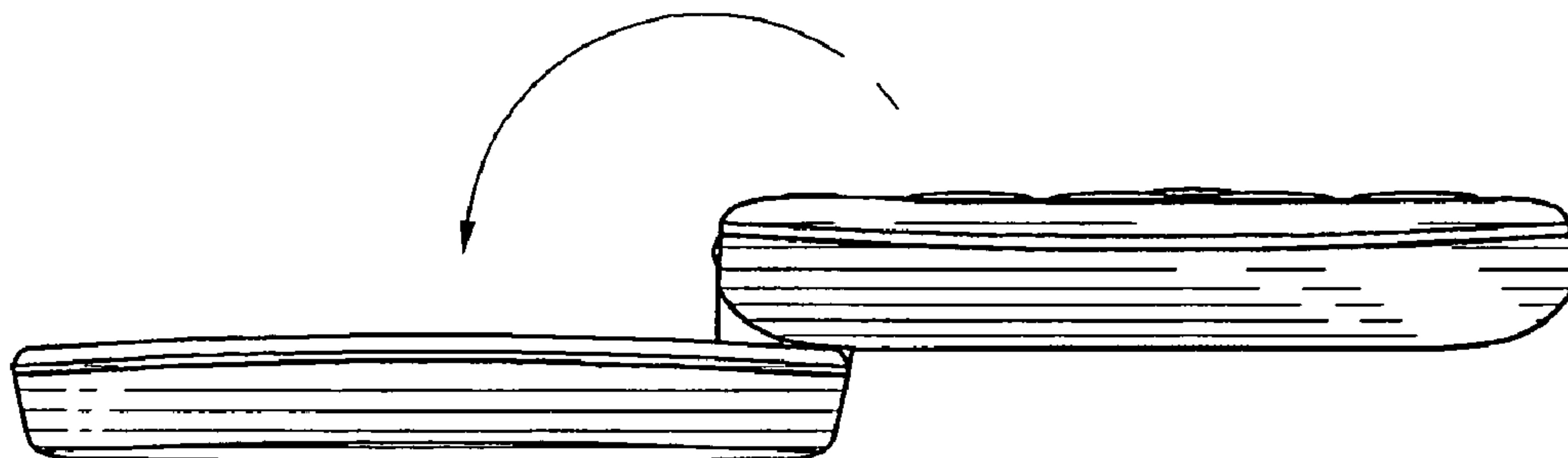

Fig. 9

