



US00D591145S

(12) **United States Design Patent**  
**Kosunen et al.**

(10) **Patent No.:** **US D591,145 S**  
(45) **Date of Patent:** **\*\* Apr. 28, 2009**

(54) **CLAMPING SLEEVE FOR TELESCOPIC SHAFT**

DE 100 54 612 4/2001  
EP 0 641 578 3/1995

(75) Inventors: **Riikka Kosunen**, Joensuu (FI); **Riina Seppanen**, Joensuu (FI); **Jari Ristola**, Ylamyly (FI)

\* cited by examiner

*Primary Examiner*—T. Chase Nelson  
*Assistant Examiner*—John Windmuller

(73) Assignee: **Exel Oyj** (FI)

(74) *Attorney, Agent, or Firm*—Andrus, Scales, Starke & Sawall, LLP

(\*\*) Term: **14 Years**

(21) Appl. No.: **29/259,491**

(57) **CLAIM**

(22) Filed: **May 9, 2006**

The ornamental design for a clamping sleeve for telescopic shaft, as shown and described.

(51) **LOC (9) Cl.** ..... **08-08**

**DESCRIPTION**

(52) **U.S. Cl.** ..... **D8/396**

(58) **Field of Classification Search** ..... D8/356,  
D8/394–396, 371; 24/570, 67.9; 403/102,  
403/109.8; 248/74.2, 215, 227.1, 49, 300,  
248/301, 316.7, 51, 489

FIG. 1 is a side view of the clamping sleeve of the present invention, an environment in which the clamping sleeve may be used being shown in broken lines;

See application file for complete search history.

FIG. 2 is a perspective view of the clamping sleeve;

(56) **References Cited**

FIG. 3 is a view of one side of the clamping sleeve;

**U.S. PATENT DOCUMENTS**

FIG. 4 is a view of the clamping sleeve from right when the clamping sleeve is oriented as shown in FIG. 3;

5,478,117 A \* 12/1995 Quintana et al. .... 280/823

FIG. 5 is a view of the side of the clamping sleeve opposite to that shown in FIG. 3;

D419,187 S \* 1/2000 Chuang ..... D19/36

D475,085 S \* 5/2003 Whitehorn ..... D19/36

7,029,197 B2 \* 4/2006 Lin et al. .... 403/353

FIG. 6 is a top view of the clamping sleeve when the clamping sleeve is oriented as shown in FIG. 3; and,

2002/0076266 A1 6/2002 Mandon et al.

FIG. 7 is a bottom view of the clamping sleeve.

2005/0005862 A1 \* 1/2005 Paquette ..... 119/51.01

2006/0133889 A1 \* 6/2006 Warner ..... 403/109.4

The broken lines in FIG. 1 depict environment only and form no part of the claimed design.

2006/0158549 A1 \* 7/2006 Digweed et al. .... 348/373

**FOREIGN PATENT DOCUMENTS**

DE 2026732 12/1971

**1 Claim, 3 Drawing Sheets**

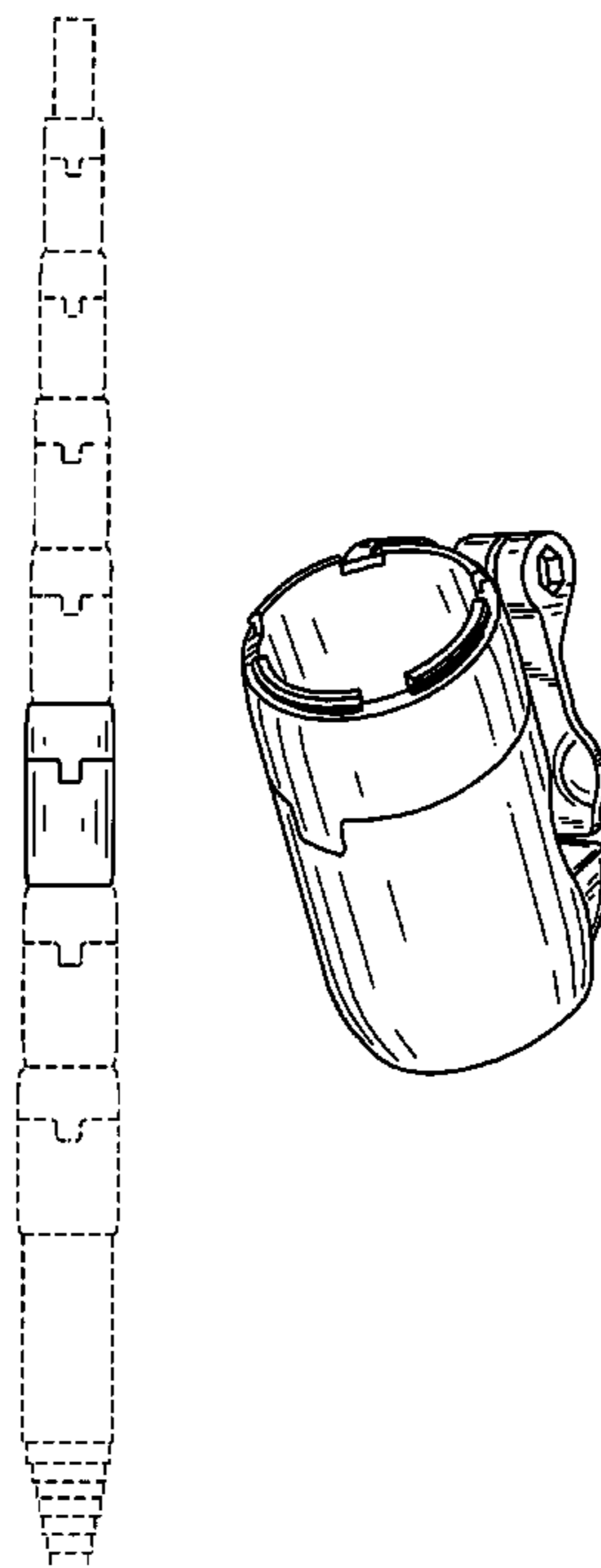

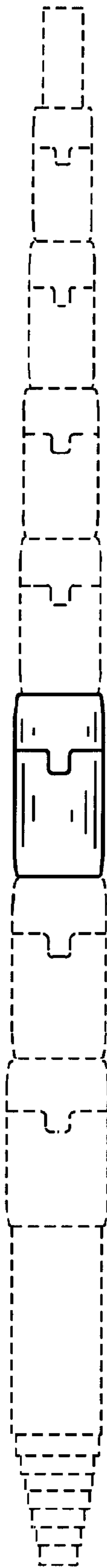

FIG. 1

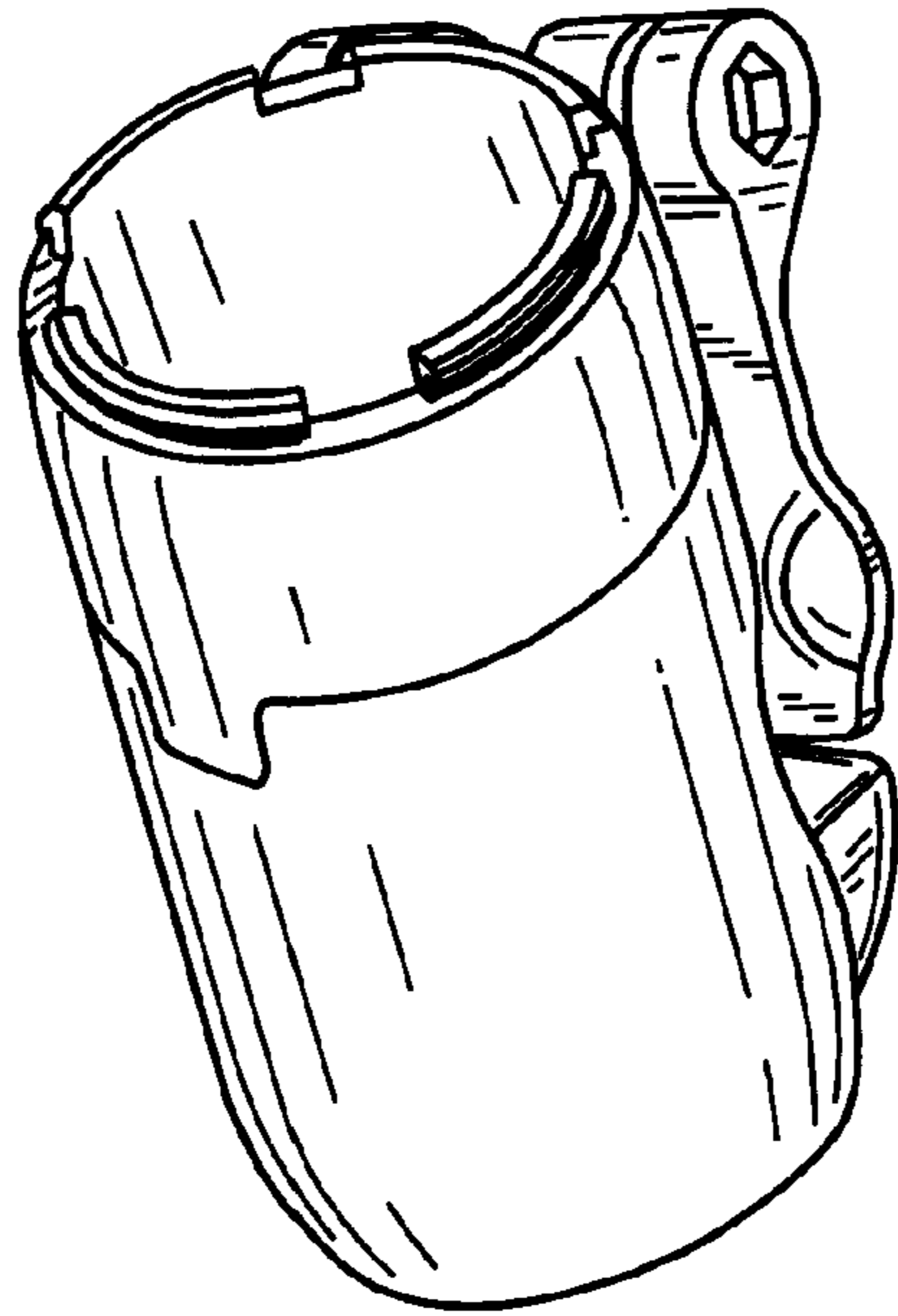

FIG. 2

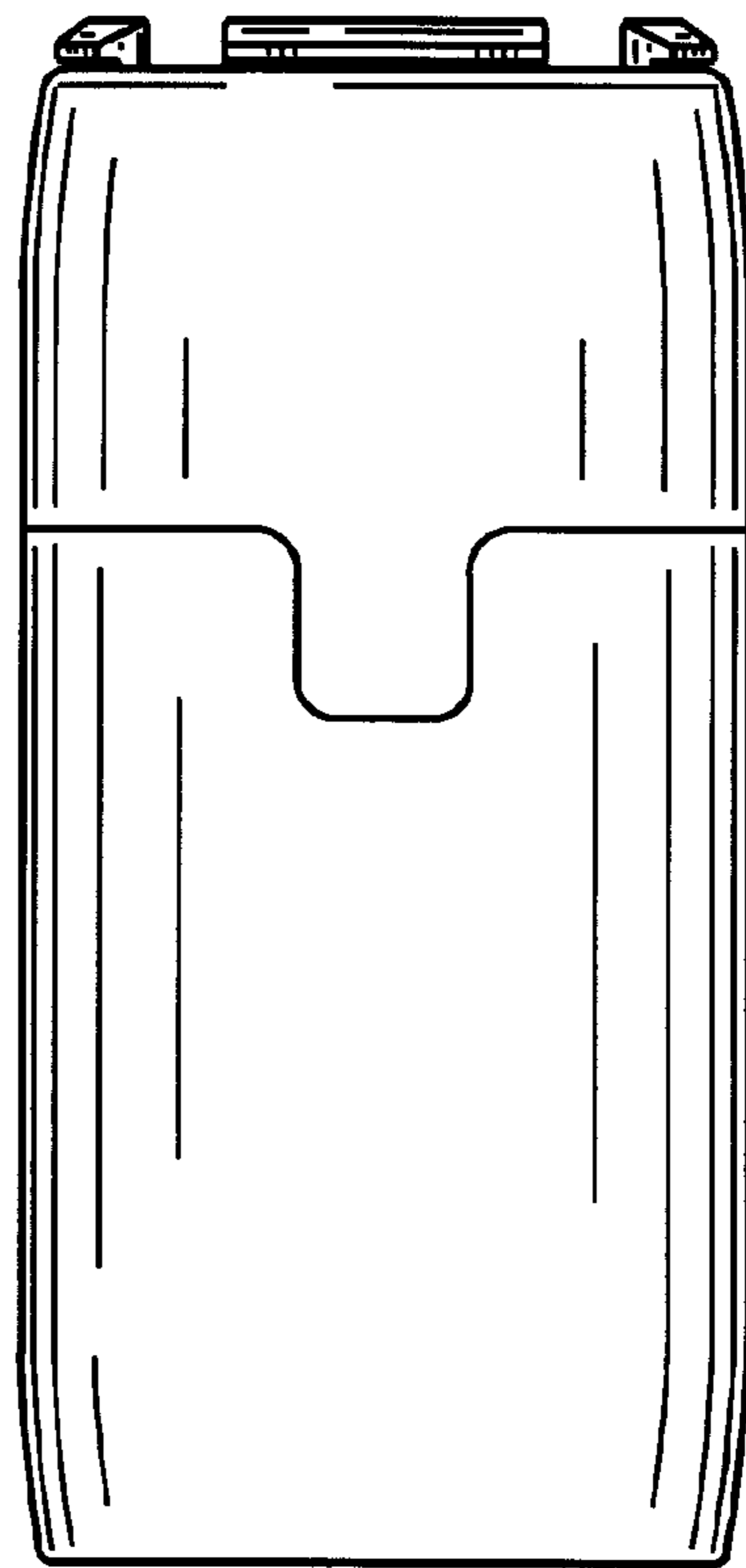

FIG. 3

FIG. 4

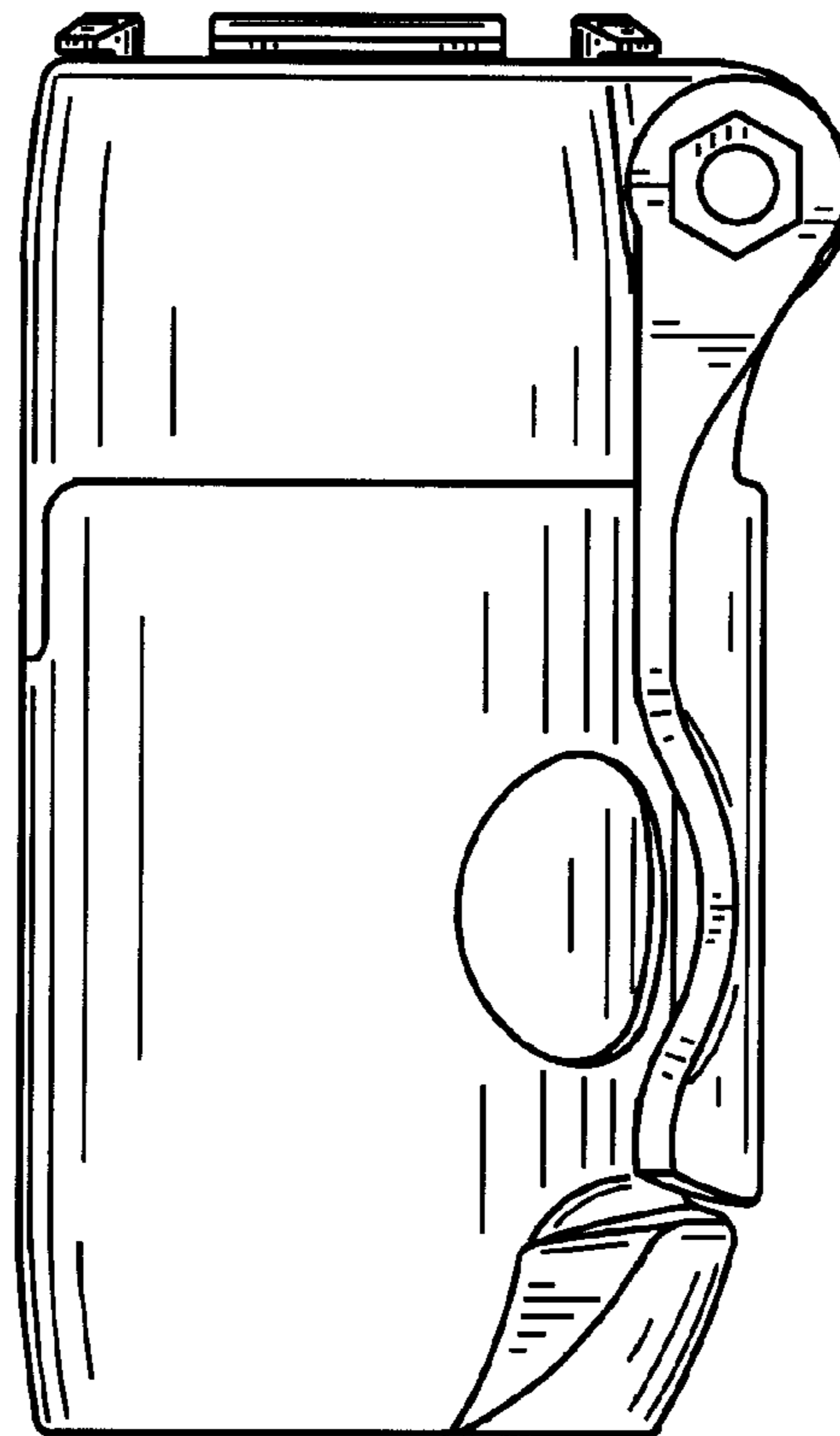

FIG. 5

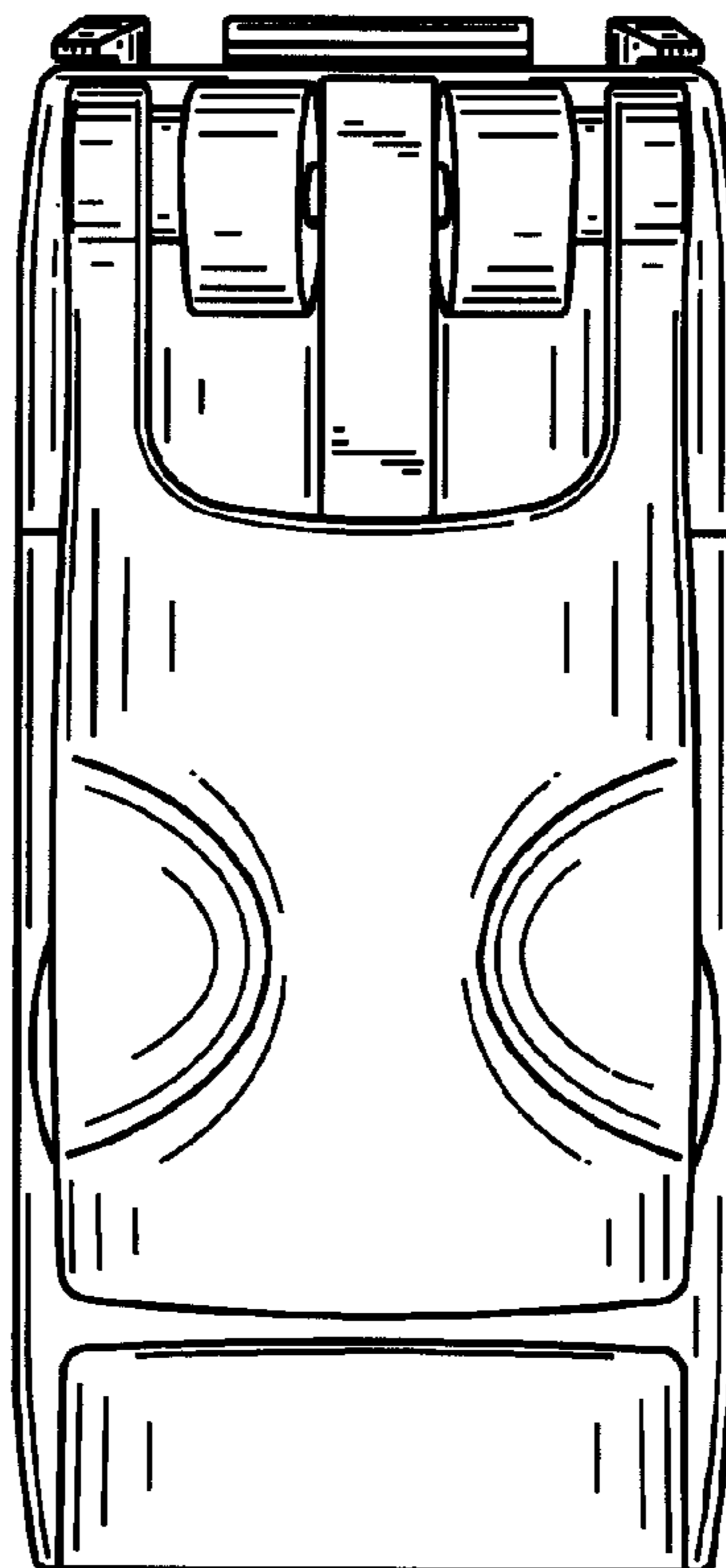

FIG. 6

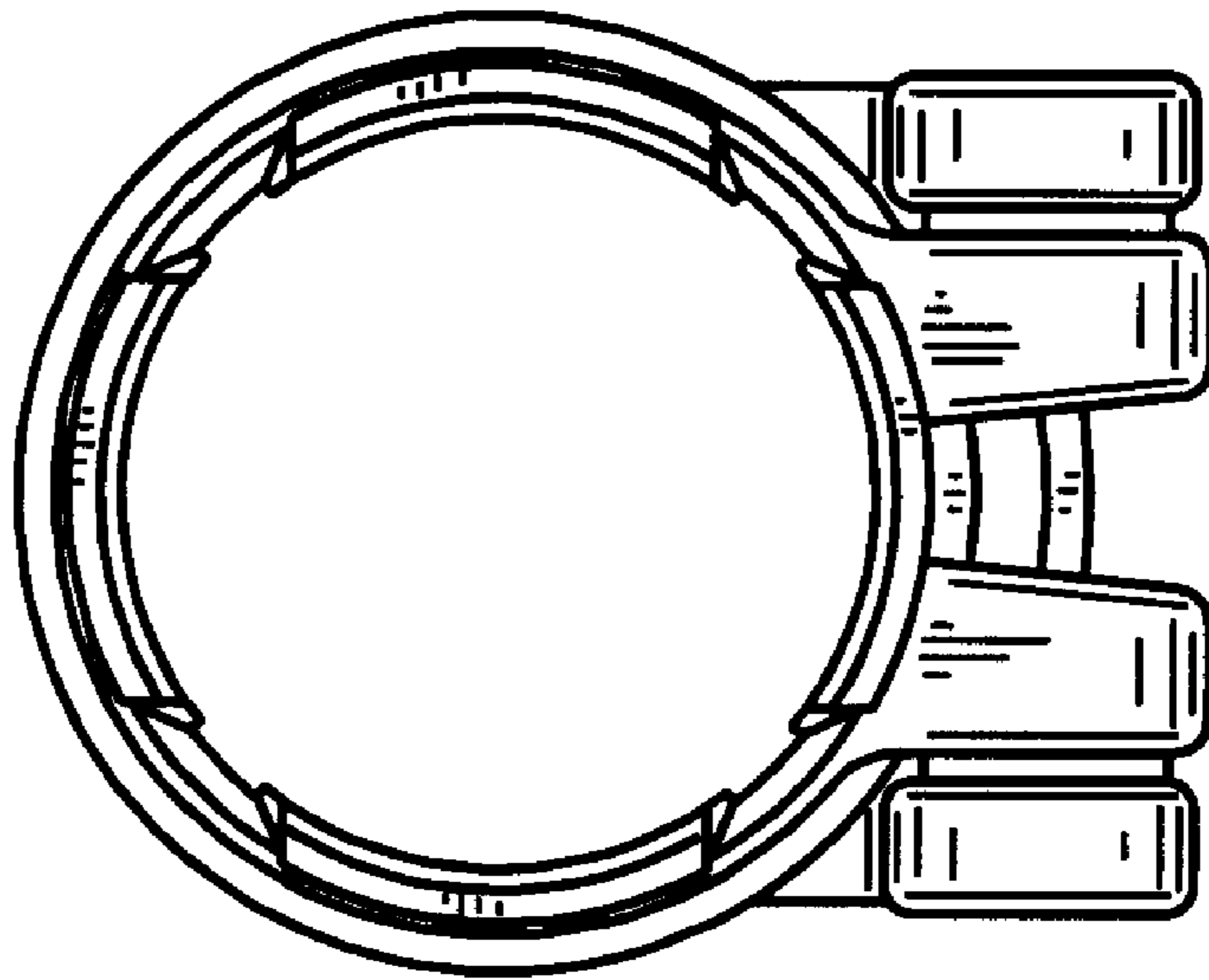

FIG. 7

