



US00D591111S

(12) **United States Design Patent**  
**Rzeczkowski**

(10) **Patent No.:** **US D591,111 S**  
(45) **Date of Patent:** **\*\* Apr. 28, 2009**

(54) **FOOD STORAGE TRAY WITH LID**

(76) Inventor: **Jayne Rzeczkowski**, 30 Orzeck Rd.,  
New Hampton, NY (US) 10958

(\*\*) Term: **14 Years**

(21) Appl. No.: **29/325,448**

(22) Filed: **Oct. 1, 2008**

(51) **LOC (9) Cl.** ..... **07-01**

(52) **U.S. Cl.** ..... **D7/548; D7/552.2; D7/553.2**

(58) **Field of Classification Search** ..... D7/500-504,  
D7/538-588; D9/424-429, 761, 500; 220/904,  
220/23.83, 574, 212, 657, 659, 755, 771,  
220/571, 641; D3/307, 310-315, 273, 276,  
D3/283; 211/128.1, 78; D28/73  
See application file for complete search history.

(56) **References Cited**

**U.S. PATENT DOCUMENTS**

D153,277 S *	4/1949	Gerber	.....	D3/311
3,057,536 A	10/1962	Warnsdorfer, Jr. et al.		
3,241,706 A	3/1966	Monaco et al.		
3,391,816 A	7/1968	Barrington		
D218,021 S	7/1970	Wentzel		
D224,554 S *	8/1972	Swett	.....	D7/629
D280,058 S *	8/1985	Carlson	.....	D7/629
4,915,251 A	4/1990	Payne		
5,027,972 A	7/1991	Bartholomew		
5,277,329 A	1/1994	Pomroy et al.		

D374,349 S *	10/1996	Cziraky et al.	.....	D3/315
D376,295 S	12/1996	Ahern, Jr. et al.		
D431,359 S *	10/2000	Lapidus	.....	D3/273
D512,836 S *	12/2005	Marnell, II	.....	D3/313
7,004,323 B1	2/2006	Symonds		
D519,736 S *	5/2006	Jones	.....	D3/311
7,326,428 B2	2/2008	Weir		
D566,473 S *	4/2008	Means	.....	D7/549
D577,489 S *	9/2008	Debowiecki	.....	D3/315

\* cited by examiner

*Primary Examiner*—Charles A Rademaker  
*Assistant Examiner*—Charles D Hanson  
(74) *Attorney, Agent, or Firm*—Kyle Fletcher

(57) **CLAIM**

The ornamental design for a food storage tray with lid, as shown and described.

**DESCRIPTION**

FIG. 1 is a front view of a food storage tray with lid, showing my new design;  
FIG. 2 is a rear view thereof;  
FIG. 3 is a side view thereof;  
FIG. 4 is a top view thereof;  
FIG. 5 is a bottom view thereof; and,  
FIG. 6 is a side perspective view thereof.

**1 Claim, 5 Drawing Sheets**

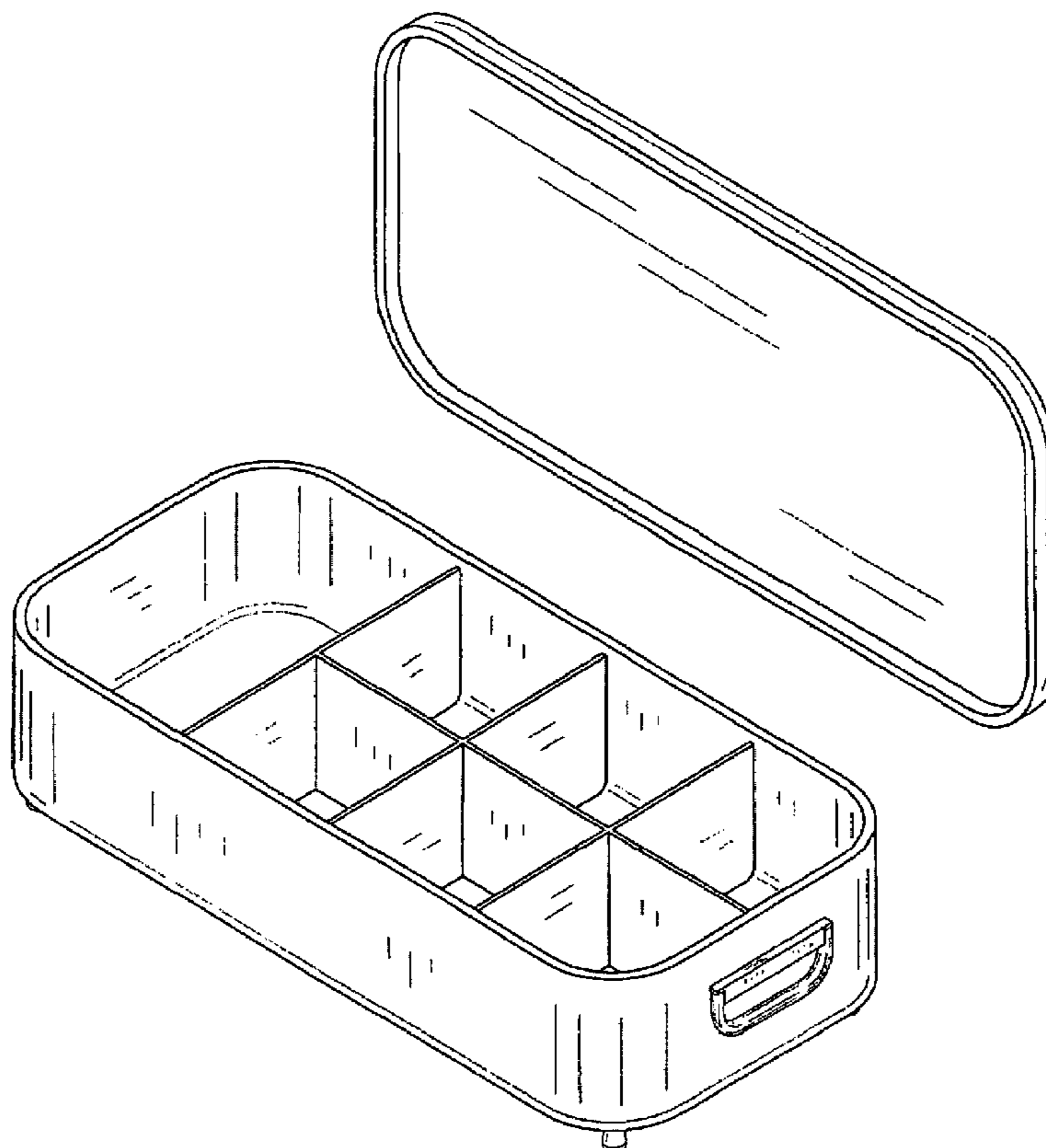

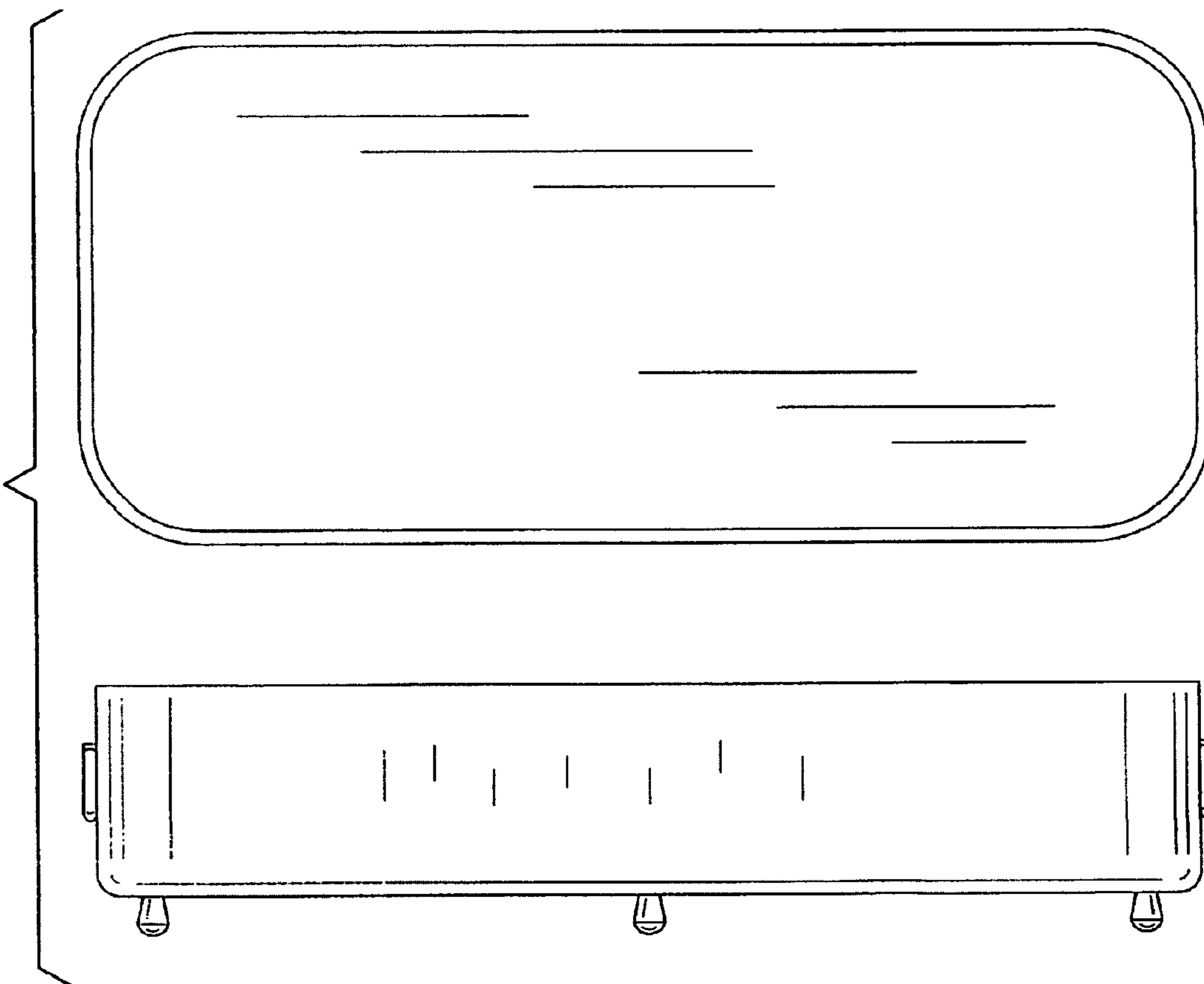

FIG. 1

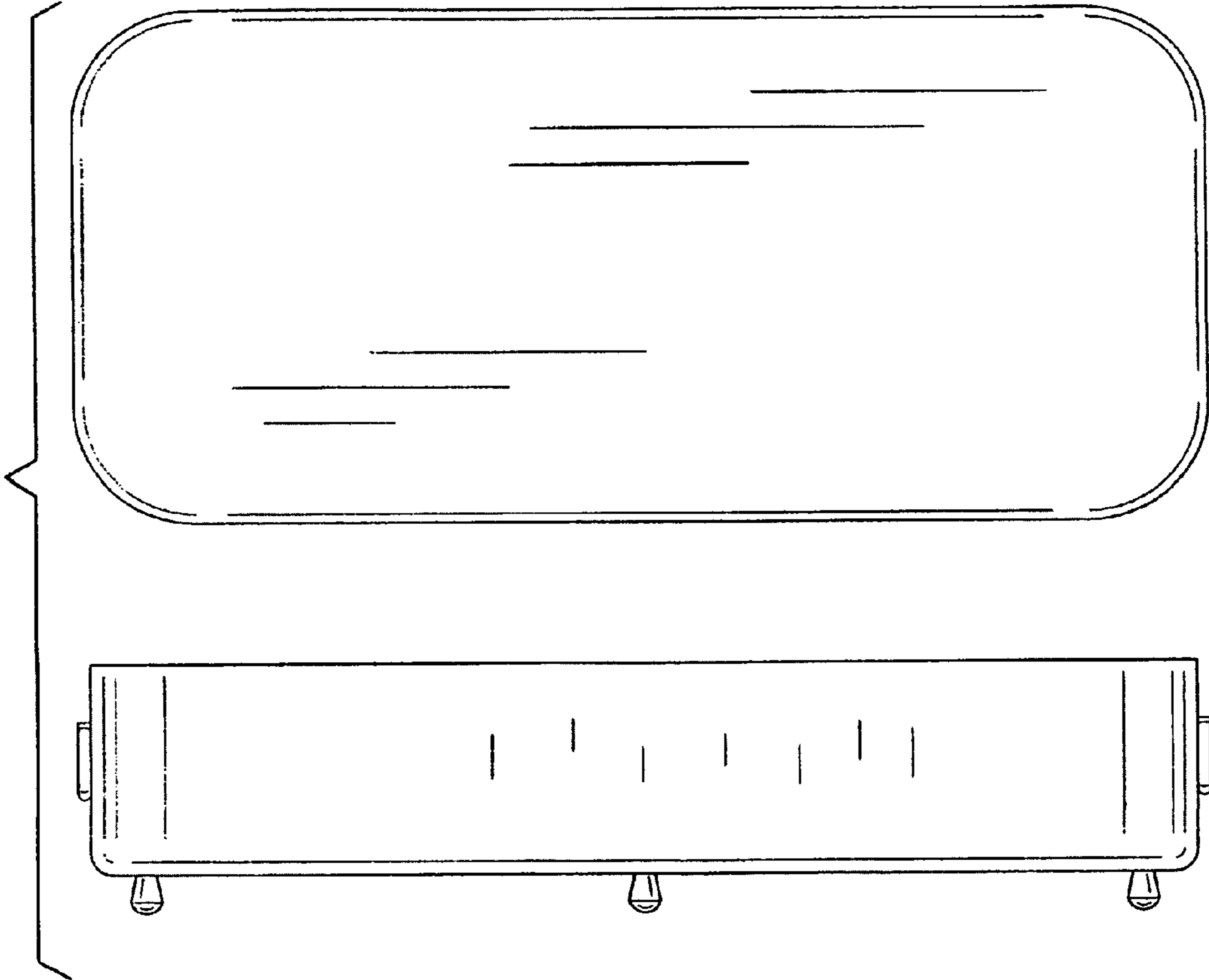
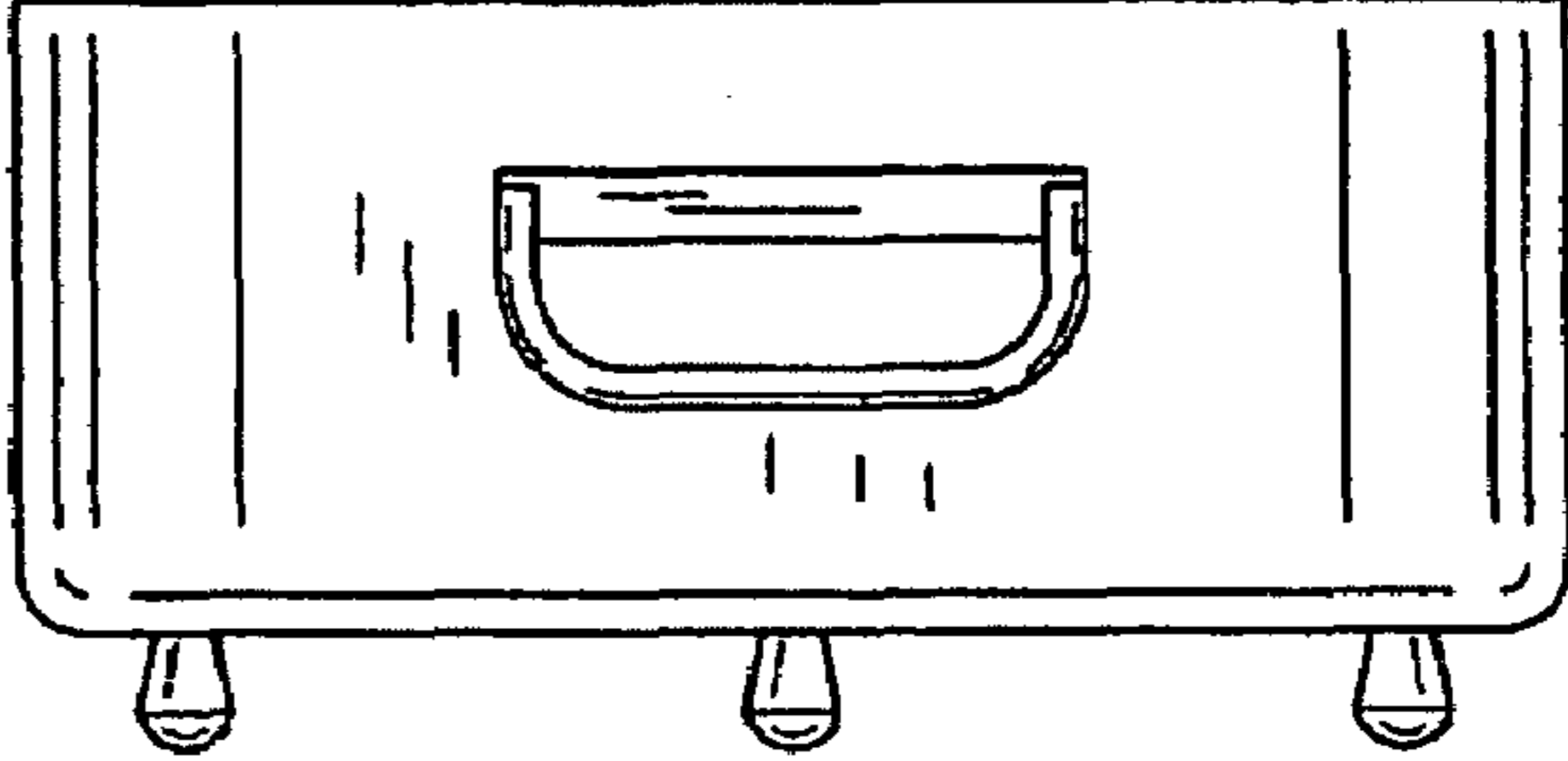
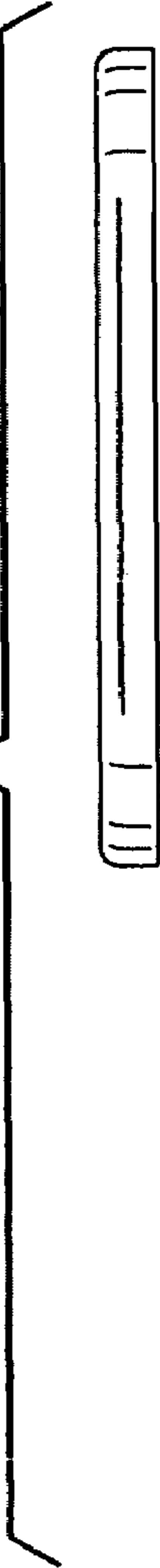

FIG. 2

FIG. 3



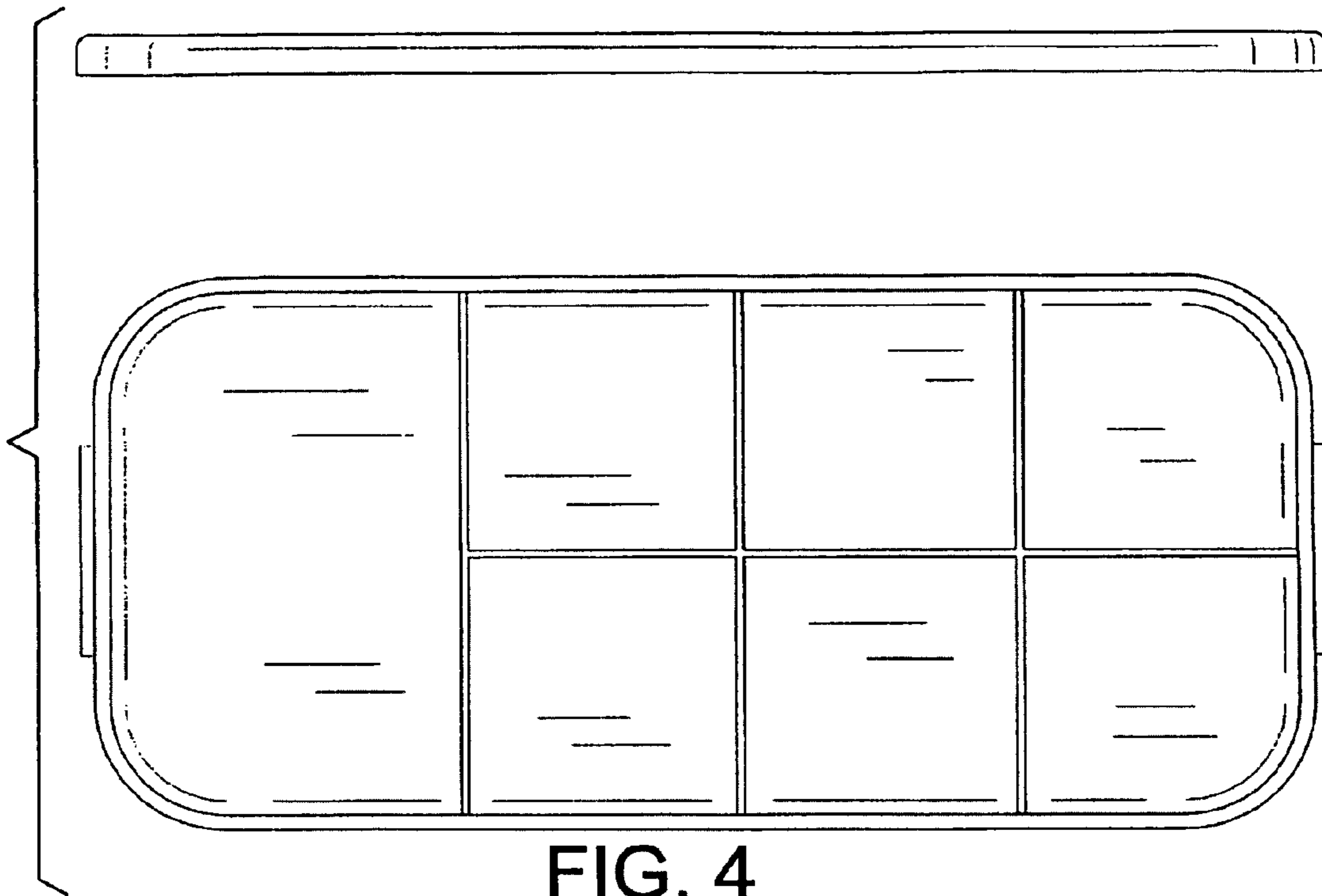

FIG. 4

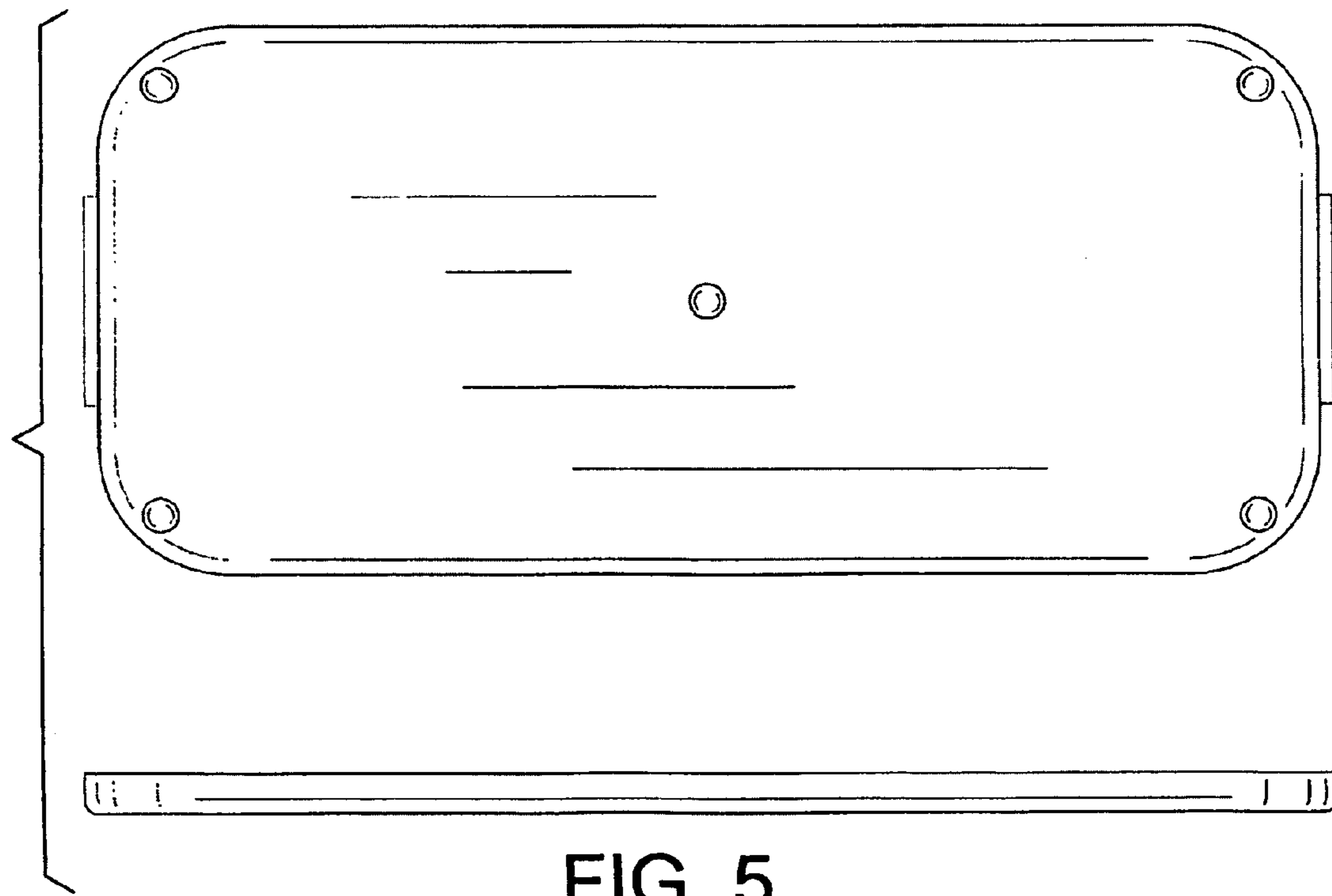

FIG. 5

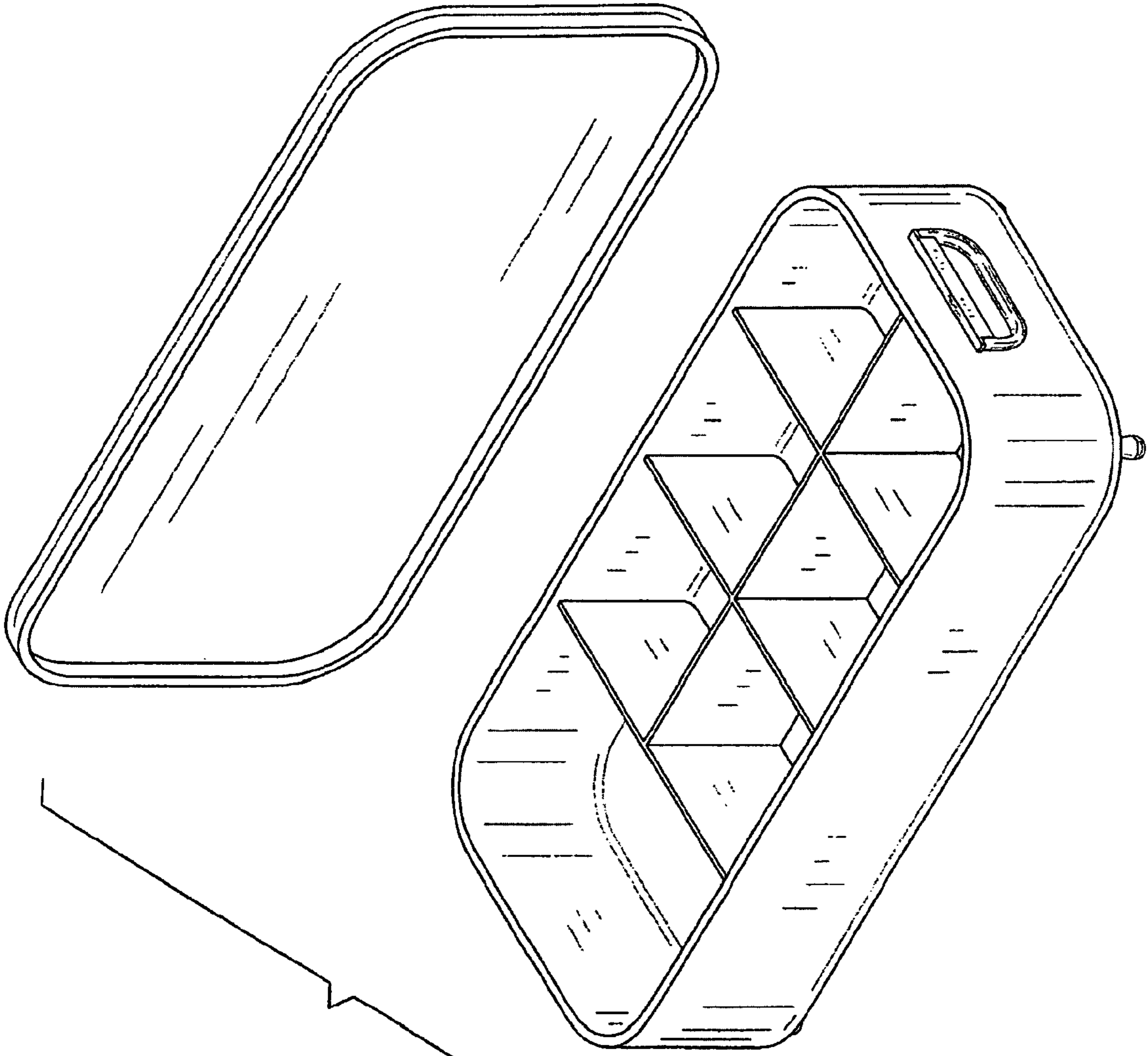

FIG. 6