



US00D591088S

(12) **United States Design Patent**
Belokin

(10) **Patent No.:** **US D591,088 S**

(45) **Date of Patent:** **** Apr. 28, 2009**

(54) **DISPLAY TRAY**

(75) **Inventor:** **Paul Belokin**, Denton County, TX (US)

(73) **Assignee:** **Displays by Martin Paul, Inc.**, Denton, TX (US)

(**) **Term:** **14 Years**

(21) **Appl. No.:** **29/313,194**

(22) **Filed:** **Dec. 16, 2008**

(51) **LOC (9) Cl.** **06-04**

(52) **U.S. Cl.** **D6/476**

(58) **Field of Classification Search** D6/475-476,
D6/455-458, 510-511, 469; 211/13, 163,
211/54.1, 57.1, 59.1, 31, 11; 108/59, 91,
108/106-107, 110, 144, 153, 180; 248/65,
248/166

See application file for complete search history.

(56) **References Cited**

U.S. PATENT DOCUMENTS

2,170,709	A	*	8/1939	Cutrow	206/1.8
D322,989	S	*	1/1992	Wood	D19/75
D331,337	S	*	12/1992	Krinke et al.	D6/467
D347,419	S	*	5/1994	Jackson	D12/414.1
D365,229	S	*	12/1995	Story et al.	D6/471
D410,359	S	*	6/1999	Belokin et al.	D6/574
5,913,433	A	*	6/1999	Belokin et al.	211/90.01
D412,421	S	*	8/1999	Belokin et al.	D6/574
D413,036	S	*	8/1999	Belokin et al.	D6/574

D413,473	S	*	9/1999	Belokin et al.	D6/574
D413,474	S	*	9/1999	Belokin et al.	D6/574
6,571,967	B2	*	6/2003	Belokin et al.	211/71.01
D547,973	S	*	8/2007	Brown et al.	D6/476
D547,992	S	*	8/2007	Belokin	D6/574
D563,710	S	*	3/2008	Belokin et al.	D6/574
D585,217	S	*	1/2009	Lussier et al.	D6/467

* cited by examiner

Primary Examiner—Elizabeth A Albert

Assistant Examiner—Kelley A Donnelly

(74) *Attorney, Agent, or Firm*—Jack A. Kanz

(57) **CLAIM**

The ornamental design for a display tray, as shown and described.

DESCRIPTION

FIG. 1 is a front perspective view of a display tray showing my new design;

FIG. 2 is a front elevational view thereof;

FIG. 3 is a side elevational view of the right-hand side thereof, the left-hand side elevational view being a mirror image of FIG. 3;

FIG. 4 is a rear elevational view;

FIG. 5 is a top plan view thereof; and,

FIG. 6 is a bottom plan view of my new design for a display tray.

1 Claim, 4 Drawing Sheets

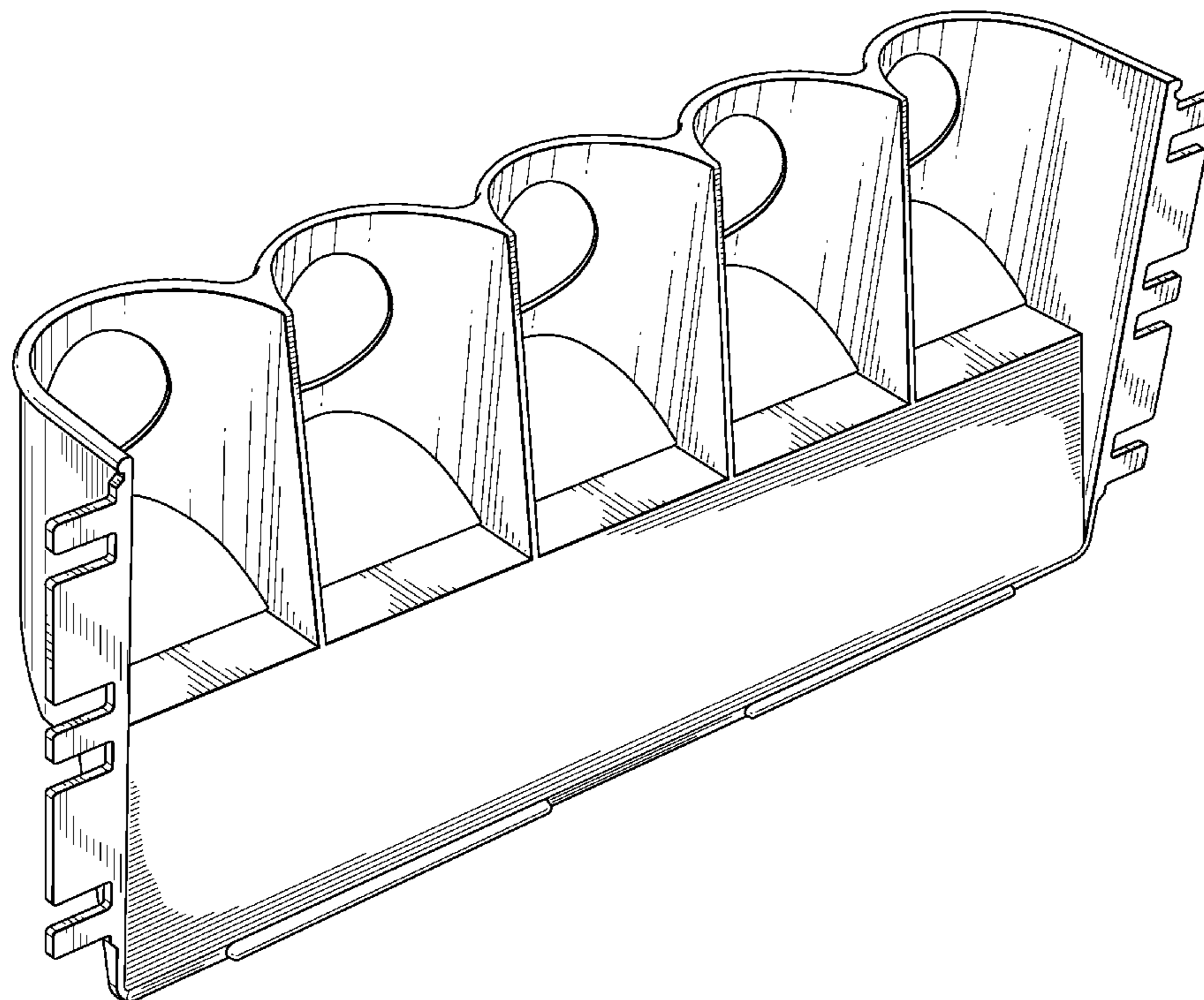

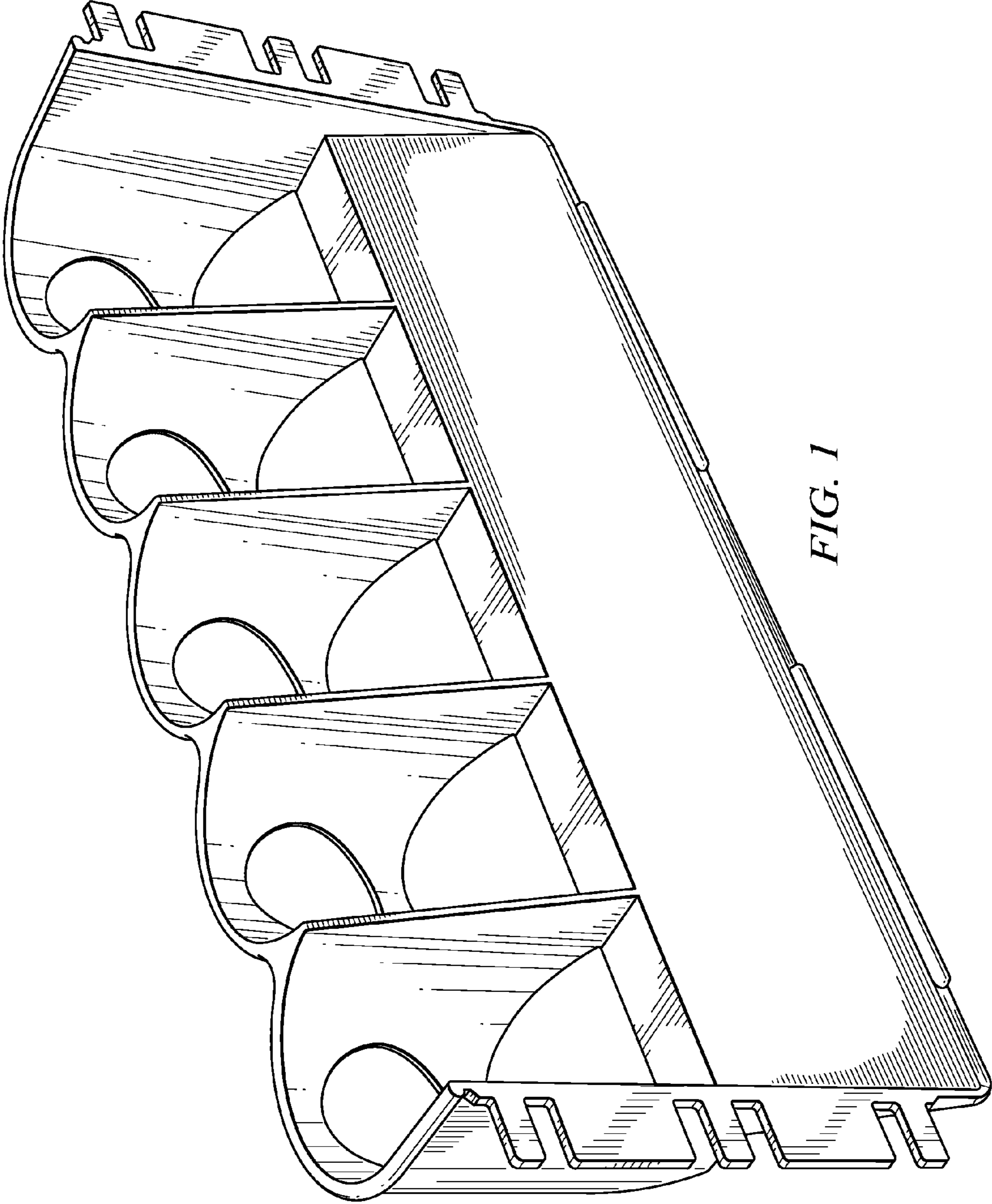

FIG. 1

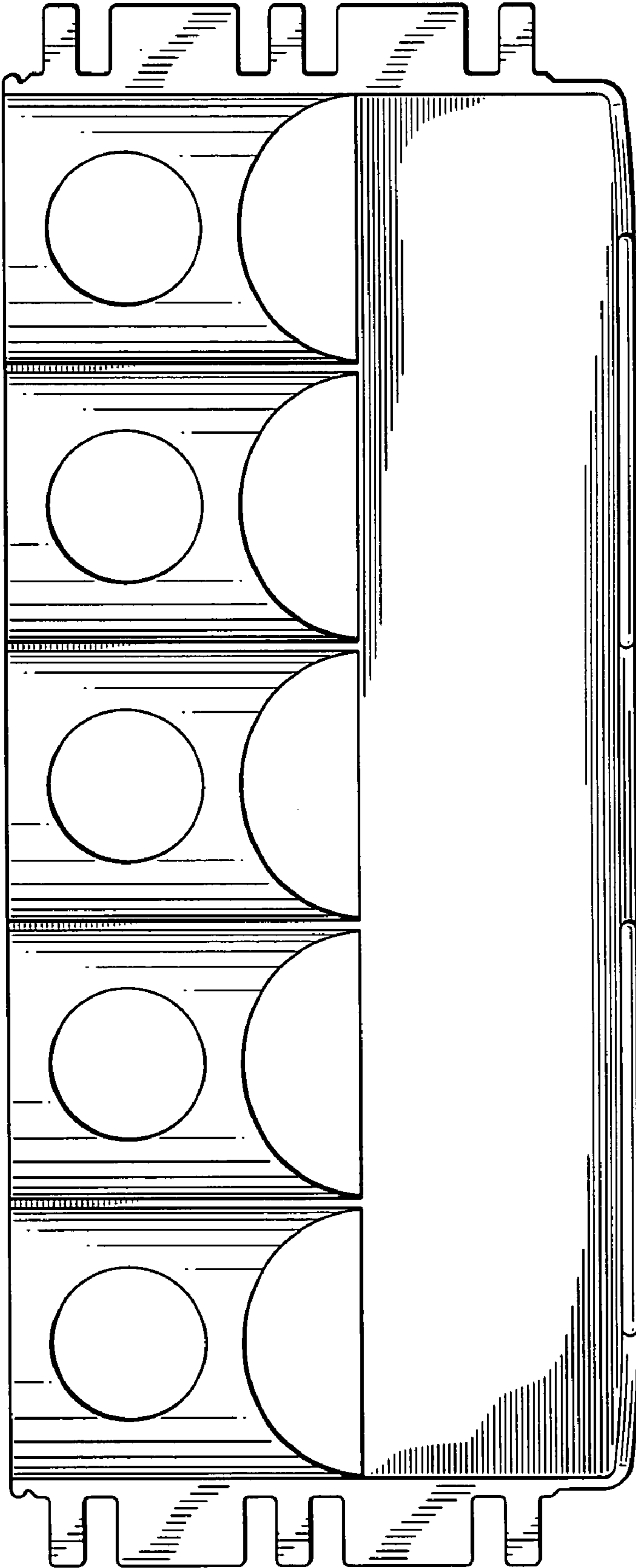

FIG. 2

FIG. 3

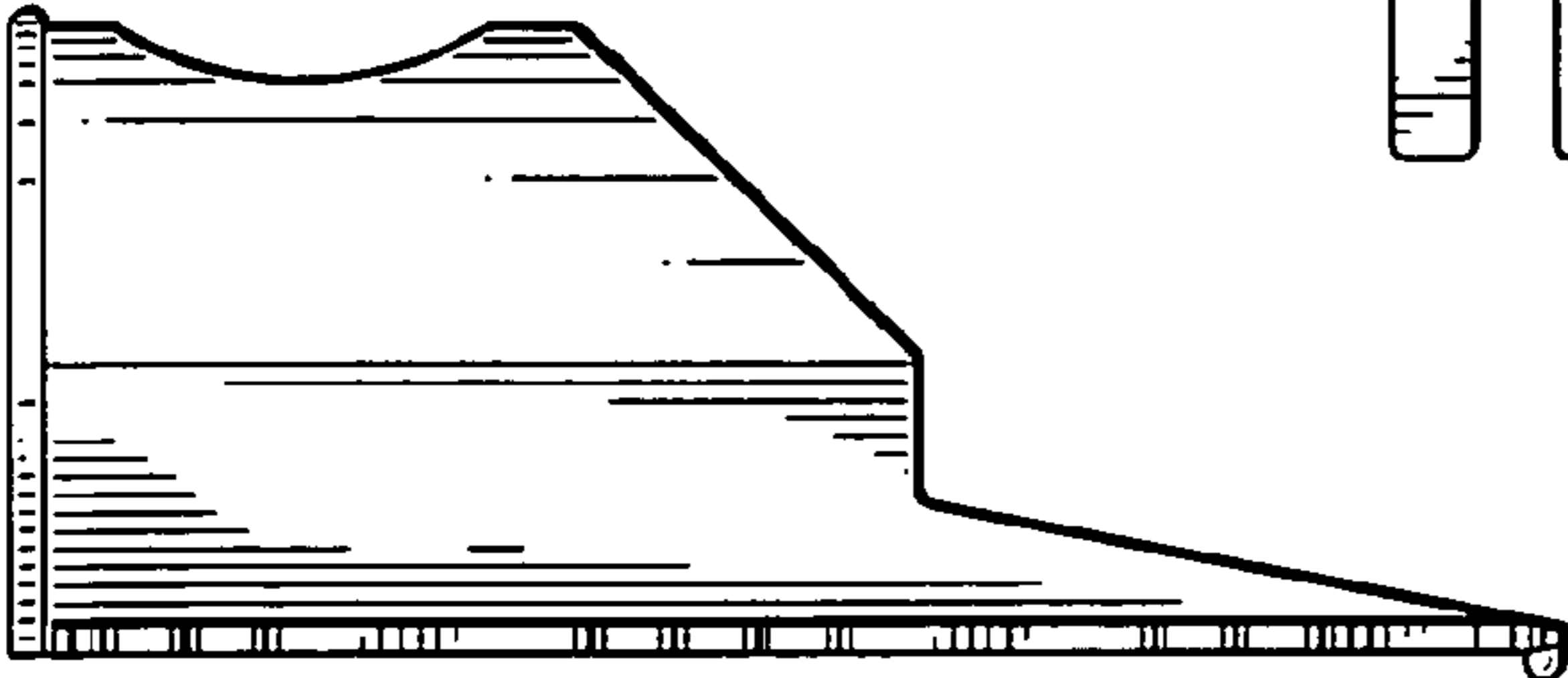
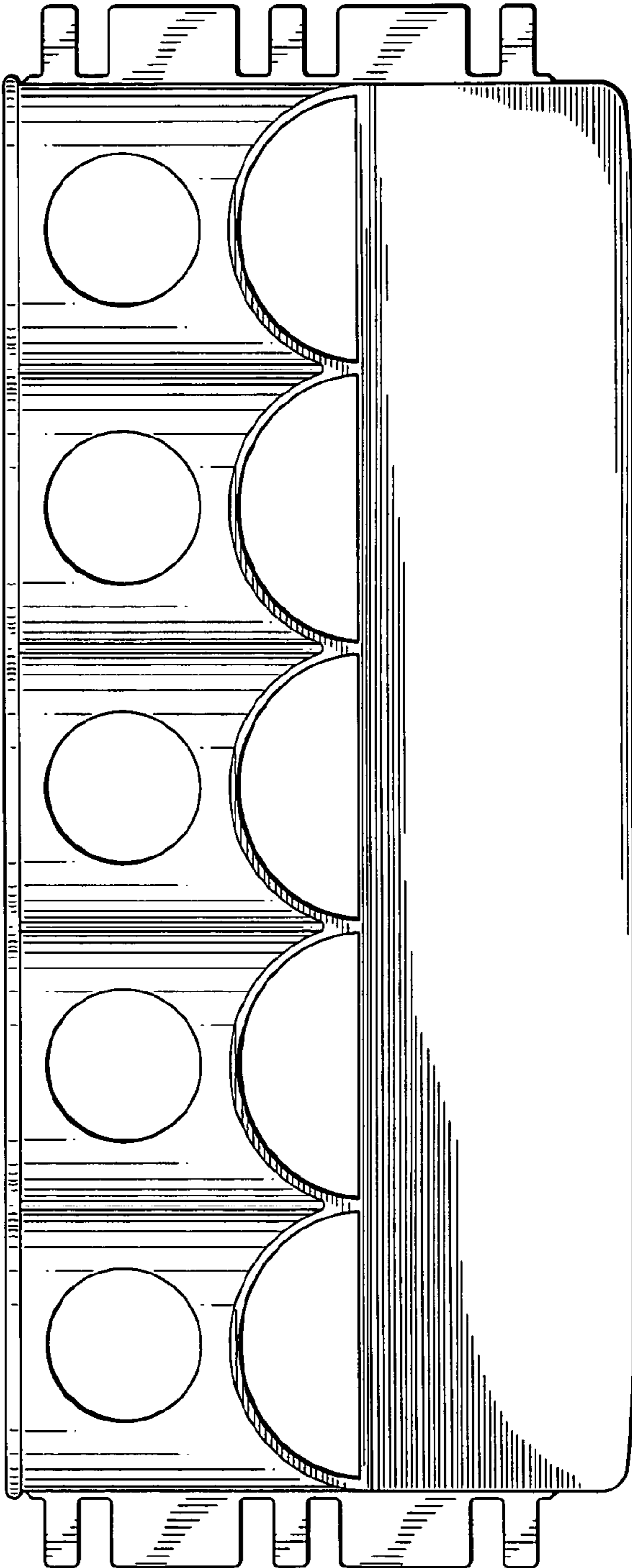

FIG. 4



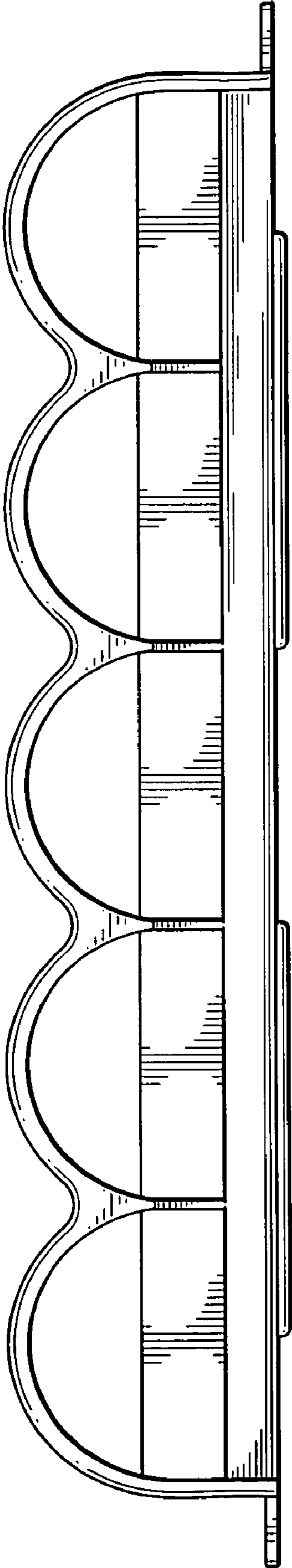

FIG. 5

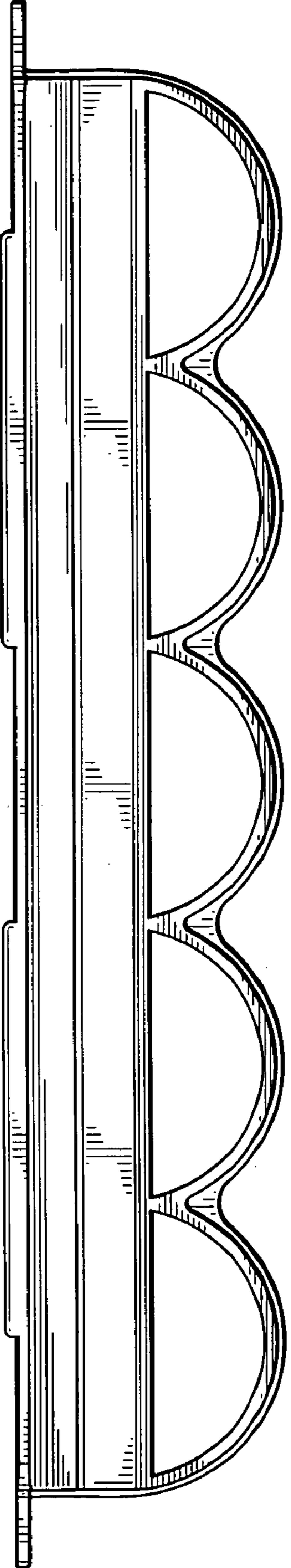

FIG. 6

UNITED STATES PATENT AND TRADEMARK OFFICE
CERTIFICATE OF CORRECTION

PATENT NO. : Des. 591,088 S
APPLICATION NO. : 29/313194
DATED : April 28, 2009
INVENTOR(S) : Paul Belokin

Page 1 of 1

It is certified that error appears in the above-identified patent and that said Letters Patent is hereby corrected as shown below:

Title page, item (73) Assignee: should read --Displays by Martin Paul, Inc. – Creative Center, Denton, TX (US)--

Signed and Sealed this

Ninth Day of June, 2009



JOHN DOLL

Acting Director of the United States Patent and Trademark Office