



US00D591048S

(12) **United States Design Patent**
Gonzalez

(10) **Patent No.:** **US D591,048 S**
(45) **Date of Patent:** **** Apr. 28, 2009**

(54) **HANDBAG**
(75) Inventor: **Alvaro Gonzalez**, Florence (IT)
(73) Assignee: **J. Choo Limited**, London (GB)
(**) Term: **14 Years**
(21) Appl. No.: **29/271,662**
(22) Filed: **Jan. 23, 2007**

D560,908 S * 2/2008 Gerbi D3/246
D569,622 S 5/2008 Gonzalez
D576,472 S * 9/2008 Gaiardo D3/246

* cited by examiner

Primary Examiner—Holly H Baynham
(74) *Attorney, Agent, or Firm*—Fross Zelnick Lehrman & Zissu, P.C.; Lawrence E. Apolzon, Esq.

(30) **Foreign Application Priority Data**
Jul. 28, 2006 (EM) 000571591-0006
(51) **LOC (9) Cl.** **03-01**
(52) **U.S. Cl.** **D3/318**
(58) **Field of Classification Search** D3/232–233,
D3/240–246, 322, 324; 150/100, 103–104,
150/107–110, 118–119
See application file for complete search history.

(57) **CLAIM**

The ornamental design for handbag, as shown and described.

DESCRIPTION

FIG. 1 is a front perspective view of the handbag shown
FIG. 2 is a front view of the handbag;
FIG. 3 is a rear view of the handbag;
FIG. 4 is a left side view of the handbag;
FIG. 5 is a right side view of the handbag;
FIG. 6 is a top view of the handbag; and,
FIG. 7 is a bottom view of the handbag.

The broken line showing of the zippers, pulls, rivets, straps, and body of bag is for illustrative purposes only and forms no part of the claimed design.

(56) **References Cited**
U.S. PATENT DOCUMENTS
D501,082 S 1/2005 Morelli
D539,534 S * 4/2007 Delafontaine D3/243
D551,863 S 10/2007 Gonzalez
D559,536 S 1/2008 Gonzalez

1 Claim, 7 Drawing Sheets

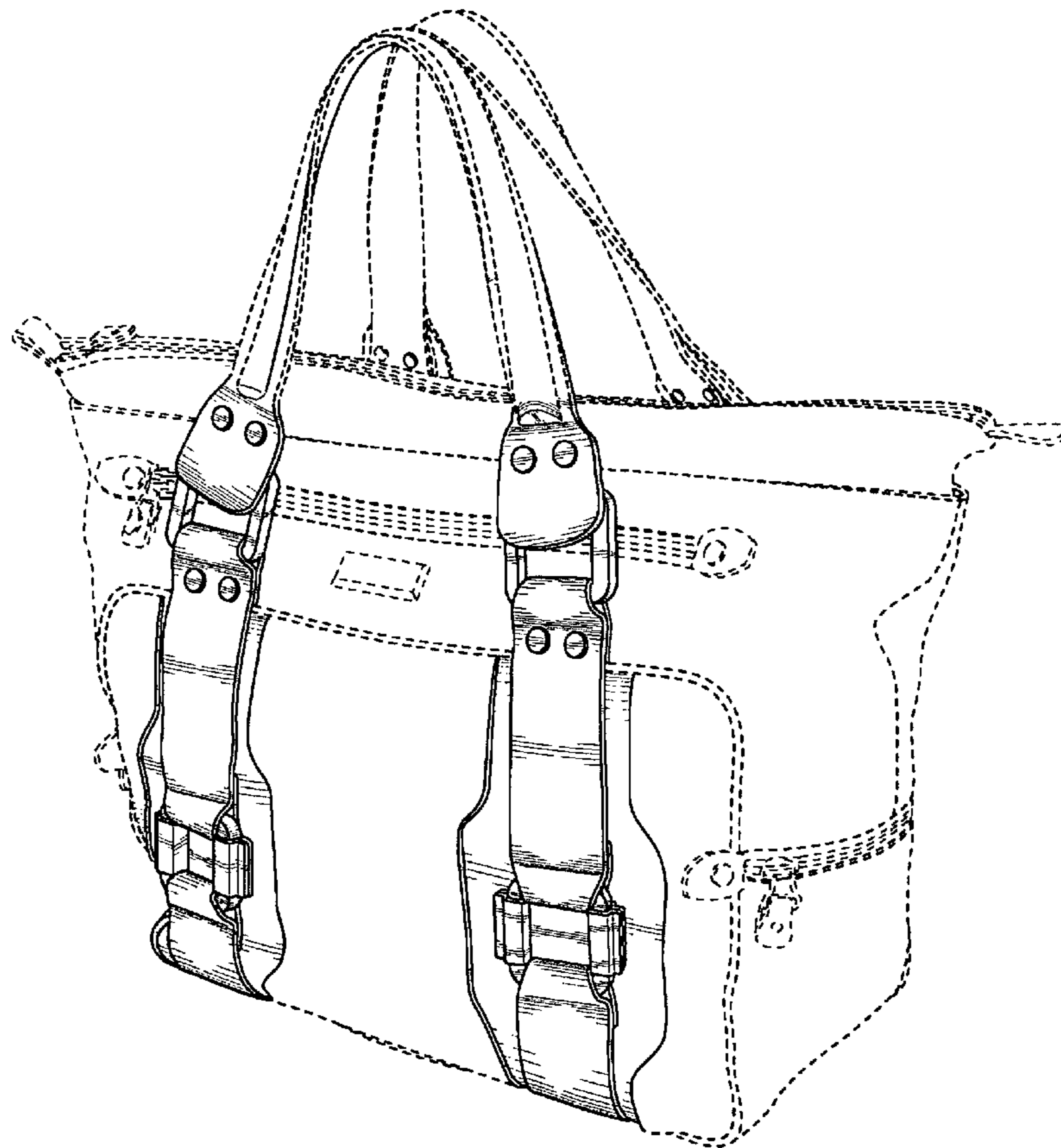

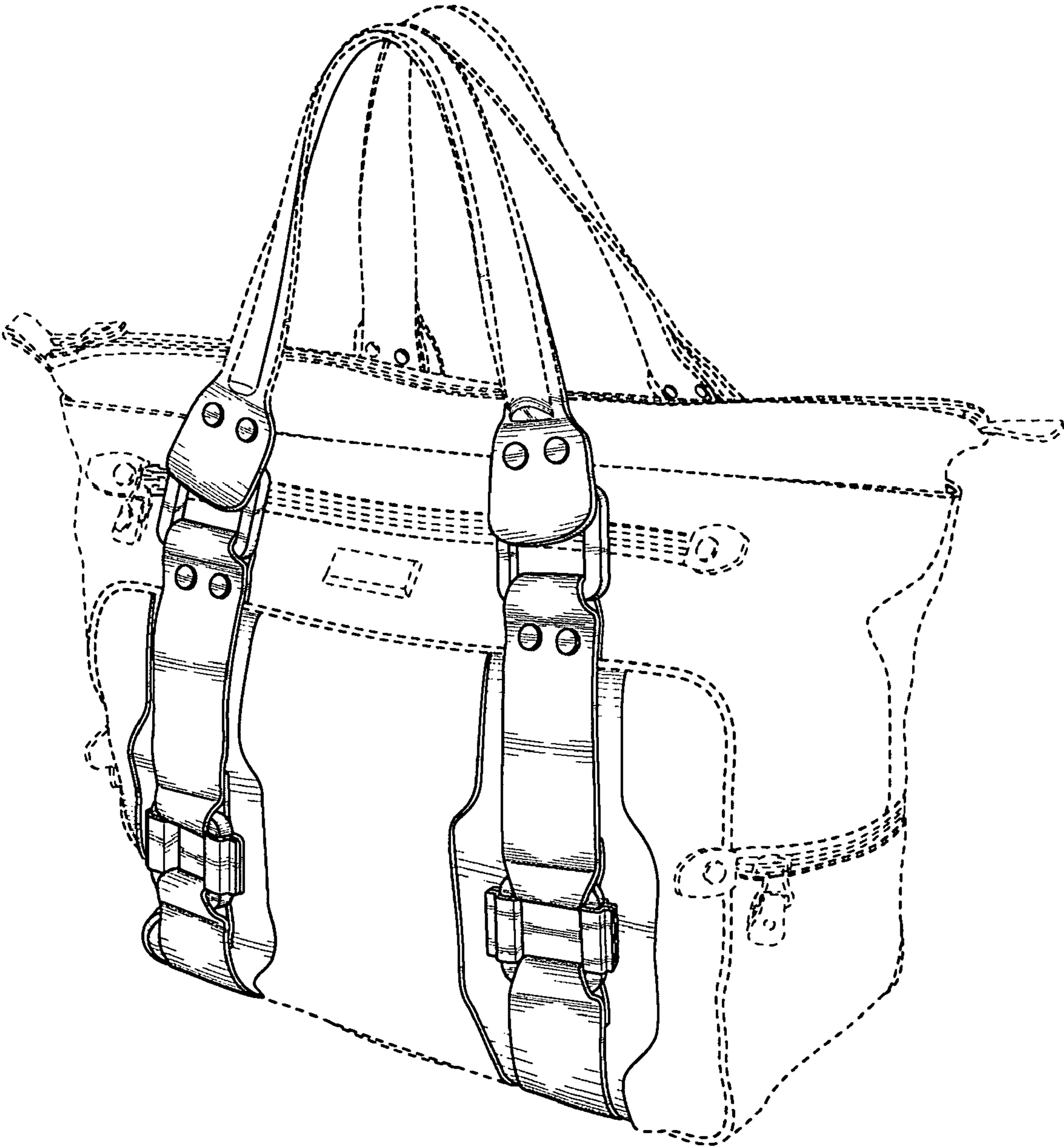

FIG. 1

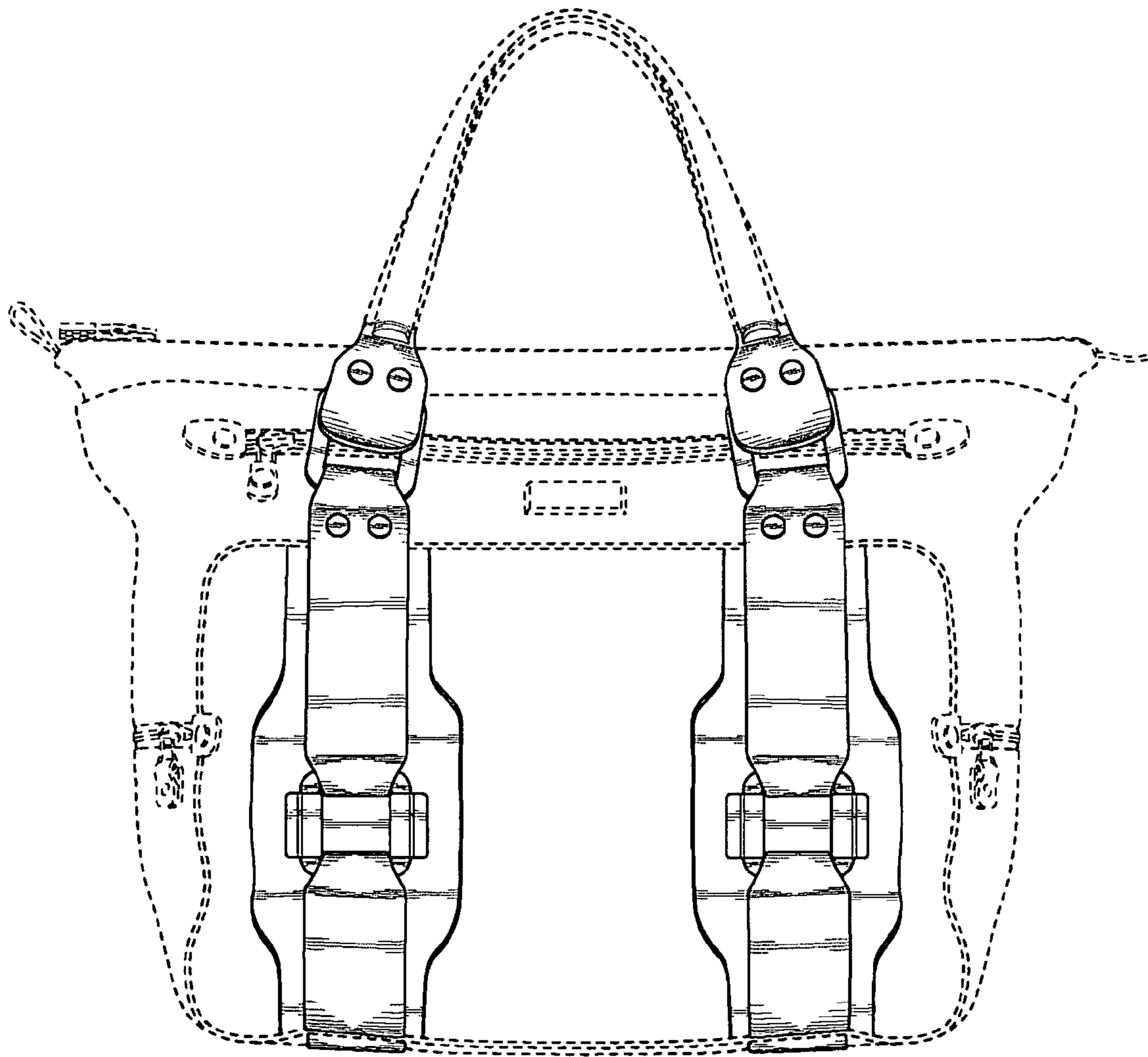

FIG. 2

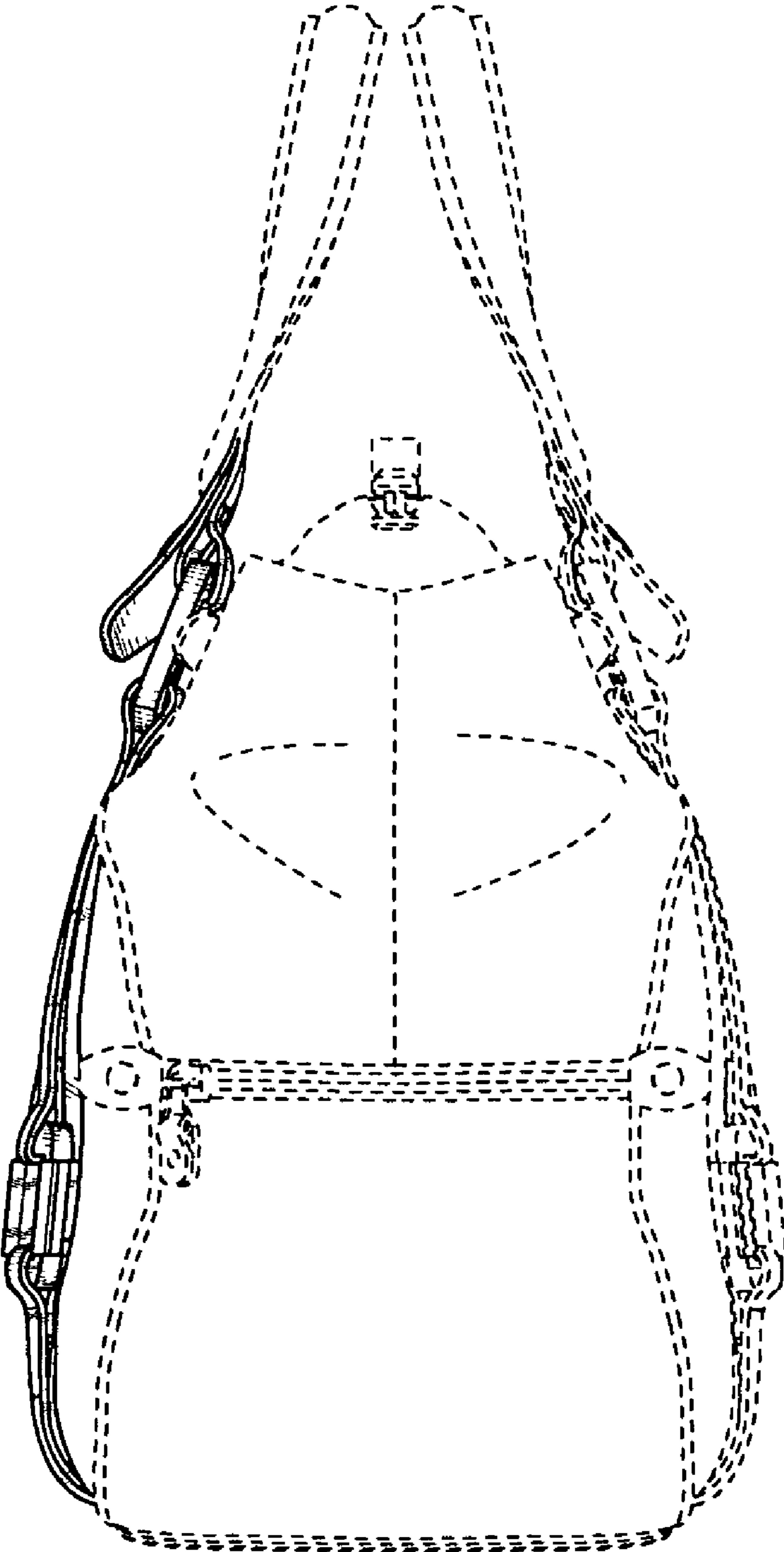

FIG. 3

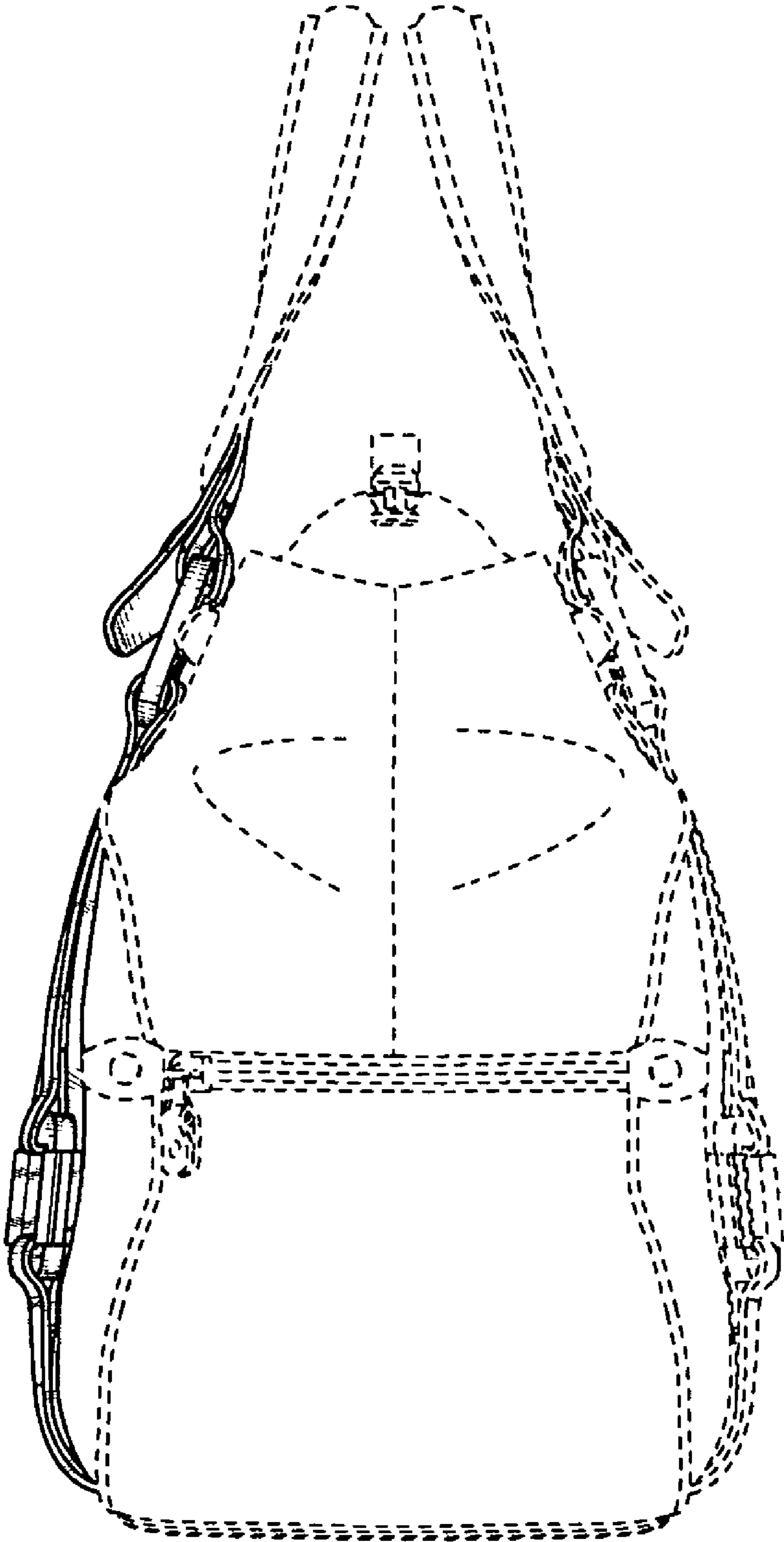

FIG. 4

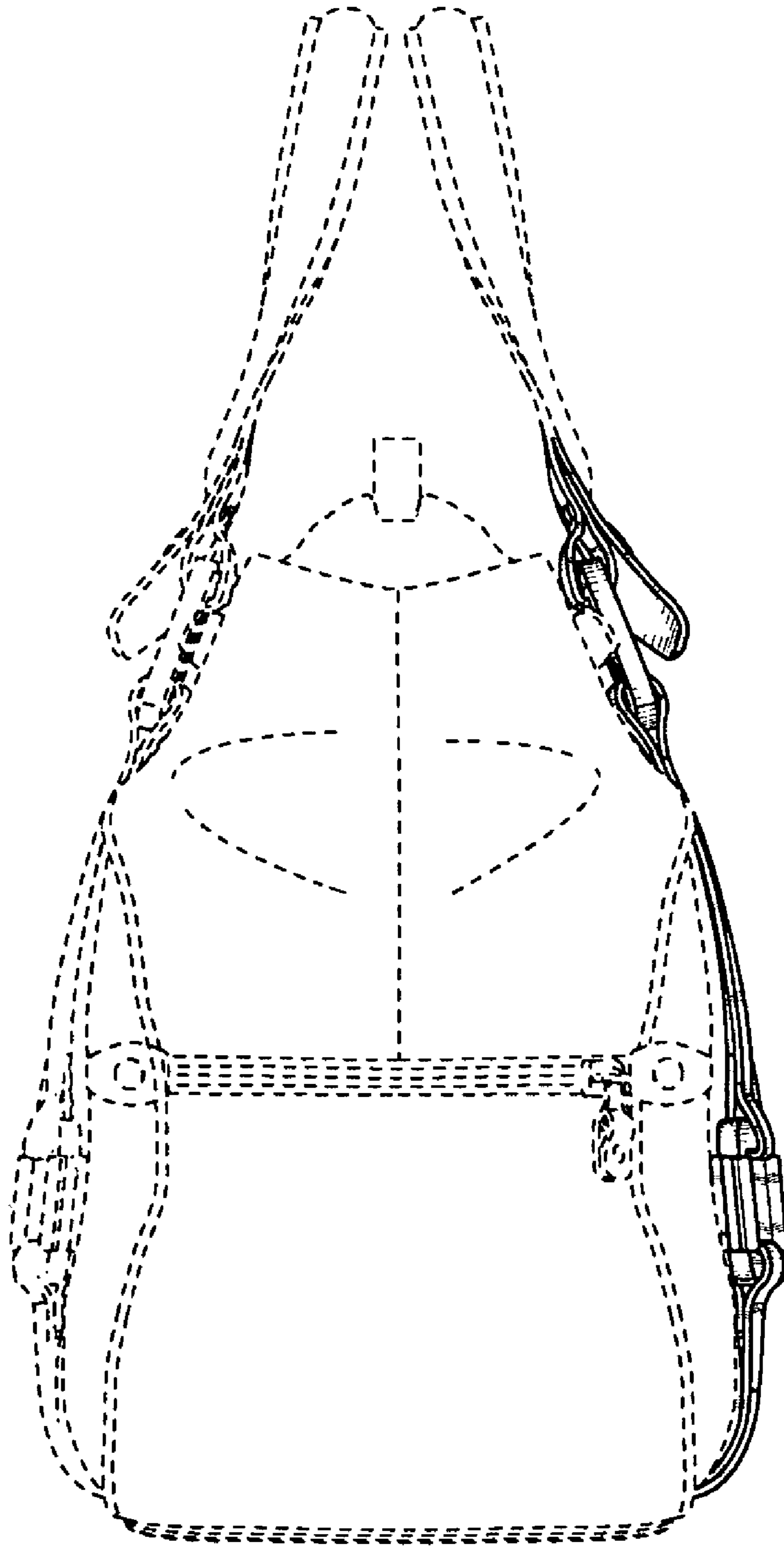

FIG. 5

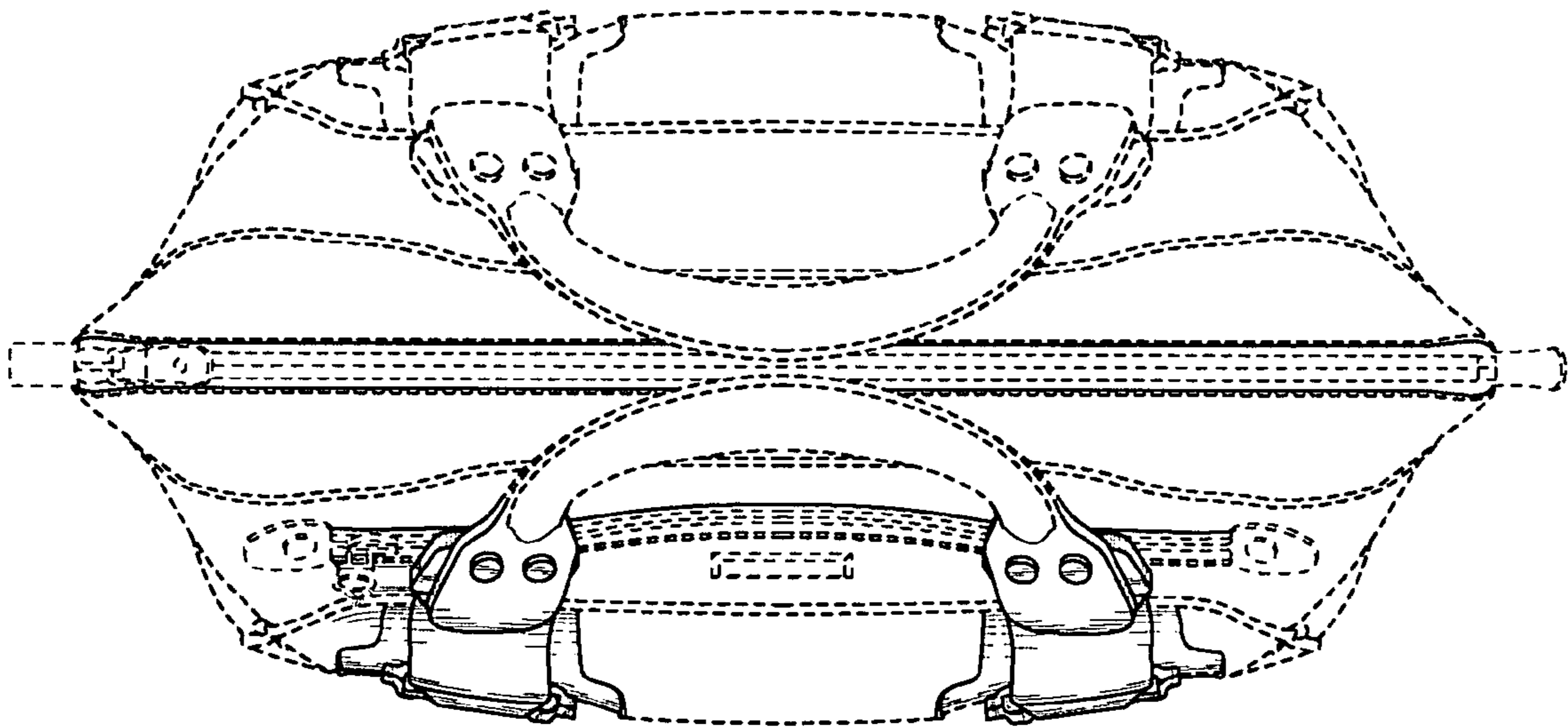

FIG. 6

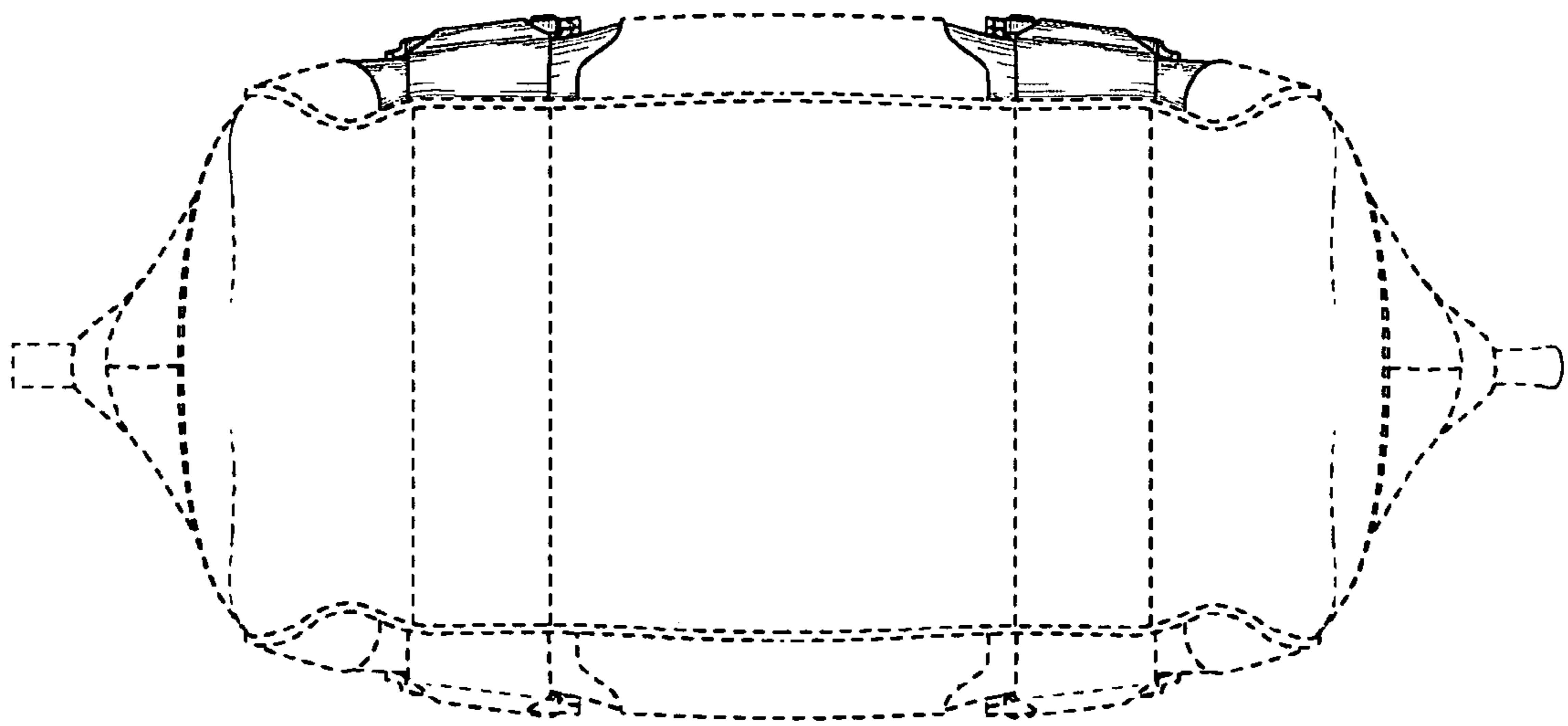

FIG. 7