



US00D591014S

(12) **United States Design Patent**  
**Li**

(10) **Patent No.:** **US D591,014 S**

(45) **Date of Patent:** **\*\* Apr. 21, 2009**

(54) **JET CLEANING MACHINE**

(76) Inventor: **Jianfang Li**, Guoxiangqiao Village,  
Lanjiang Street, Zhejiang Province,  
Yuyao (CN) 315409

(\*\*) Term: **14 Years**

(21) Appl. No.: **29/324,946**

(22) Filed: **Sep. 24, 2008**

(30) **Foreign Application Priority Data**

Mar. 26, 2008 (CN) ..... 2008 3 0113902

(51) **LOC (9) Cl.** ..... **15-05**

(52) **U.S. Cl.** ..... **D32/15**

(58) **Field of Classification Search** ..... D32/1,  
D32/15, 16, 25, 21, 22, 31; 15/320, 321,  
15/323, 332, 403, 405; D15/7; 134/201  
See application file for complete search history.

(56) **References Cited**

**U.S. PATENT DOCUMENTS**

D488,596 S *	4/2004	Cattaneo	.....	D32/15
D489,497 S *	5/2004	Cattaneo	.....	D32/15
D489,498 S *	5/2004	Cattaneo	.....	D32/15
D490,948 S *	6/2004	Cattaneo	.....	D32/15
D551,813 S *	9/2007	Renner	.....	D32/15

D551,814 S *	9/2007	Renner	.....	D32/15
D556,959 S *	12/2007	Li	.....	D32/15
D559,481 S *	1/2008	Renner	.....	D32/15
D560,046 S *	1/2008	Renner	.....	D32/15
D564,147 S *	3/2008	Li	.....	D32/15
D568,557 S *	5/2008	Alexander	.....	D32/15

\* cited by examiner

*Primary Examiner*—T. Chase Nelson

*Assistant Examiner*—Kathleen M Sims

(74) *Attorney, Agent, or Firm*—Saul Ewing LLP

(57) **CLAIM**

The ornamental design for a jet cleaning machine, as shown and described.

**DESCRIPTION**

FIG. 1 is a front elevation view of a jet cleaning machine showing my new design;

FIG. 2 is a rear elevation view thereof;

FIG. 3 is a side elevation view thereof;

FIG. 4 is an opposite side elevation view thereof;

FIG. 5 is a top plan view thereof;

FIG. 6 is a bottom plan view thereof; and,

FIG. 7 is a perspective view thereof.

**1 Claim, 7 Drawing Sheets**

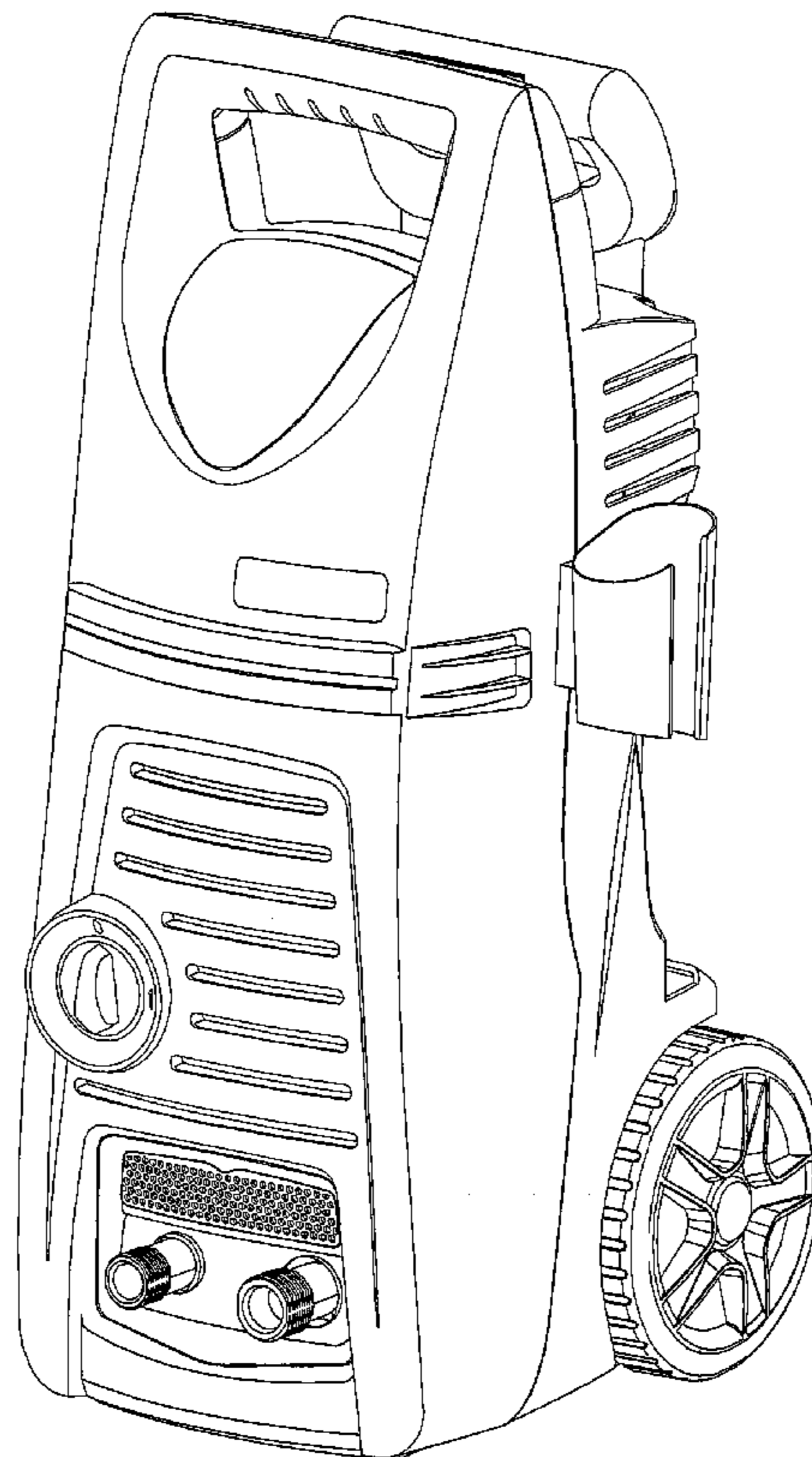

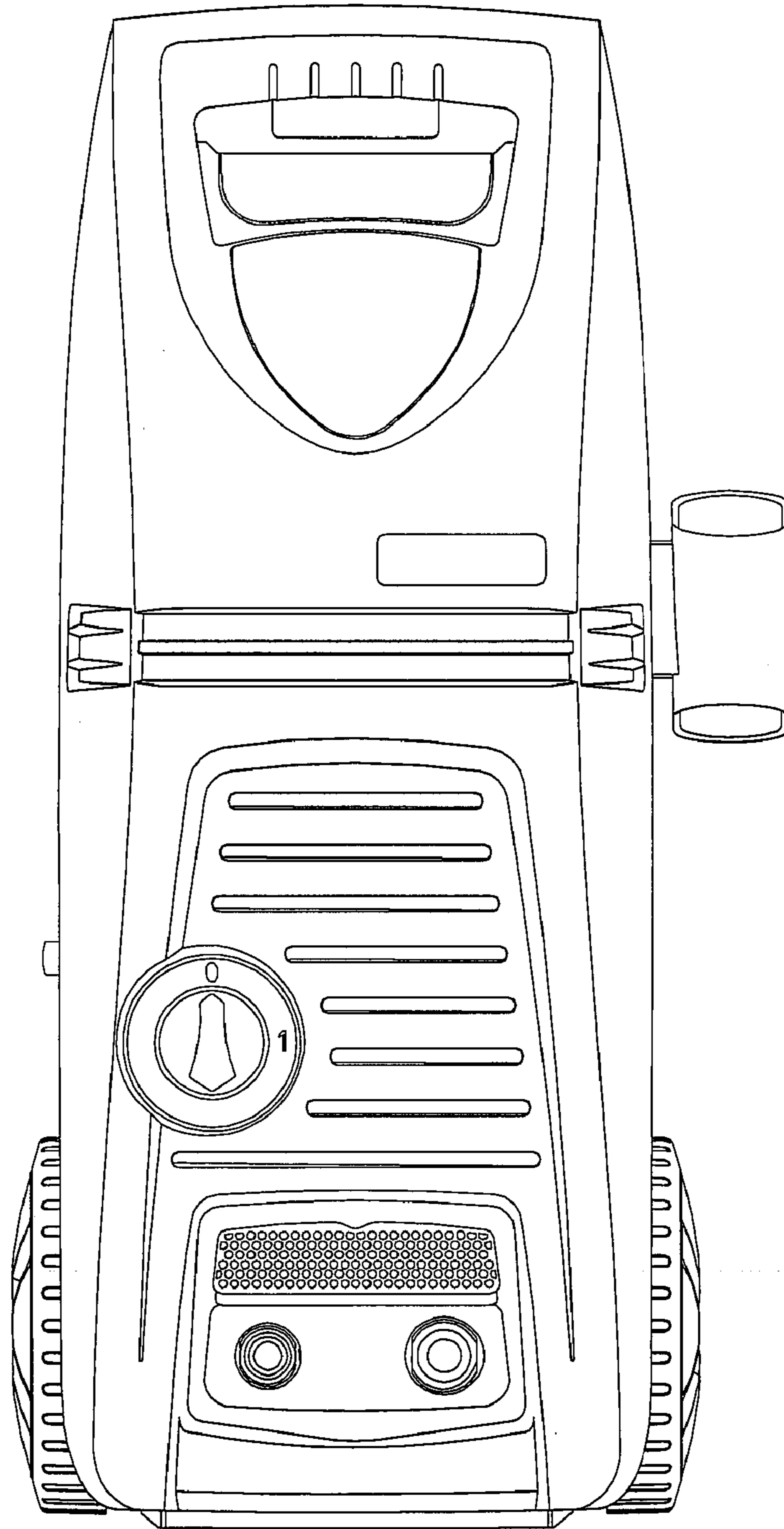

Figure 1

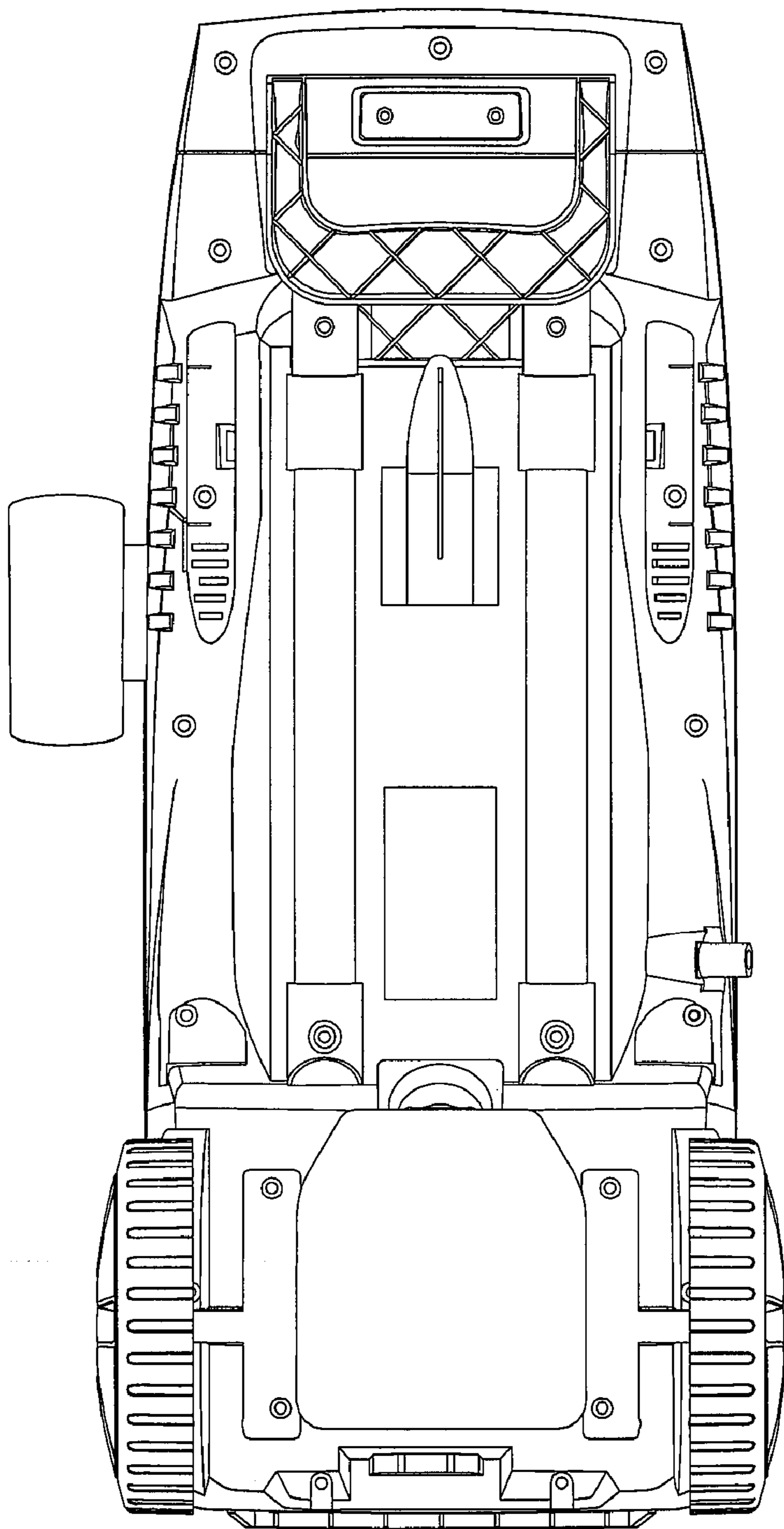

Figure 2

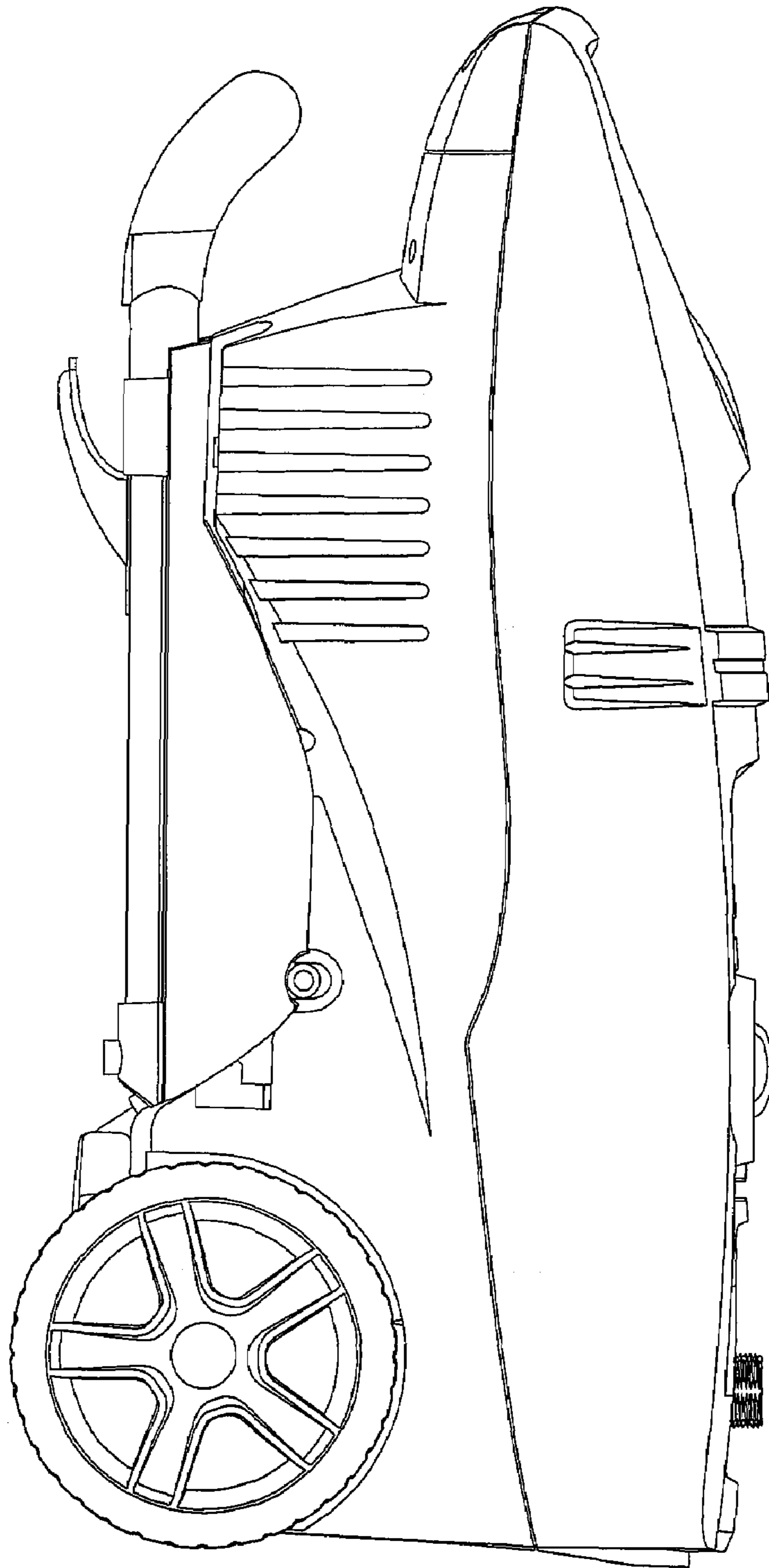

Figure 3

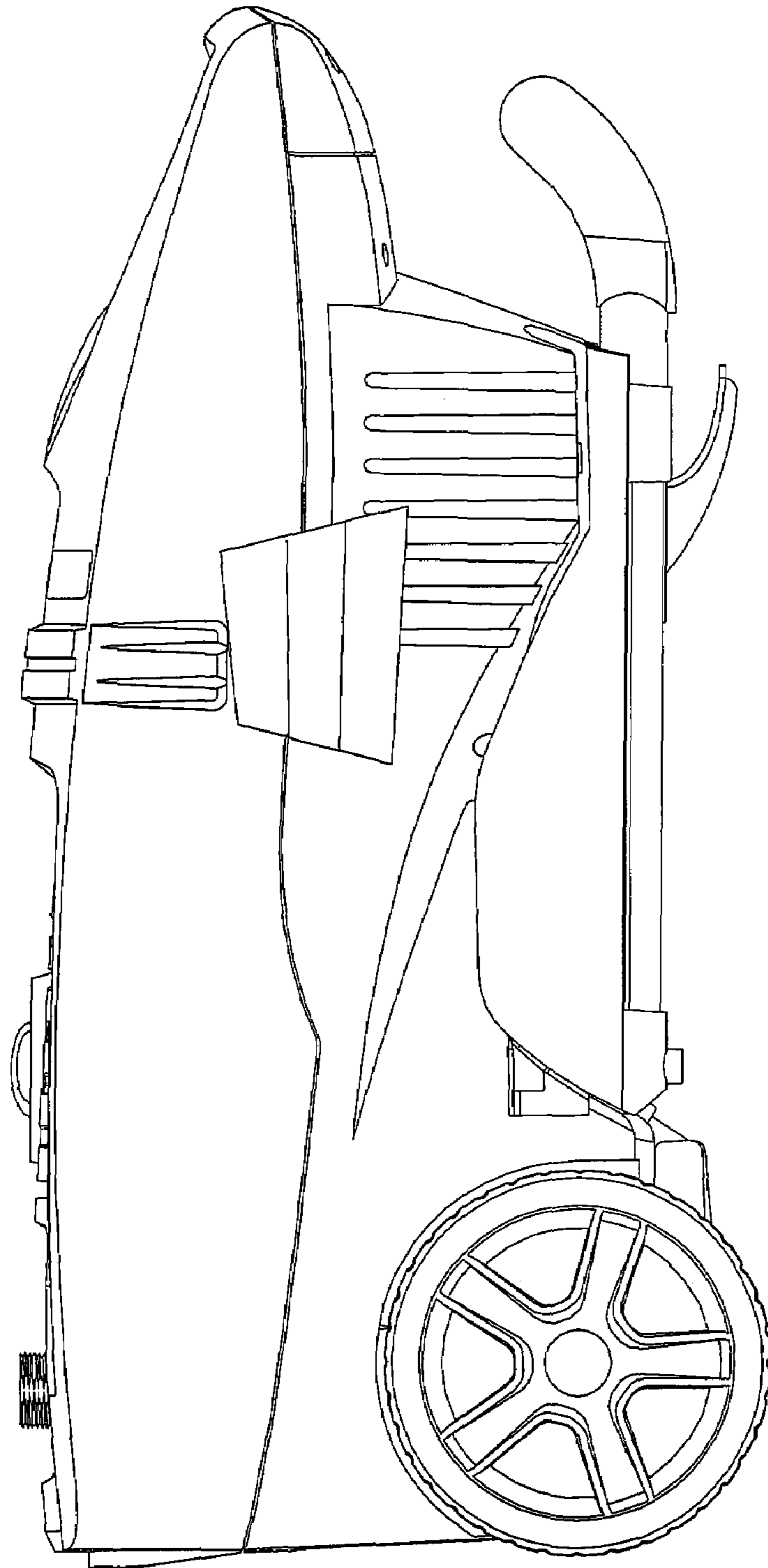

Figure 4



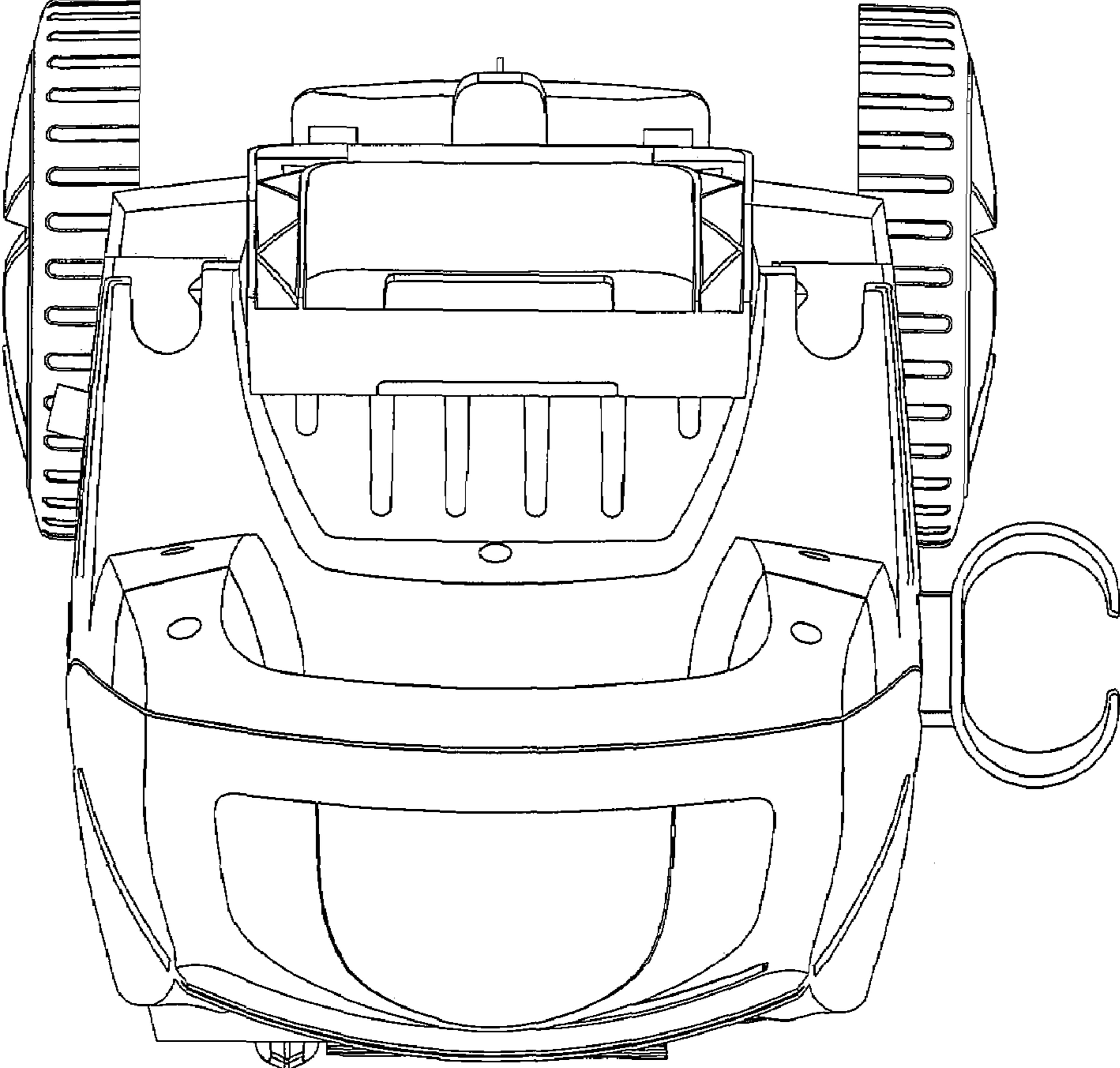

Figure 5

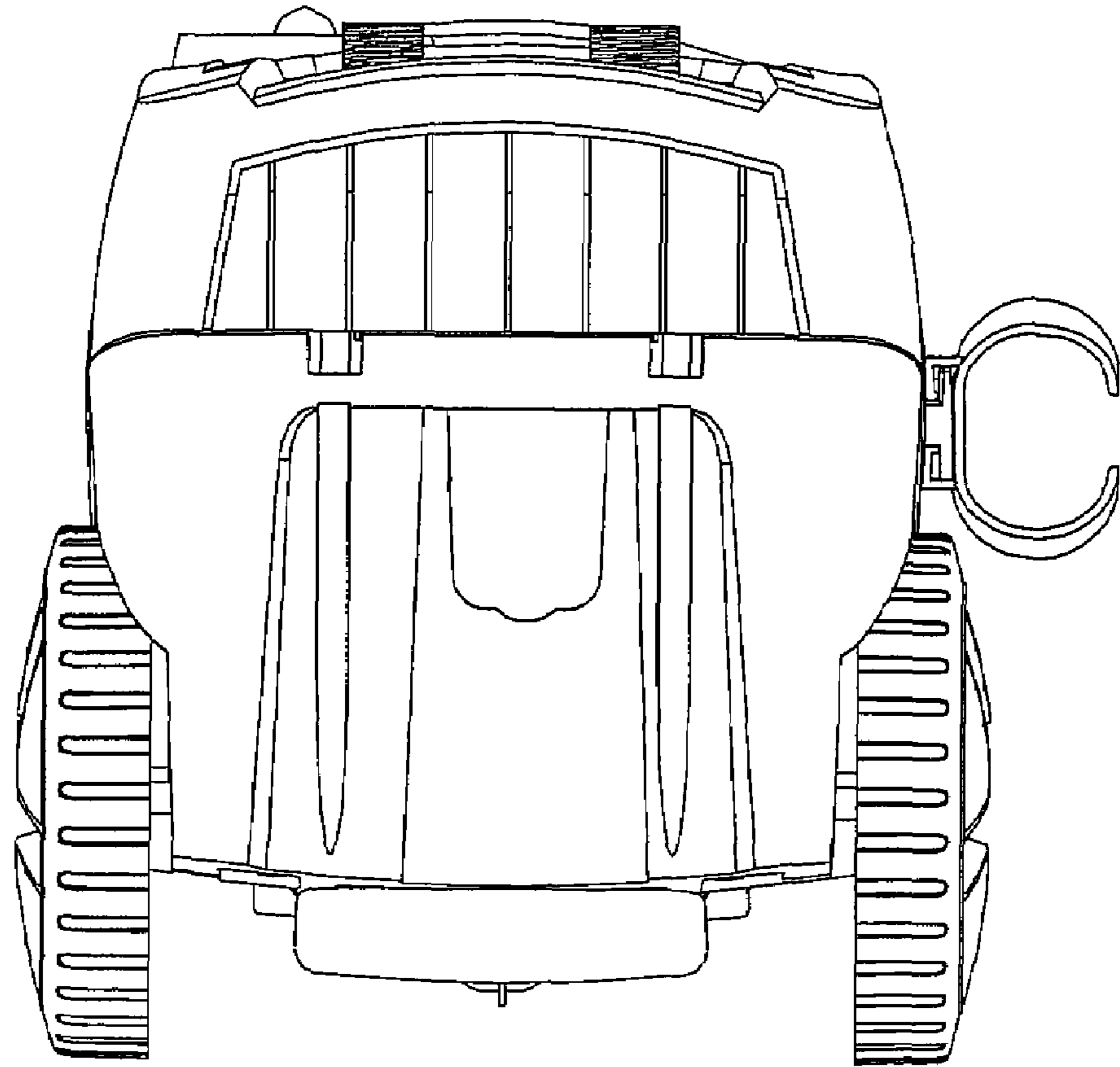

Figure 6

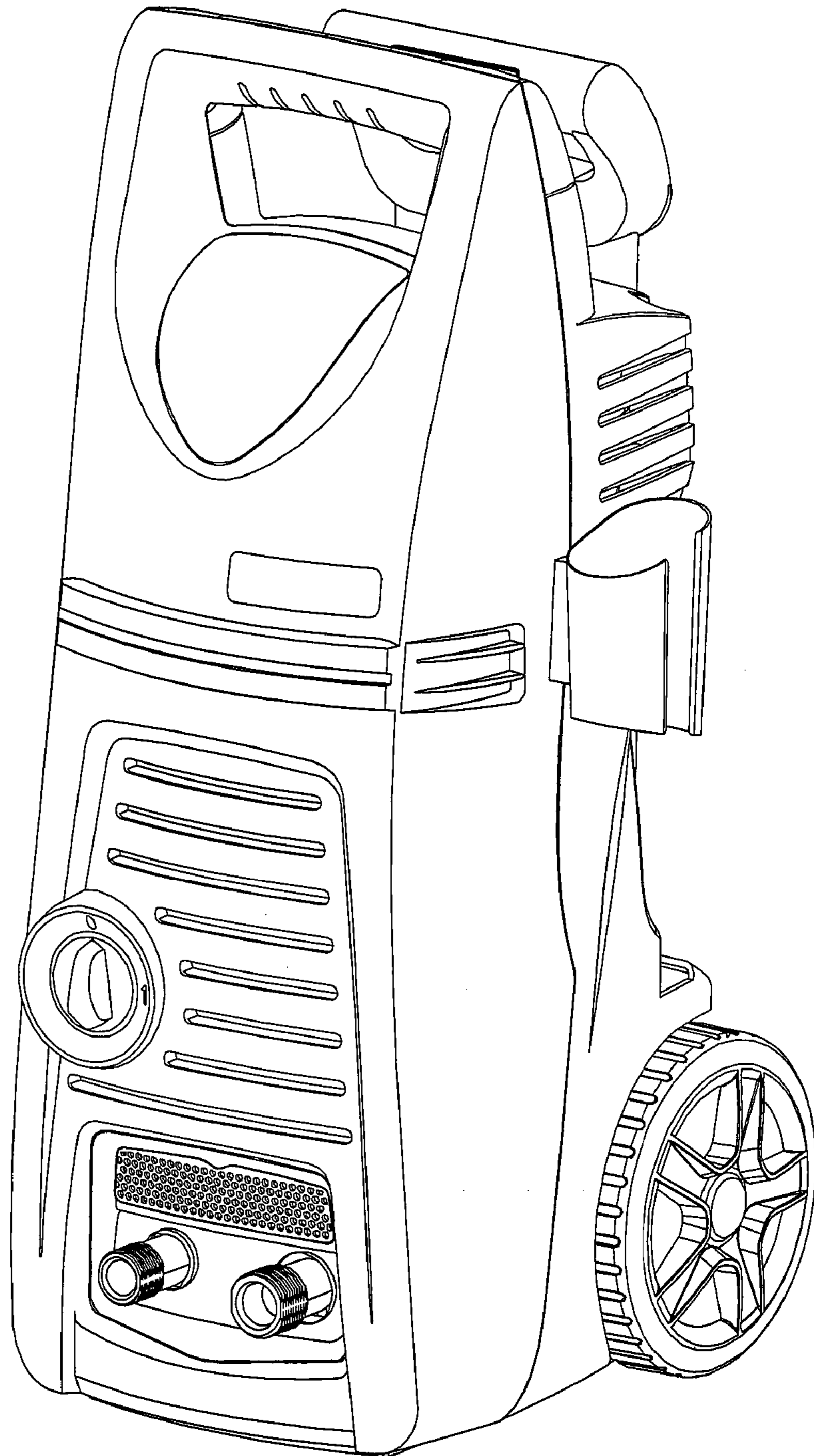

Figure 7