



US00D590796S

(12) **United States Design Patent**
Kim et al.

(10) **Patent No.:** **US D590,796 S**
(45) **Date of Patent:** **** Apr. 21, 2009**

(54) **PORTABLE PHONE**

(75) Inventors: **Young-Sae Kim**, Palo Alto, CA (US);
Ji-Eun Lee, Seoul (KR); **Young-Ju Yeo**,
Seoul (KR); **Chang-Soo Lee**, Incheon-Si
(KR)

(73) Assignee: **Samsung Electronics Co., Ltd.**,
Suwon-si (KR)

(**) Term: **14 Years**

(21) Appl. No.: **29/300,731**

(22) Filed: **Apr. 30, 2008**

(51) **LOC (9) Cl.** **14-03**

(52) **U.S. Cl.** **D14/138 AD**

(58) **Field of Classification Search** D14/137,
D14/138 R, 138 AA, 138 AB, 138 AC, 138 AD,
D14/138 C, 138 G, 147, 191, 218, 247-248,
D14/341-347, 455, 496; D10/65, 78, 104;
D13/168; D18/7; 455/556.1, 566, 575.1,
455/575.3; 345/169

See application file for complete search history.

(56) **References Cited**

U.S. PATENT DOCUMENTS

D495,695	S	*	9/2004	Yugaya	D14/346
D496,645	S	*	9/2004	Yoo et al.	D14/138 G
D528,094	S	*	9/2006	Hwang	D14/138 AD
D531,609	S	*	11/2006	Kim et al.	D14/138 AB
D534,516	S	*	1/2007	Lheem	D14/138 AD
D535,631	S	*	1/2007	Millora	D14/126
D544,460	S	*	6/2007	Yau	D14/138 AD
D547,331	S	*	7/2007	Jung et al.	D14/496
D549,204	S	*	8/2007	Cho	D14/138 AD
D551,201	S	*	9/2007	Kim et al.	D14/138 AD
D551,646	S	*	9/2007	Kim et al.	D14/138 AC
D551,647	S	*	9/2007	Kim et al.	D14/138 AD
7,269,450	B2	*	9/2007	Lee et al.	455/575.1
D555,616	S	*	11/2007	Lin	D14/138 AD
D556,726	S	*	12/2007	Dai	D14/138 AA
D561,155	S	*	2/2008	Kim et al.	D14/138 AD

D562,793	S	*	2/2008	Kim et al.	D14/138 AD
D563,938	S	*	3/2008	Kim et al.	D14/138 AD
D566,110	S	*	4/2008	Park et al.	D14/247
D576,141	S	*	9/2008	Moon et al.	D14/138 G
D579,439	S	*	10/2008	Chung et al.	D14/138 R
D579,904	S	*	11/2008	Kim et al.	D14/138 R
D580,390	S	*	11/2008	Kim et al.	D14/138 R
D580,397	S	*	11/2008	Seo et al.	D14/138 R
2006/0052145	A1	*	3/2006	Go	455/575.1
2007/0080950	A1	*	4/2007	Lee et al.	345/169

OTHER PUBLICATIONS

Eten glogfish X500, announced Oct. 2006, [online], [retrieved on Feb. 20, 2007]. Retrieved from Internet ,<URL: <http://www.gsmarena.com>>.*

(Continued)

Primary Examiner—Jeffrey D Asch

Assistant Examiner—Bridget L Eland

(74) *Attorney, Agent, or Firm*—Staas & Halsey LLP

(57) **CLAIM**

The ornamental design for a portable phone, as shown and described.

DESCRIPTION

FIG. 1 is a perspective view of a portable phone;
FIG. 2 is a front view of the portable phone of FIG. 1;
FIG. 3 is a rear view of the portable phone of FIG. 1;
FIG. 4 is a left-side view of the portable phone of FIG. 1;
FIG. 5 is a right-side view of the portable phone of FIG. 1;
FIG. 6 is a top plan view of the portable phone of FIG. 1;
FIG. 7 is a bottom plan view of the portable phone of FIG. 1;
FIG. 8 is a front open view of the portable phone of FIG. 1;
FIG. 9 is a right-side open view of the portable phone of FIG. 1; and,
FIG. 10 is a right-side open perspective view of the portable phone of FIG. 1.

1 Claim, 7 Drawing Sheets

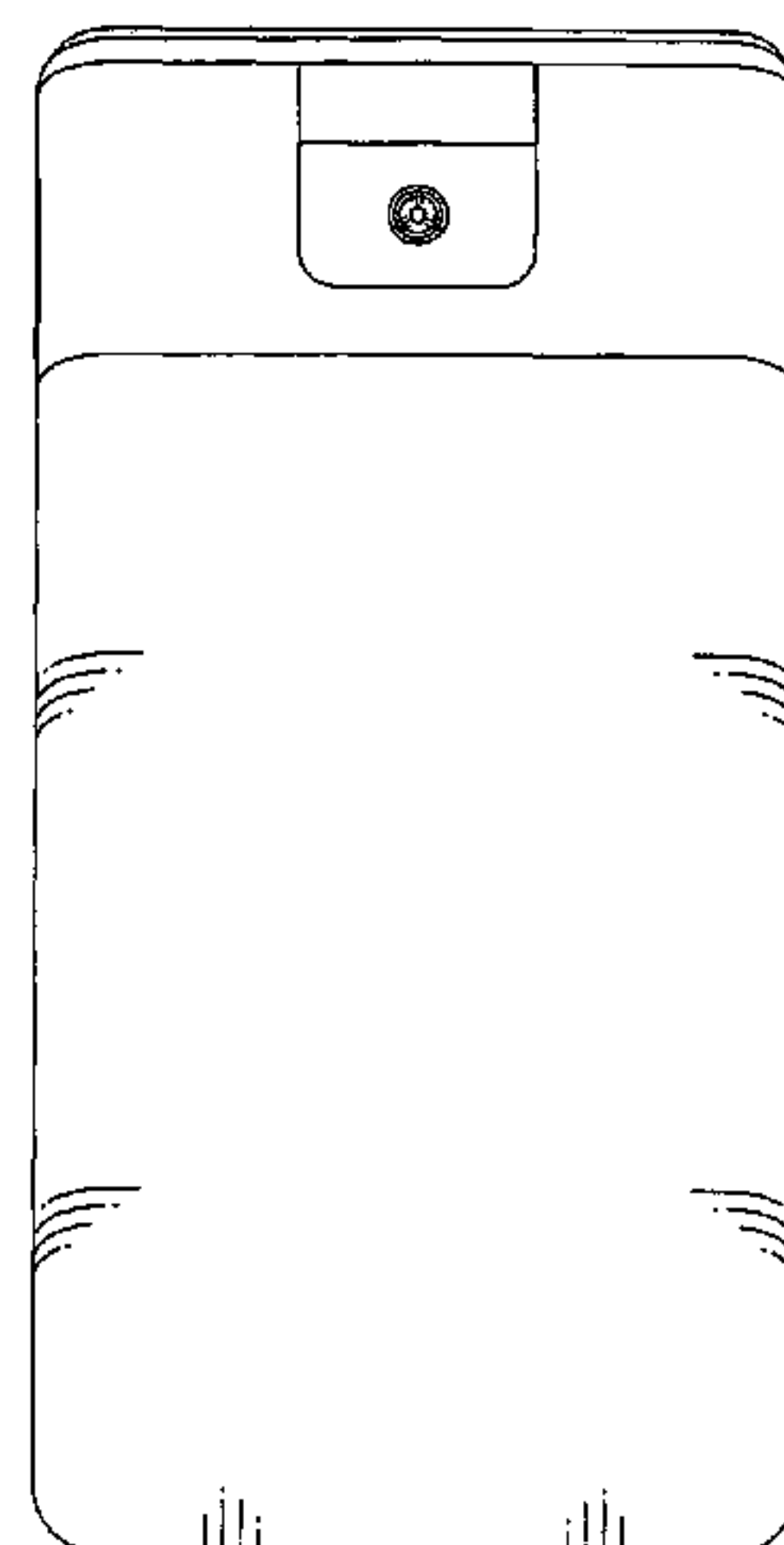
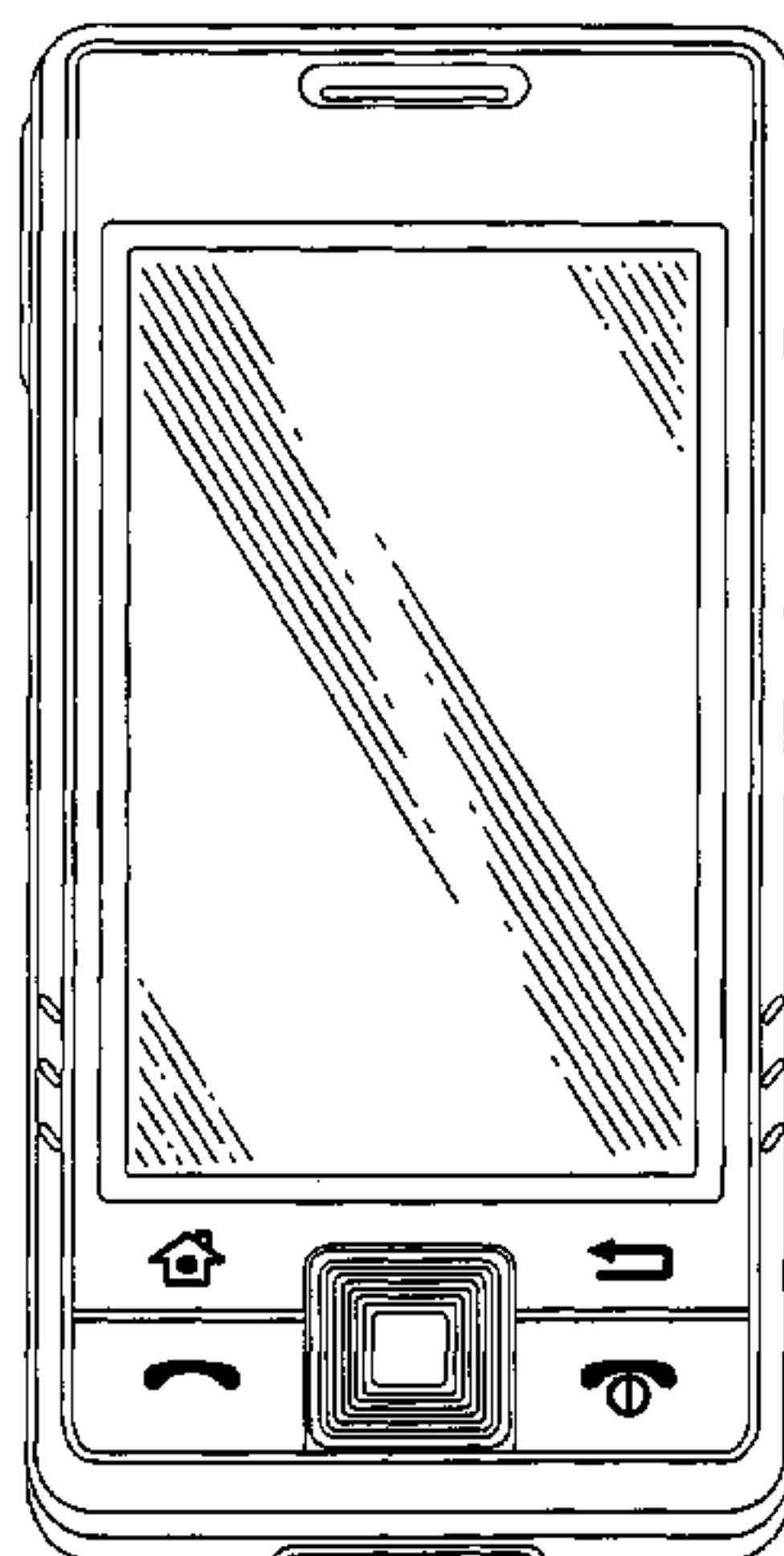

OTHER PUBLICATIONS

Gigabyte g-Smart i (128), announced 2005, [online], [retrieved on Feb. 20, 2007]. Retrieved from Internet ,<URL: <http://www.gsmarena.com>>.*

LG KC550, announced May 2008, [online], [retrieved on May 30, 2008]. Retrieved from Internet ,<URL: <http://www.gsmarena.com>>.*

Samsung F110, announced Mar. 2008, [online], [retrieved on Mar. 21, 2008]. Retrieved from Internet ,<URL: <http://www.gsmarena.com>>.*

Sony Ericsson C905, announced Jun. 2008, [online], [retrieved on Jun. 27, 2008]. Retrieved from Internet ,<URL: <http://www.gsmarena.com>>.*

* cited by examiner

FIG. 1

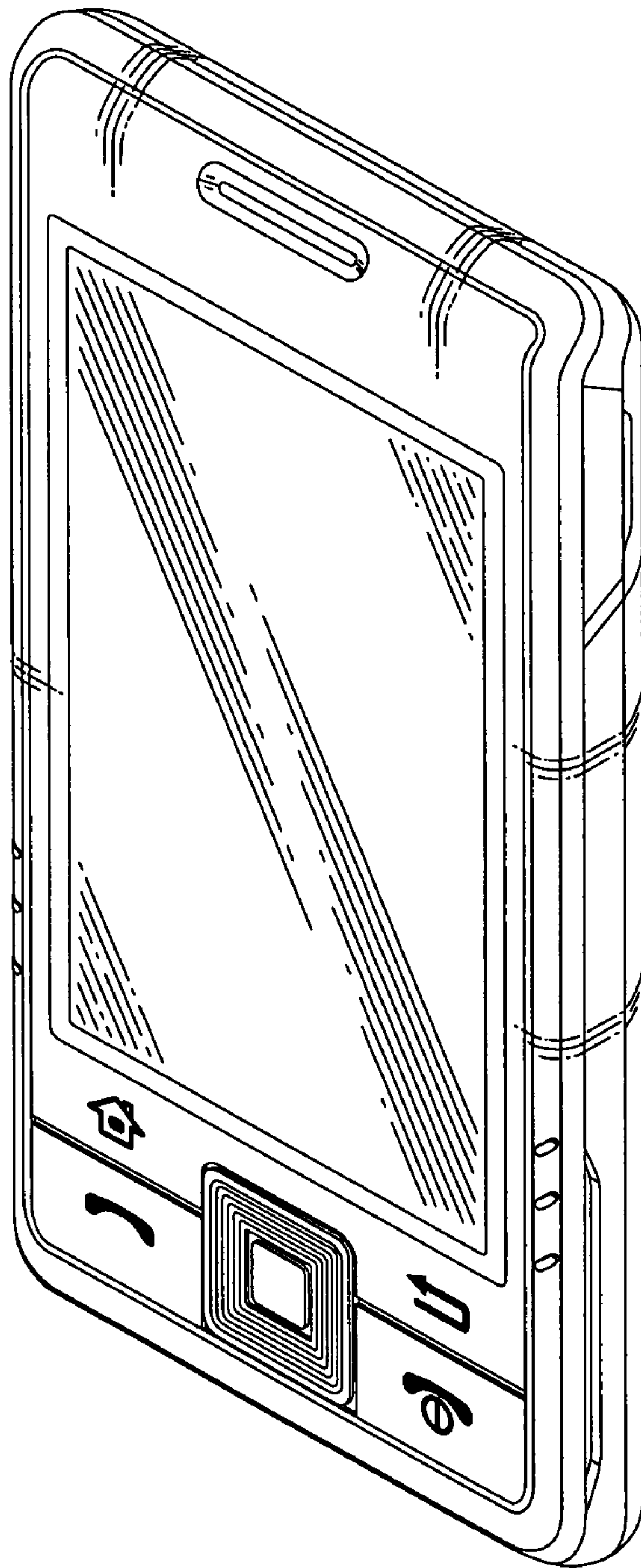

FIG. 2

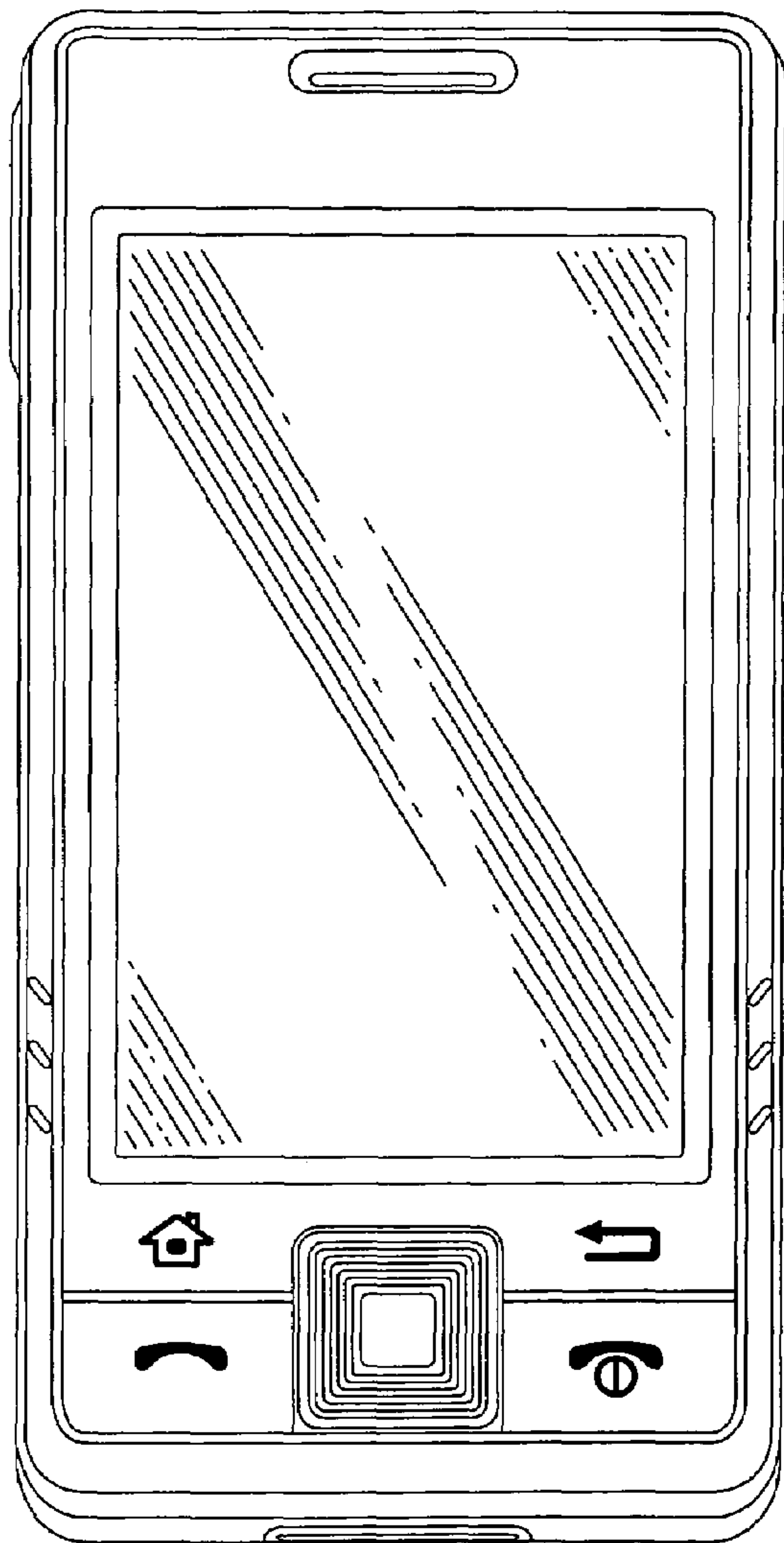

FIG. 3

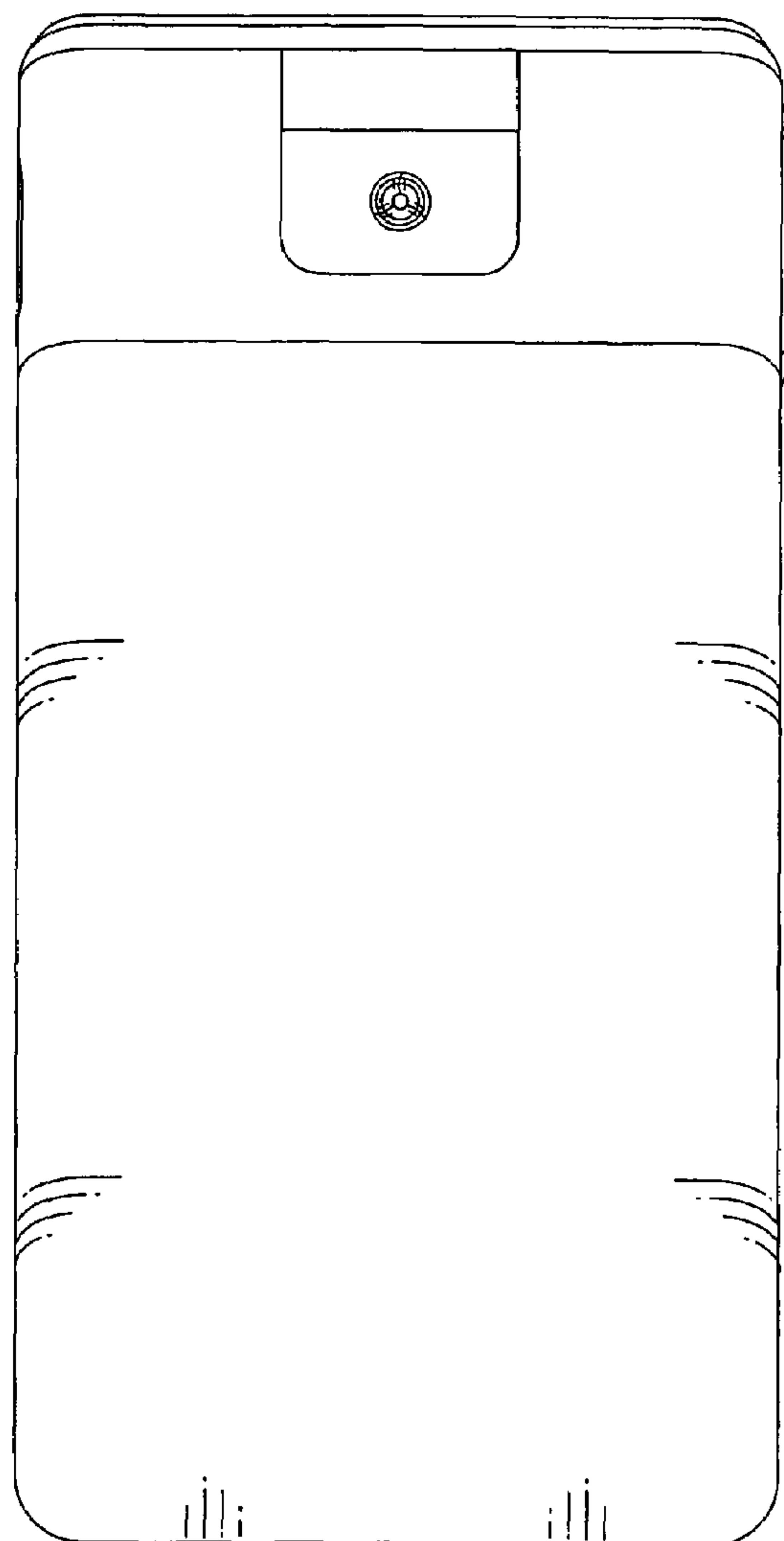

FIG. 4

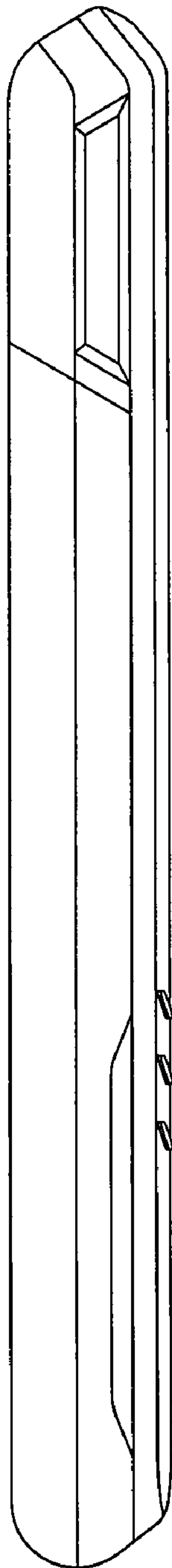

FIG. 5

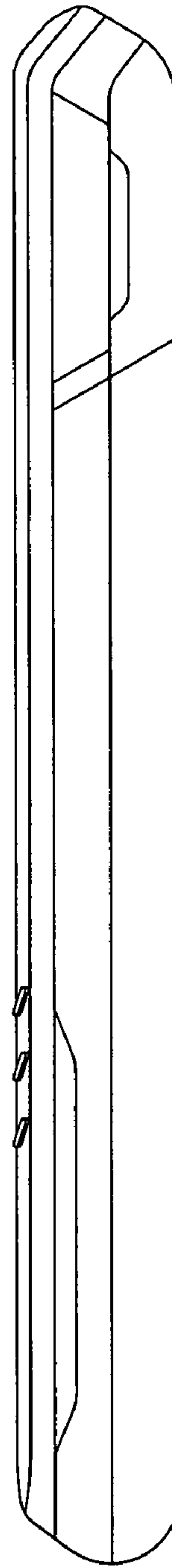

FIG. 6

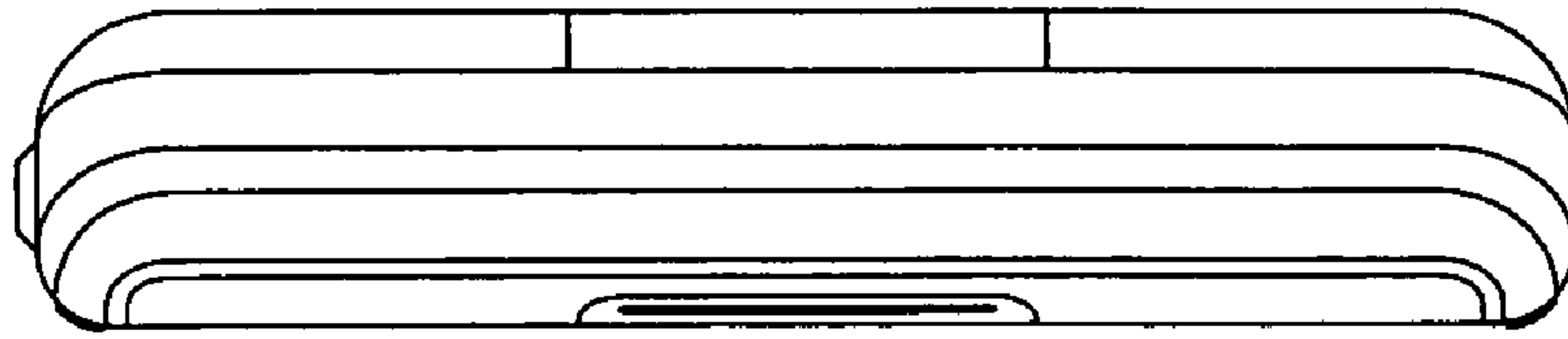

FIG. 7

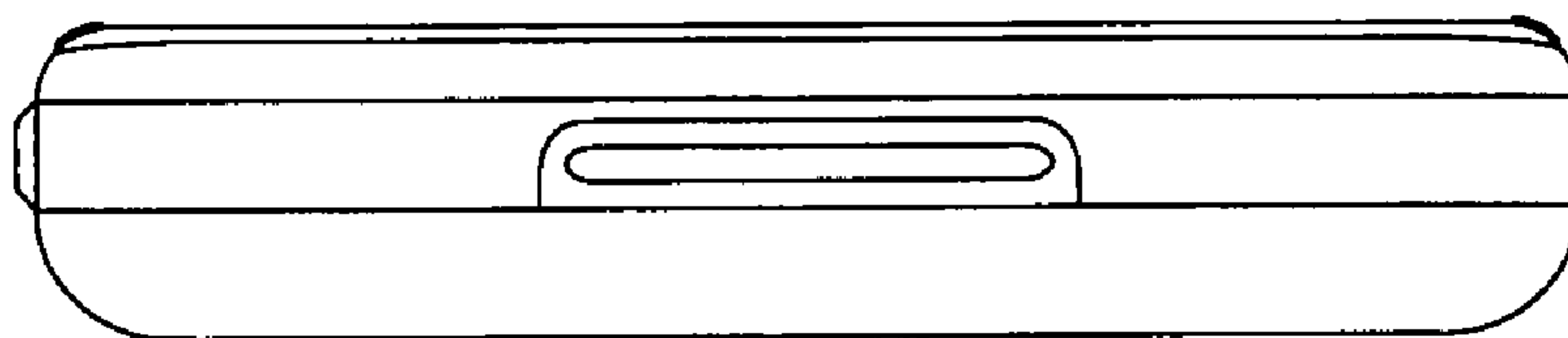

FIG. 8

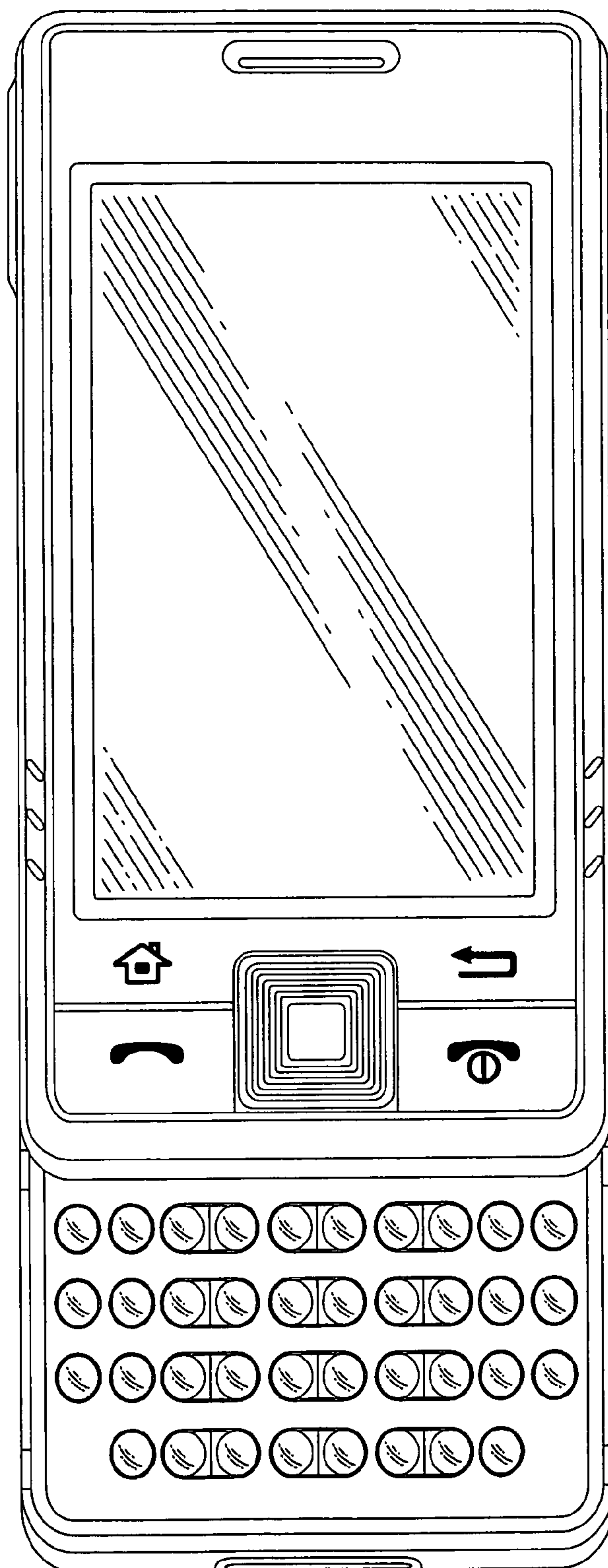

FIG. 9

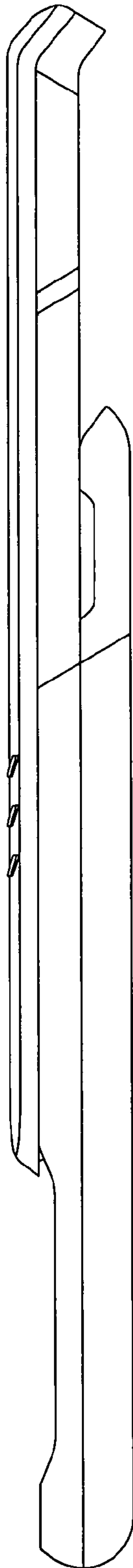

FIG. 10

