

US00D590794S

(12) **United States Design Patent**
Jeung et al.

(10) **Patent No.:** **US D590,794 S**
(45) **Date of Patent:** **** Apr. 21, 2009**

(54) **MOBILE PHONE**

(75) Inventors: **Jong-Yun Jeung**, Bucheon-si (KR);
Nam-Mi Kim, Seoul (KR)

(73) Assignee: **Samsung Electronics Co., Ltd.**,
Suwon-Si (KR)

(**) Term: **14 Years**

(21) Appl. No.: **29/290,839**

(22) Filed: **Jan. 18, 2008**

(30) **Foreign Application Priority Data**

Aug. 27, 2007 (KR) 30-2007-0036442

(51) **LOC (9) Cl.** **14-03**

(52) **U.S. Cl.** **D14/138 AD**

(58) **Field of Classification Search** D14/137,
D14/138, 147, 191, 218, 247-248, 341-347,
D14/496; D10/65, 78, 104; D13/168; D18/7;
455/556.1, 566, 575.1, 575.3; 345/169

See application file for complete search history.

(56) **References Cited**

U.S. PATENT DOCUMENTS

D525,225 S *	7/2006	Lee	D14/138
D525,227 S *	7/2006	Jang	D14/138
D534,144 S *	12/2006	Chung et al.	D14/138
D534,518 S *	1/2007	Choi et al.	D14/138
D540,204 S *	4/2007	Aguilar	D10/65
D546,345 S *	7/2007	Kim et al.	D14/496
D549,203 S *	8/2007	Kim et al.	D14/138
D555,619 S *	11/2007	Hong et al.	D14/138
D555,620 S *	11/2007	Lee et al.	D14/138
D555,623 S *	11/2007	Cho et al.	D14/138
D558,177 S *	12/2007	Han et al.	D14/138
D558,714 S *	1/2008	Kim et al.	D14/138
D559,221 S *	1/2008	Lee et al.	D14/138
D560,195 S *	1/2008	Moon et al.	D14/138
D562,290 S *	2/2008	Cho et al.	D14/138
D562,291 S *	2/2008	Bang et al.	D14/138
D563,363 S *	3/2008	Park et al.	D14/138
D567,208 S *	4/2008	Suk et al.	D14/138

D567,794 S *	4/2008	Kim et al.	D14/138
D569,834 S *	5/2008	Suk et al.	D14/138
D569,835 S *	5/2008	Han et al.	D14/138
2004/0245342 A1 *	12/2004	Cho et al.	235/472.01
2004/0246371 A1 *	12/2004	Cho et al.	348/375
2005/0124394 A1 *	6/2005	Kim et al.	455/575.3
2007/0071232 A1 *	3/2007	Chung	379/433.07
2007/0121279 A1 *	5/2007	Robertson et al.	361/679

OTHER PUBLICATIONS

HTC P3300, announced Sep. 2006, [online], [retrieved on Feb. 20, 2007]. Retrieved from Internet ,<URL: http://www.gsmarena.com>.*

LG KE500, announced Jul. 2007, [online], [retrieved on Sep. 15, 2007]. Retrieved from Internet ,<URL: http://www.gsmarena.com>.*

Samsung U600, announced Feb. 2007, [online], [retrieved on Feb. 16, 2007]. Retrieved from Internet ,<URL: http://www.gsmarena.com>.*

* cited by examiner

Primary Examiner—Jeffrey D Asch

Assistant Examiner—Bridget L Eland

(74) *Attorney, Agent, or Firm*—Staas & Halsey LLP

(57) **CLAIM**

The ornamental design for a mobile phone, as shown and described.

DESCRIPTION

FIG. 1 is a perspective view of a mobile phone;
FIG. 2 is a front view of the mobile phone of FIG. 1;
FIG. 3 is a rear view of the mobile phone of FIG. 1;
FIG. 4 is a left-side view of the mobile phone of FIG. 1;
FIG. 5 is a right-side view of the mobile phone of FIG. 1;
FIG. 6 is a top plan view of the mobile phone of FIG. 1;
FIG. 7 is a bottom plan view of the mobile phone of FIG. 1;
and,
FIG. 8 is an open perspective view of the mobile phone of FIG. 1.

1 Claim, 6 Drawing Sheets

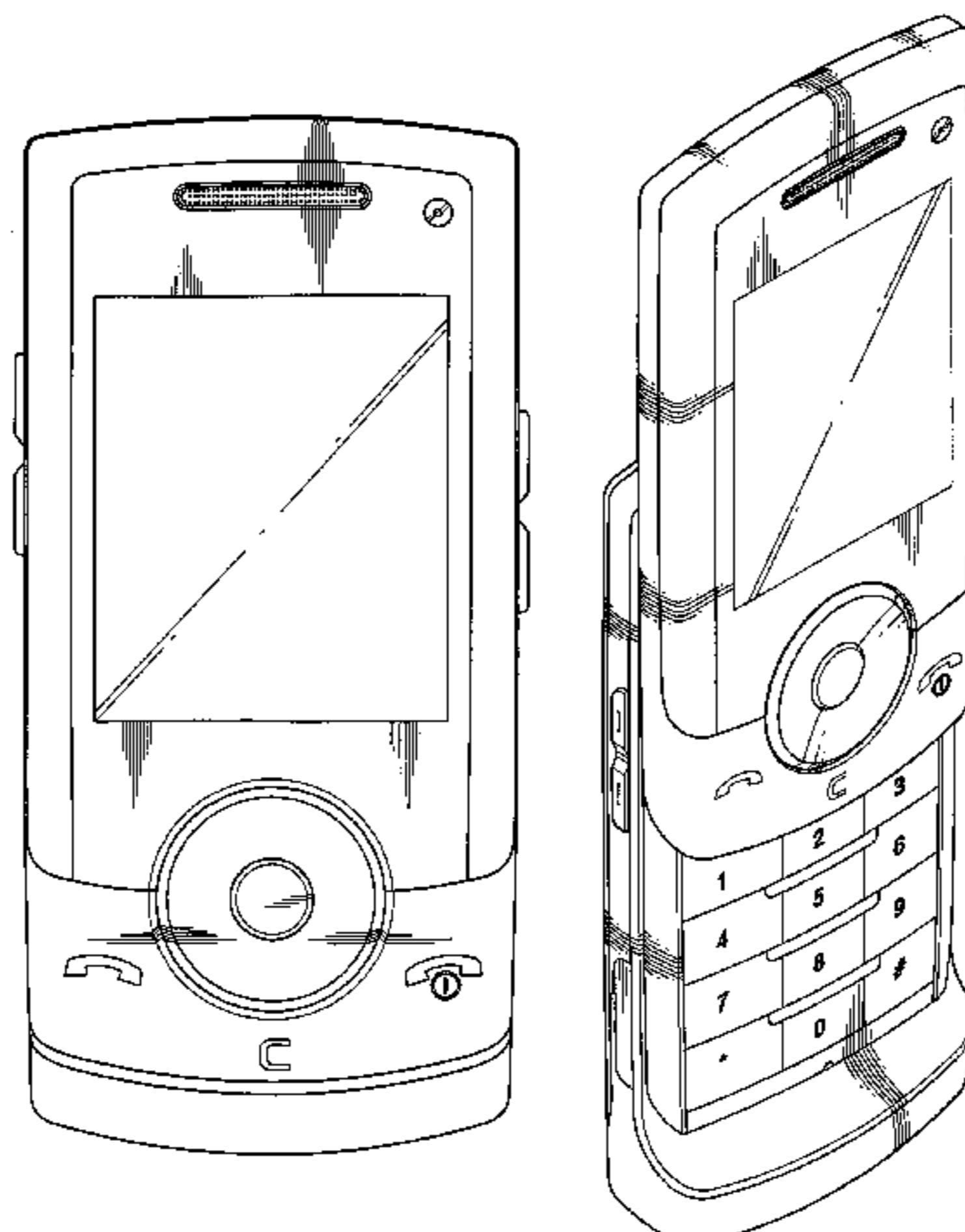

FIG. 1

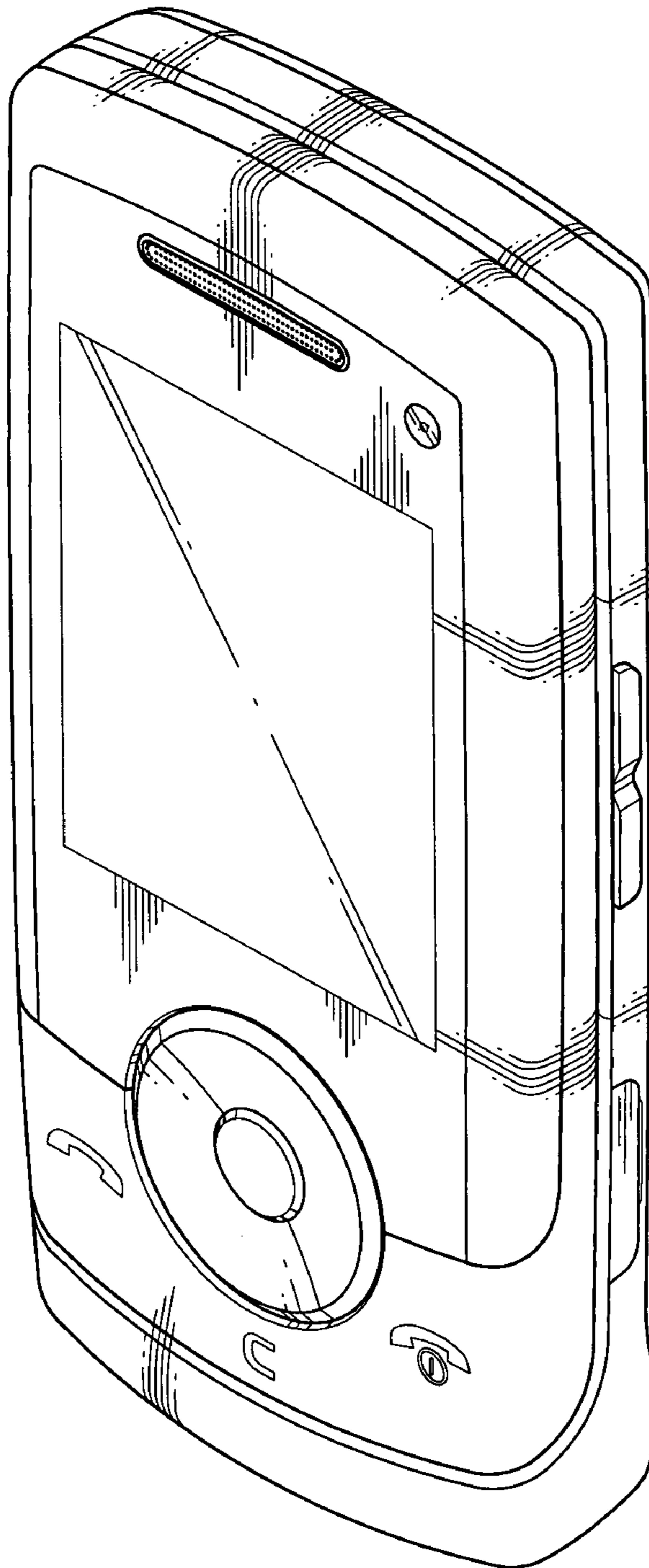

FIG.2

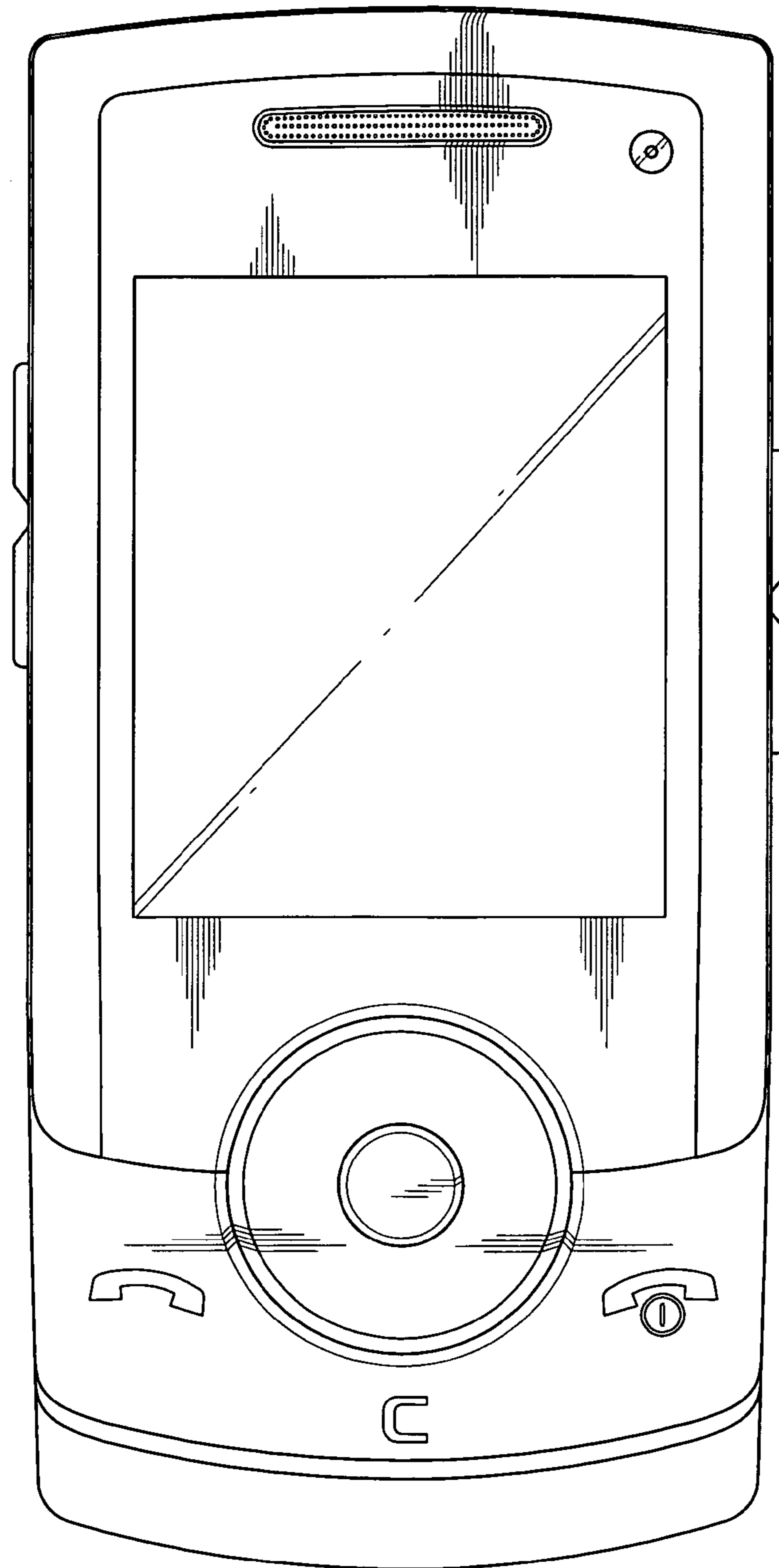

FIG.3

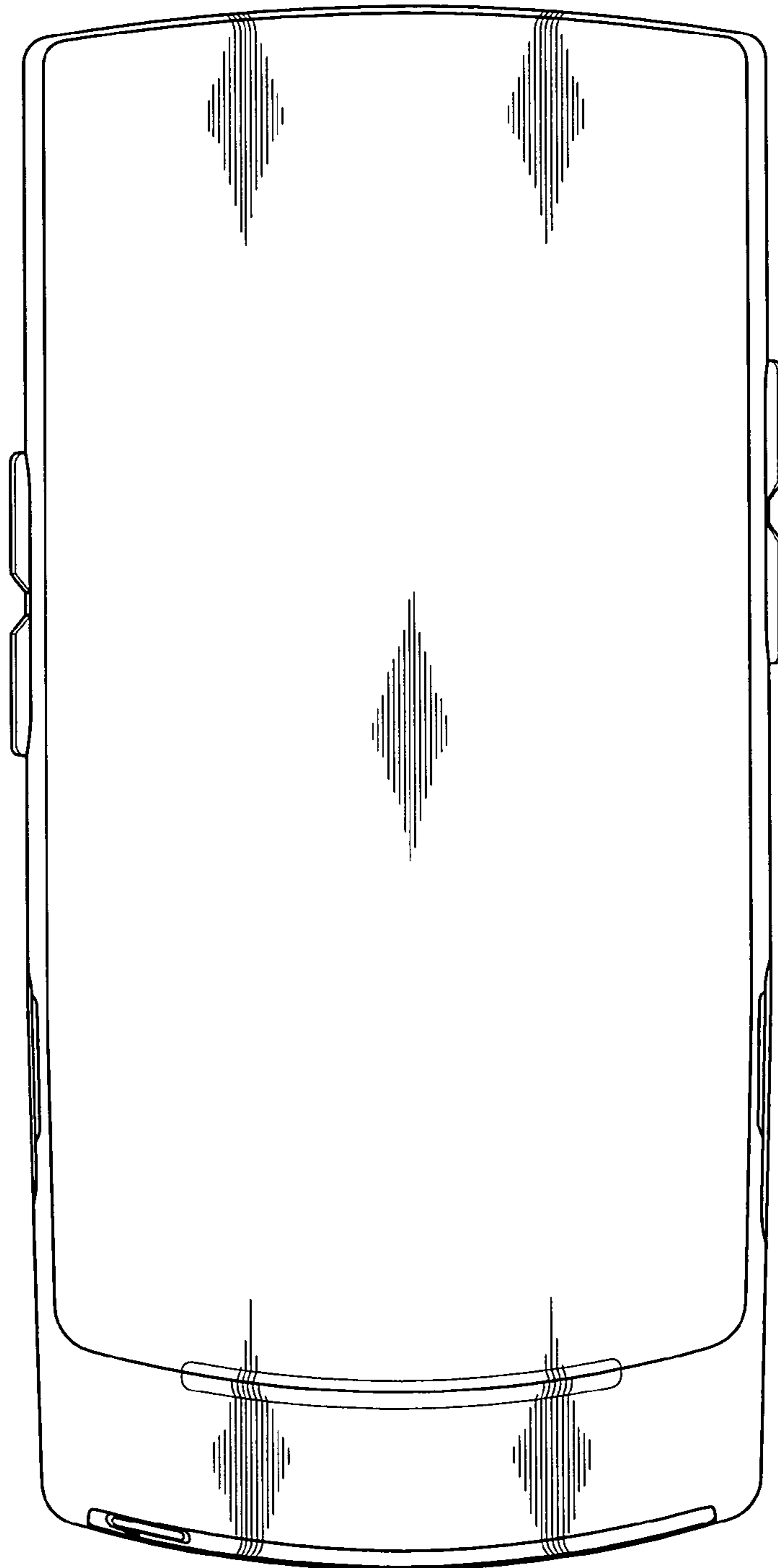

FIG.4

FIG.5

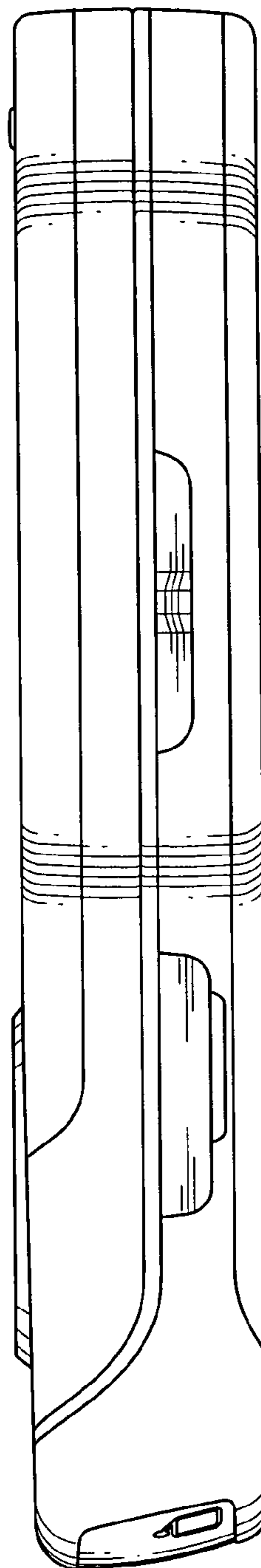
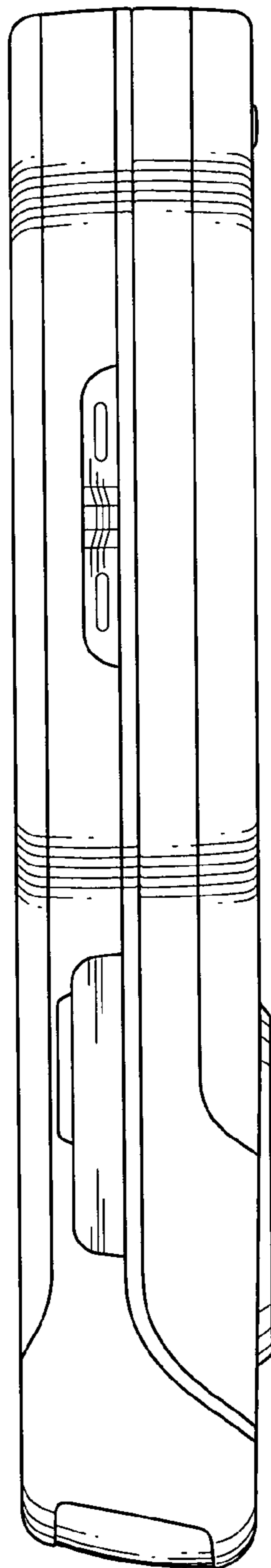

FIG.6

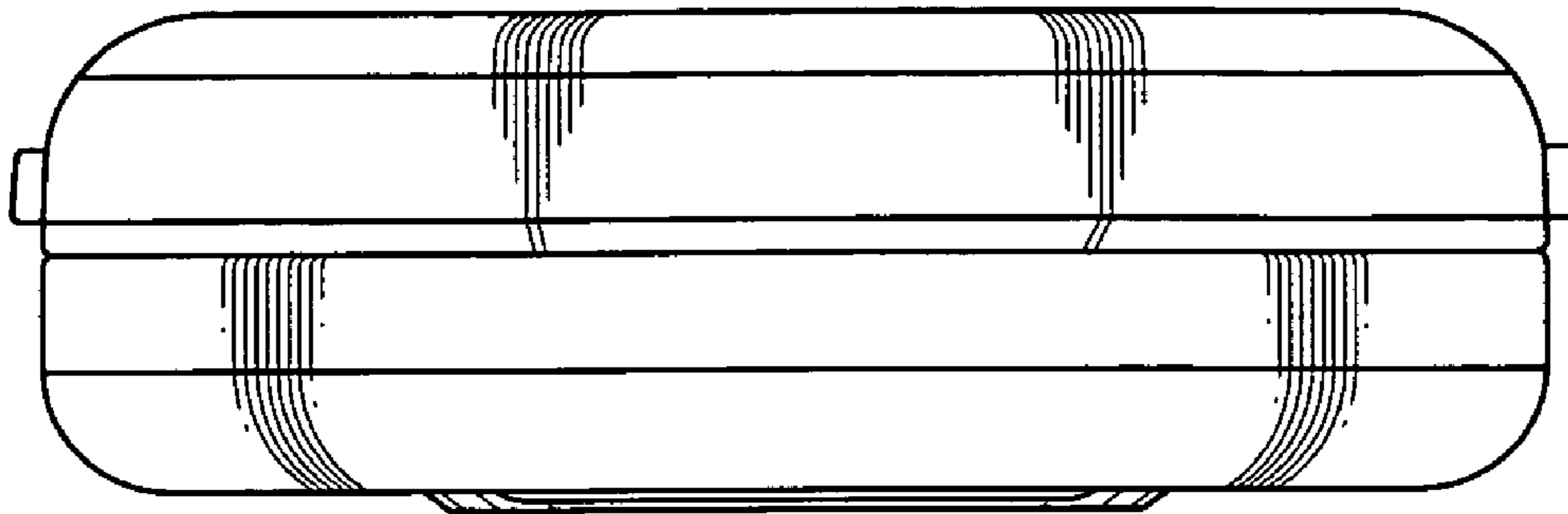

FIG.7

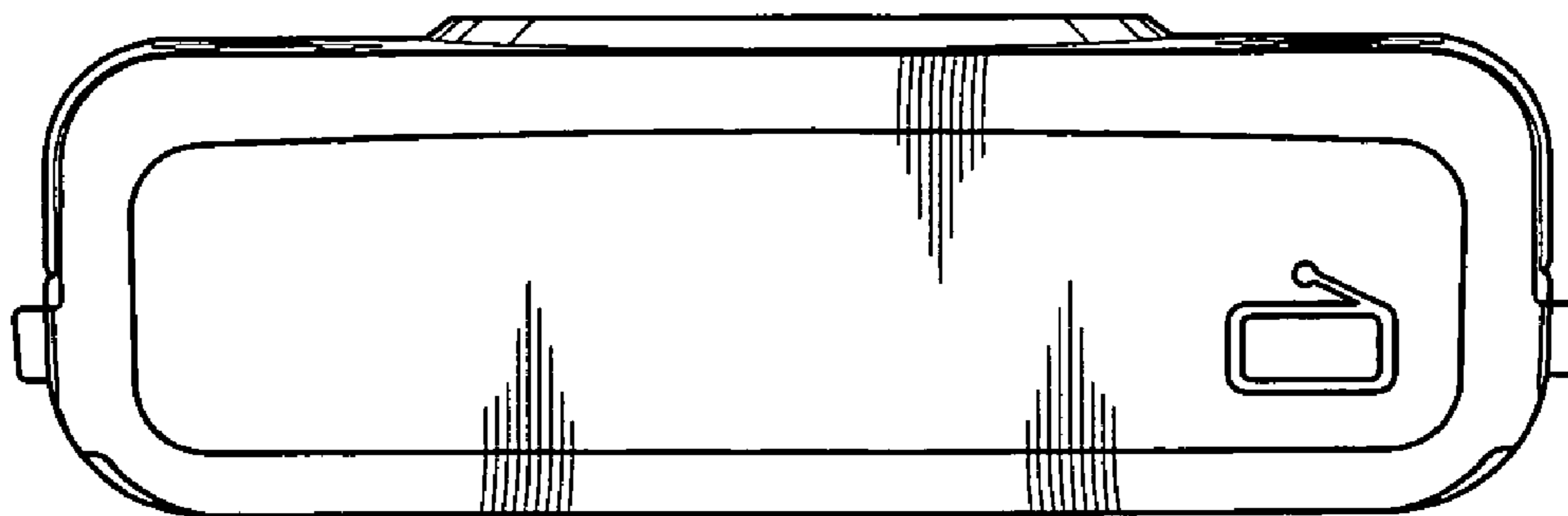

FIG. 8

