



US00D590767S

(12) **United States Design Patent**
Brantley et al.

(10) **Patent No.:** **US D590,767 S**

(45) **Date of Patent:** **** Apr. 21, 2009**

(54) **PORTABLE FUEL CELL SYSTEM WITH
REMOVABLE POWER ADAPTOR**

(75) Inventors: **Jennifer E. Brantley**, Dublin, CA (US);
Ian W. Kaye, Livermore, CA (US);
Robert David Richardson, Danville,
CA (US); **Gerry Tucker**, Pleasanton,
CA (US)

(73) Assignee: **Ultracell Corporation**, Livermore, CA
(US)

(**) Term: **14 Years**

(21) Appl. No.: **29/326,017**

(22) Filed: **Oct. 9, 2008**

(51) **LOC (9) Cl.** **13-02**

(52) **U.S. Cl.** **D13/101**

(58) **Field of Classification Search** D13/101,
D13/110, 113, 114, 118, 184, 199; D3/272,
D3/276, 281; D9/414, 432; 206/0.6, 0.7;
220/560.01, 560.04; 261/28, 29; 429/12,
429/17, 19, 20, 30, 34-39

See application file for complete search history.

(56) **References Cited**

U.S. PATENT DOCUMENTS

D320,190	S	*	9/1991	Hamlen	D13/103
D379,561	S	*	6/1997	Watson	D3/260
5,962,155	A	*	10/1999	Kuranaka et al.	429/20
D428,335	S	*	7/2000	Toyota et al.	D9/432
D432,495	S	*	10/2000	Sugita et al.	D13/103
6,268,077	B1	*	7/2001	Kelley et al.	429/33
6,322,920	B1	*	11/2001	Tomson	429/34
D462,050	S	*	8/2002	Smith et al.	D13/101
2002/0197522	A1	*	12/2002	Lawrence et al.	429/34
2004/0013927	A1	*	1/2004	Lawrence et al.	429/34
2006/0134470	A1		6/2006	Kaye et al.		

* cited by examiner

Primary Examiner—Prabhakar Deshmukh
Assistant Examiner—Derrick Holland
(74) *Attorney, Agent, or Firm*—Beyer Law Group LLP

(57) **CLAIM**

We claim the ornamental design for a portable fuel cell system with removable power adaptor, substantially as shown and described.

DESCRIPTION

This invention was made with Government support under Contract No. H94003-07-C-0711 awarded by the Defense Microelectronics Activity. The Government has certain rights in the invention.

FIG. 1 is an exploded front perspective view of the portable fuel cell system with removable power adaptor in accordance with the present design.

FIG. 2 is a front perspective view of the assembled portable fuel cell system with removable power adaptor.

FIG. 3 is a front view of the portable fuel cell system with removable power adaptor.

FIG. 4 is a back view of the portable fuel cell system with removable power adaptor.

FIG. 5 is a right side view of the portable fuel cell system with removable power adaptor.

FIG. 6 is a left side view of the portable fuel cell system with removable power adaptor.

FIG. 7 is a top view of the portable fuel cell system with removable power adaptor; and,

FIG. 8 is a bottom view of the portable fuel cell system with removable power adaptor.

The broken lines immediately adjacent to the shaded areas represent the boundaries of the claimed design. All other broken lines are directed to environment and are for illustrative purposes. None of the broken lines form part of the claimed design.

1 Claim, 6 Drawing Sheets

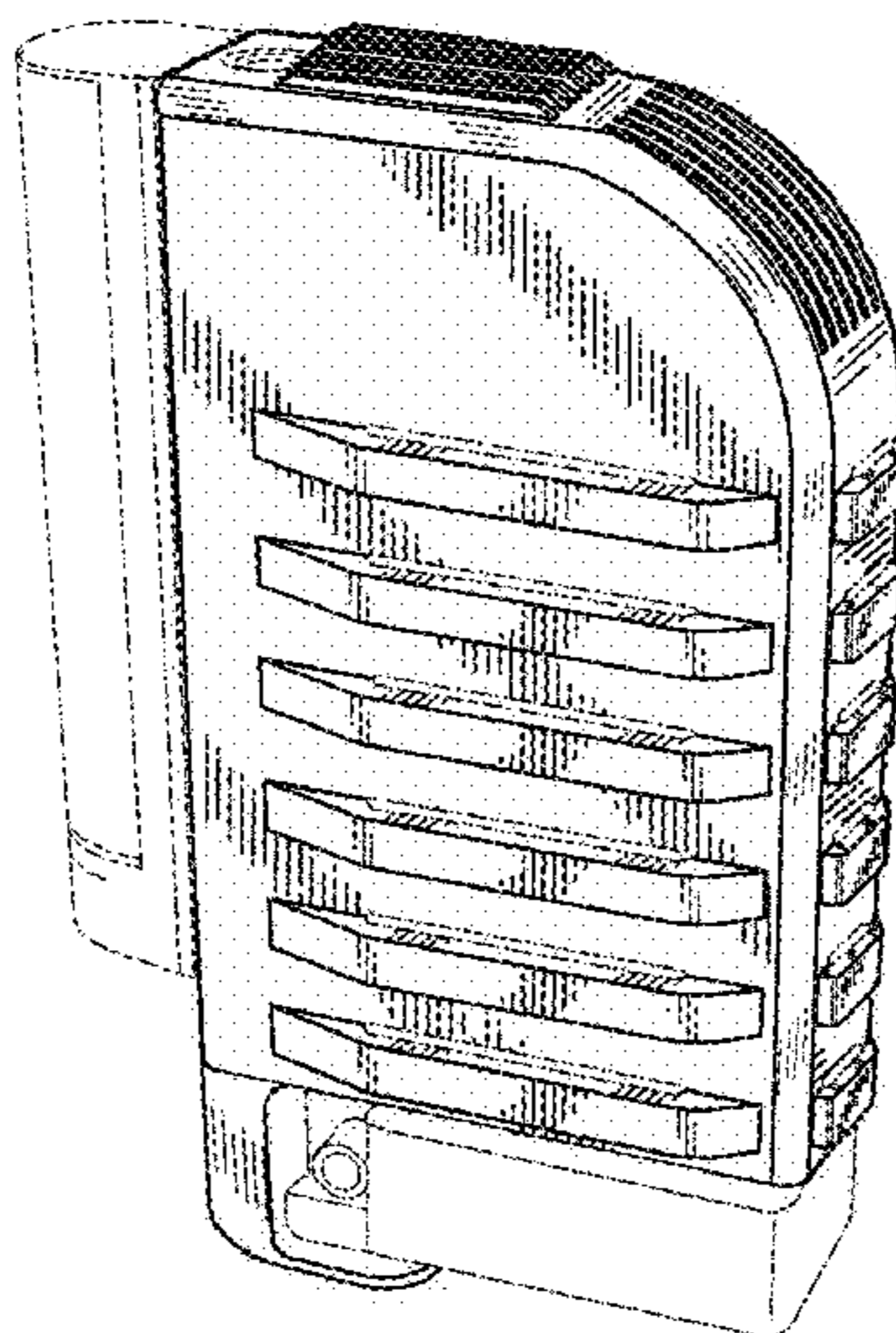

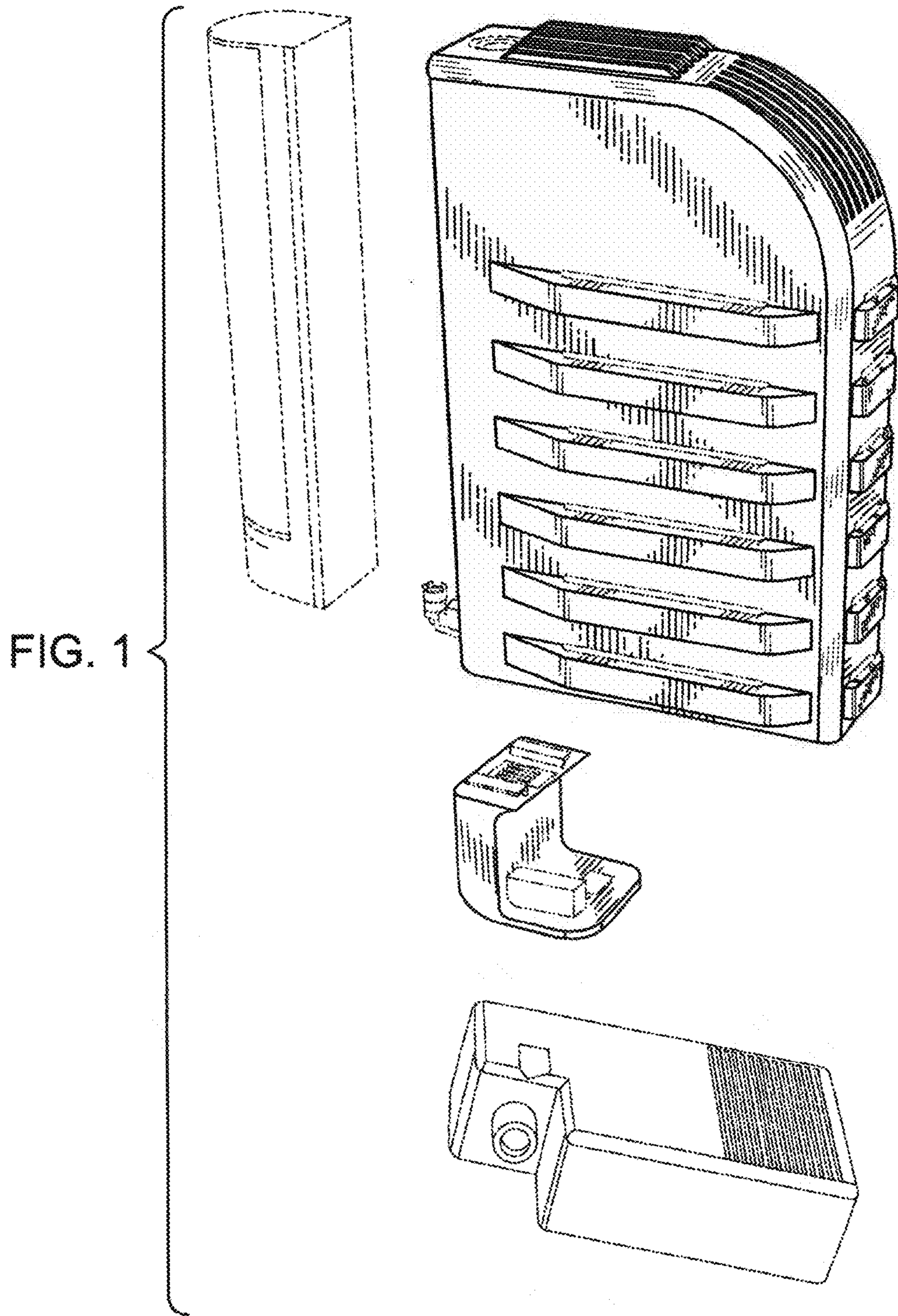

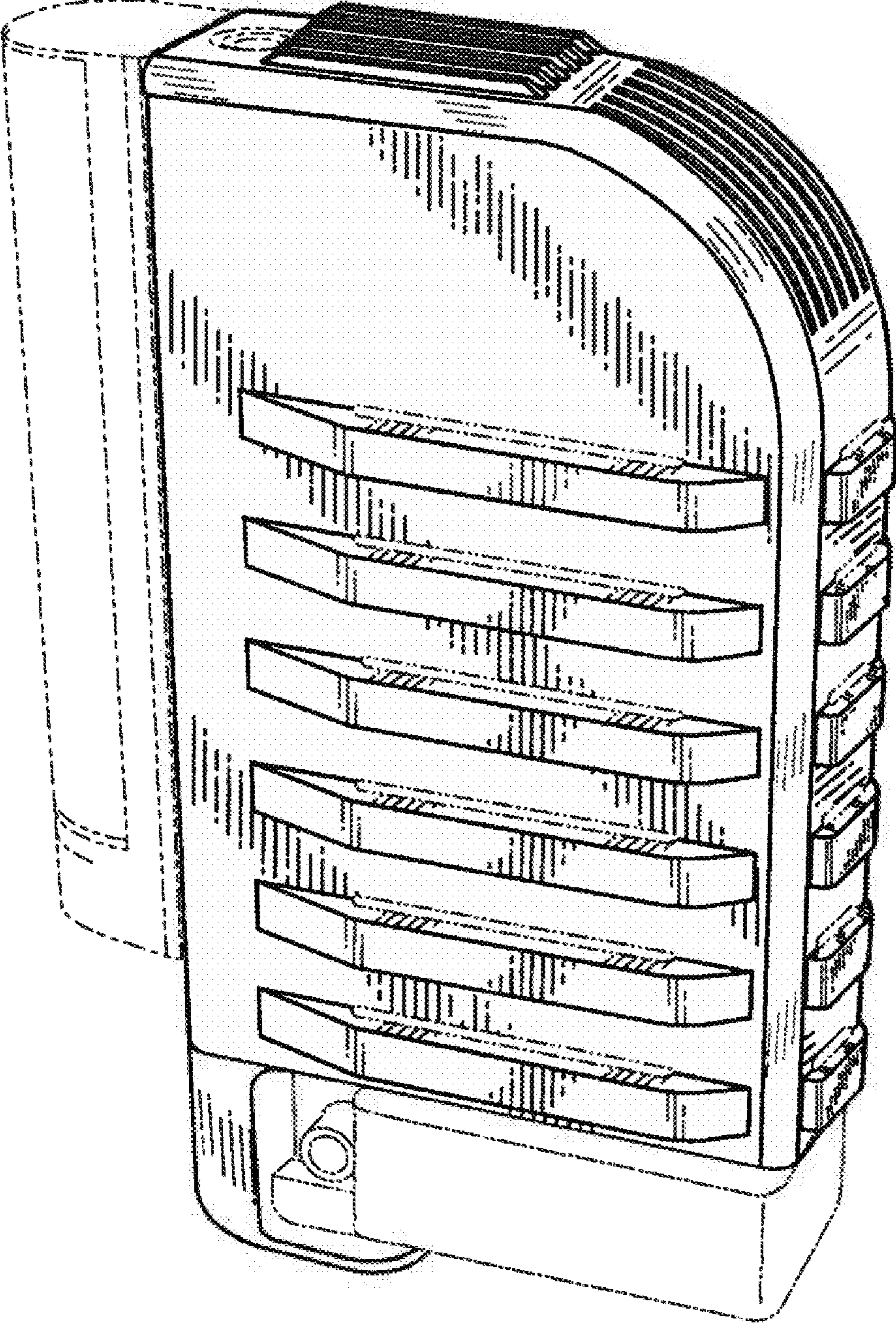

FIG. 2

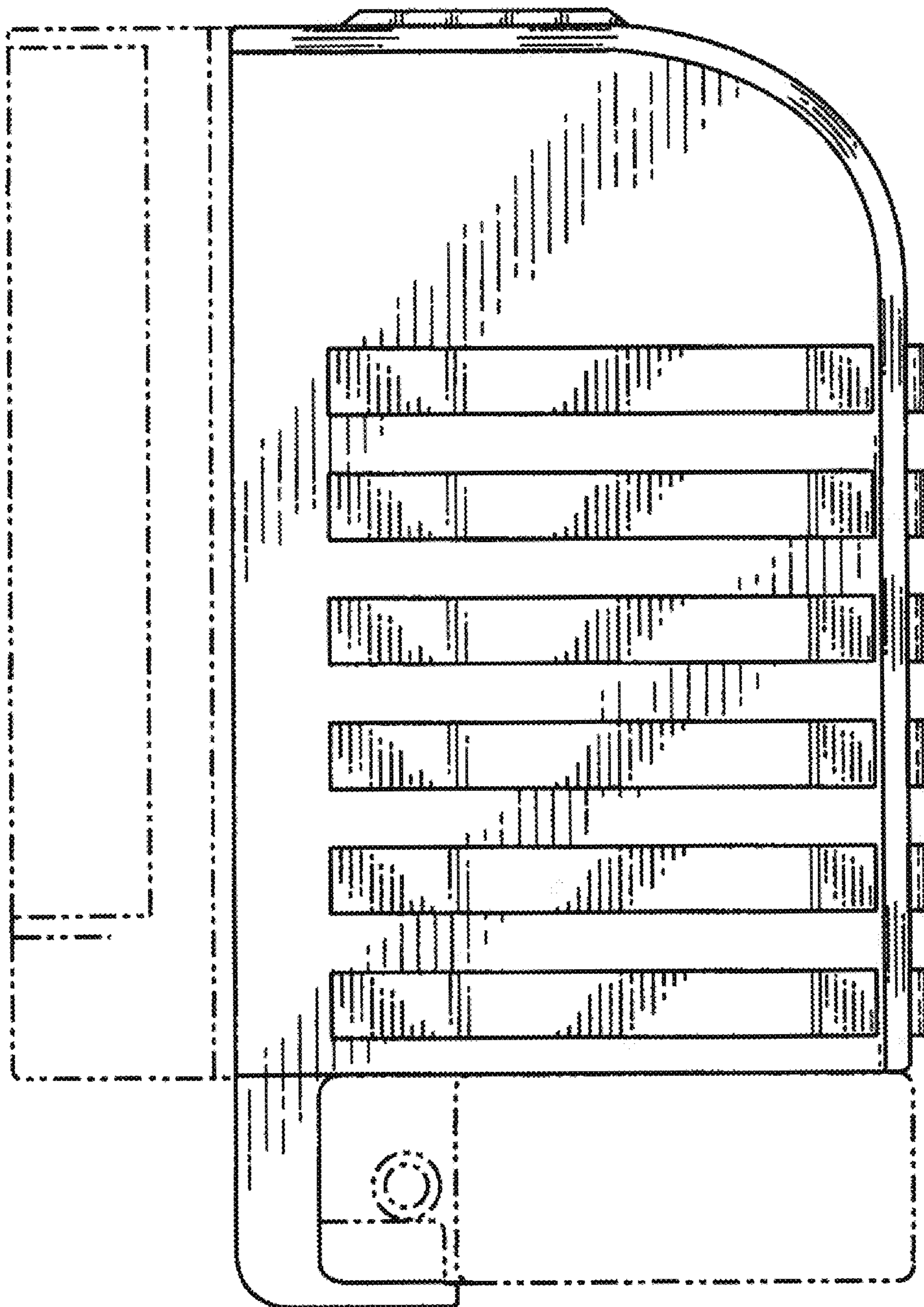

FIG. 3

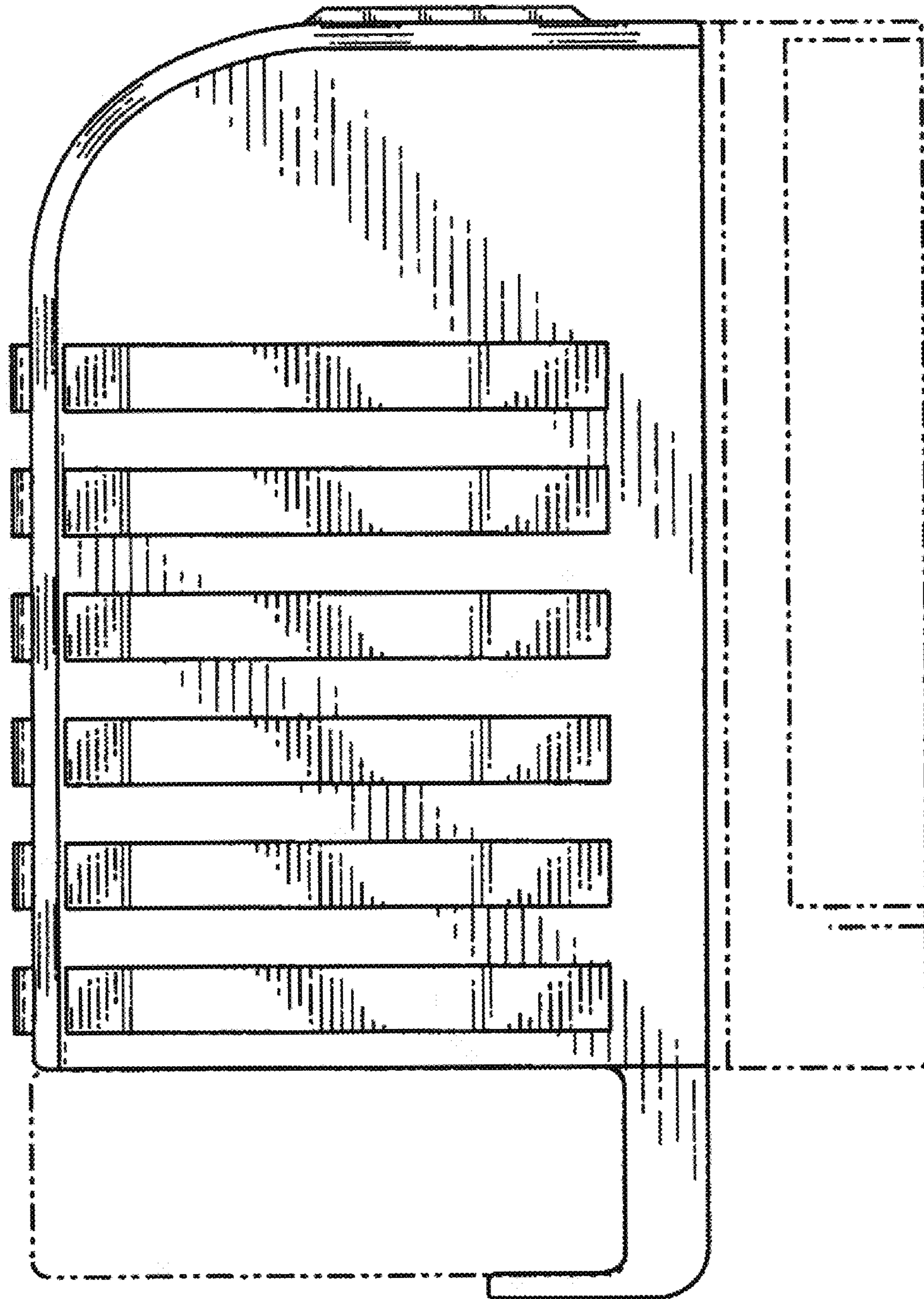

FIG. 4

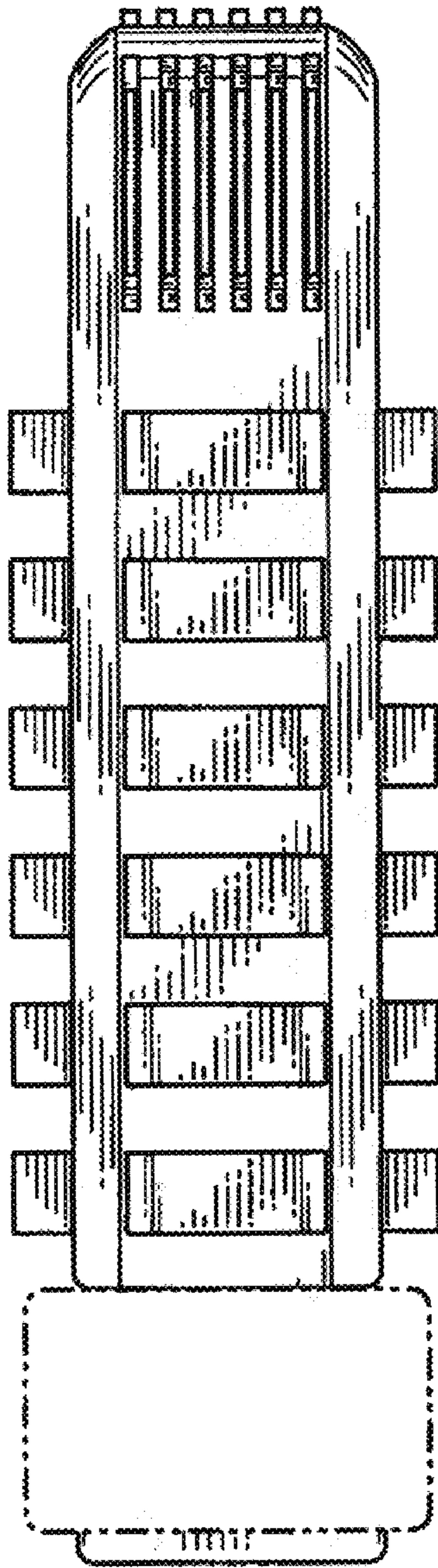

FIG. 5

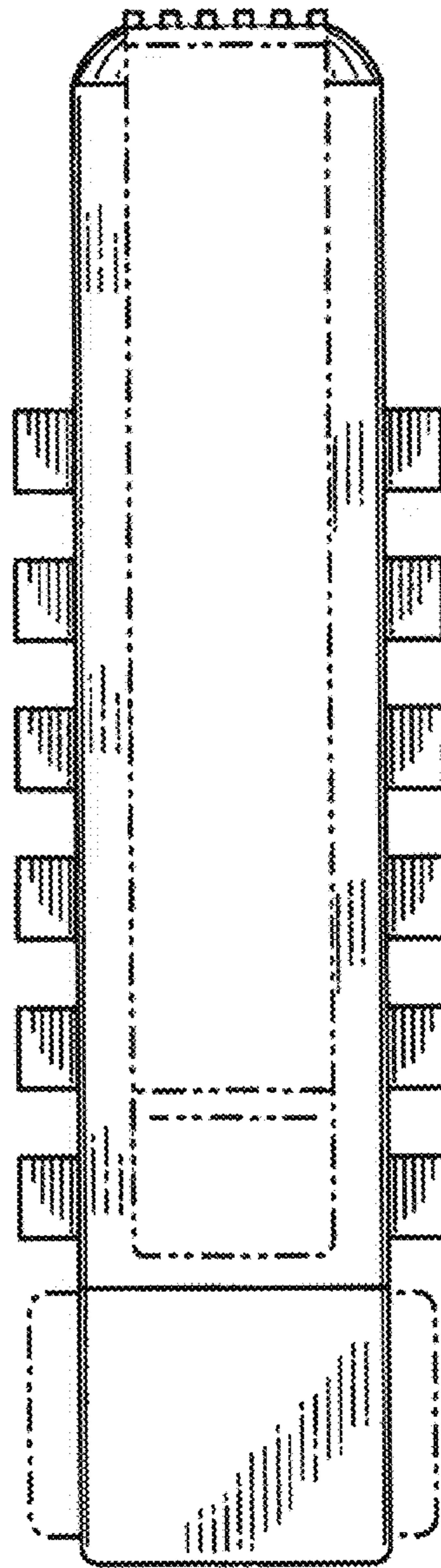

FIG. 6

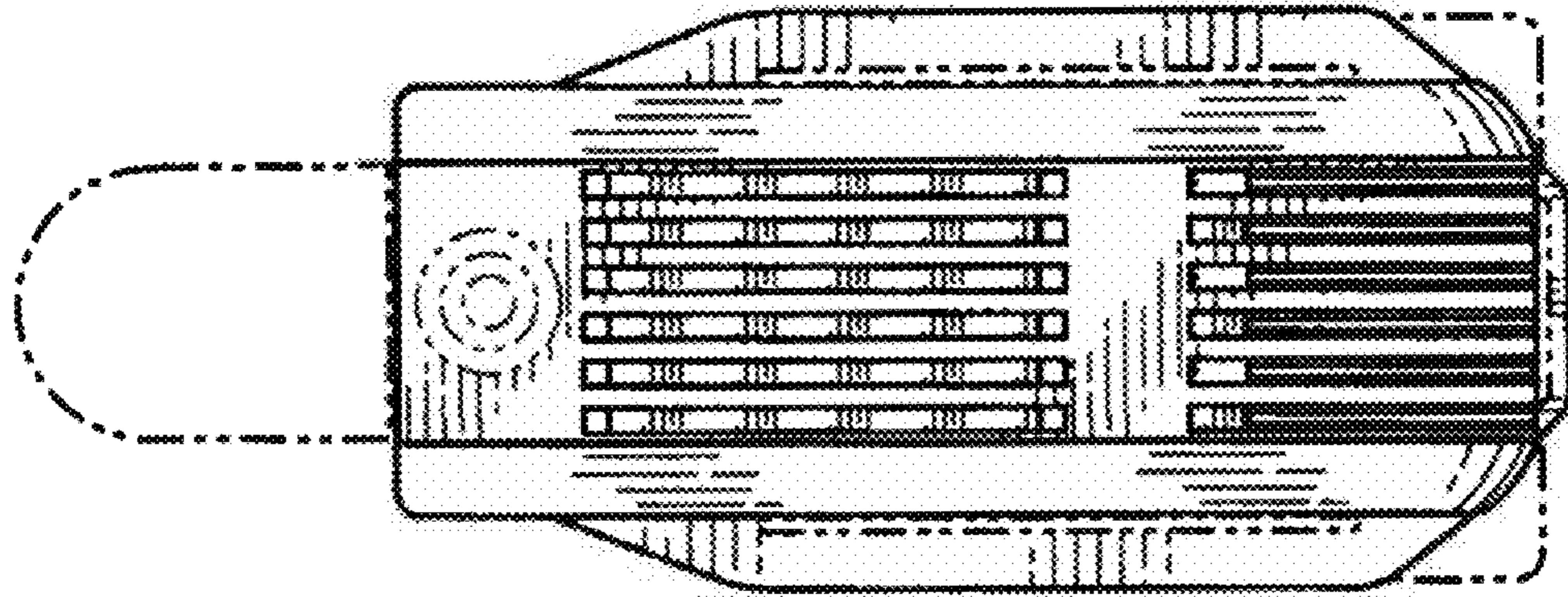

FIG. 7

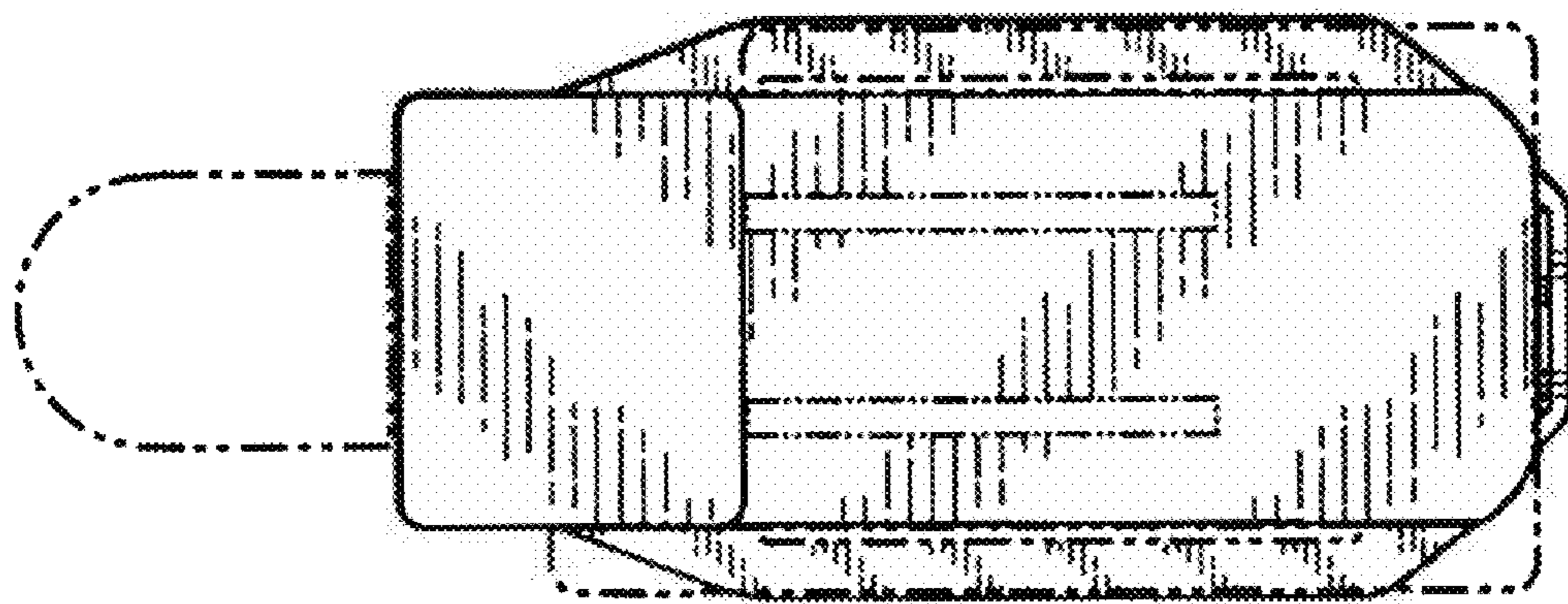

FIG. 8