



US00D590733S

(12) **United States Design Patent**  
**Deguglimo et al.**

(10) **Patent No.:** **US D590,733 S**

(45) **Date of Patent:** **\*\* Apr. 21, 2009**

(54) **TAPE MEASURE**

5,079,851 A \* 1/1992 Sill ..... D10/72  
D331,542 S \* 12/1992 Jacoff ..... D10/72

(75) Inventors: **Joe Deguglimo**, Boca Raton, FL (US);  
**Michael Garcia**, Oakland Park, FL  
(US); **Glenn Robinson**, Coral Springs,  
FL (US)

\* cited by examiner

*Primary Examiner*—Antoine D Davis  
(74) *Attorney, Agent, or Firm*—Steven M. Greenberg, Esq.;  
Scott D. Paul, Esq.; Casey Rodriguez Greenberg & Paul LLP

(73) Assignee: **IBT Holdings, LLC**, Deerfield Beach,  
FL (US)

(57) **CLAIM**

(\*\*) Term: **14 Years**

The ornamental design for a tape measure, as shown and described.

(21) Appl. No.: **29/326,613**

(22) Filed: **Oct. 21, 2008**

**DESCRIPTION**

**Related U.S. Application Data**

FIG. 1 is a front view of a tape measure according to my new design.

(63) Continuation of application No. 29/305,744, filed on  
Mar. 27, 2008, now Pat. No. Des. 578,910.

FIG. 2 is a rear view of the tape measure thereof.

(51) **LOC (9) Cl.** ..... **10-04**

(52) **U.S. Cl.** ..... **D10/74**

(58) **Field of Classification Search** ..... D10/72;  
33/755-771; 242/292, 381.1, 381.2, 381.3,  
242/381.4, 381.5, 381.6

FIG. 3 is a right side view of the tape measure thereof.

FIG. 4 is a left side view of the tape measure thereof.

FIG. 5 is a top view of the tape measure thereof.

FIG. 6 is a bottom view of the tape measure thereof.

FIG. 7 is a front view perspective of the tape measure thereof;  
and,

FIG. 8 is a rear view perspective of the tape measure thereof.

See application file for complete search history.

The broken lines are for illustrative purposes only and form  
no part of the claimed design.

(56) **References Cited**

**U.S. PATENT DOCUMENTS**

D319,405 S \* 8/1991 Brawne ..... D10/72

**1 Claim, 8 Drawing Sheets**

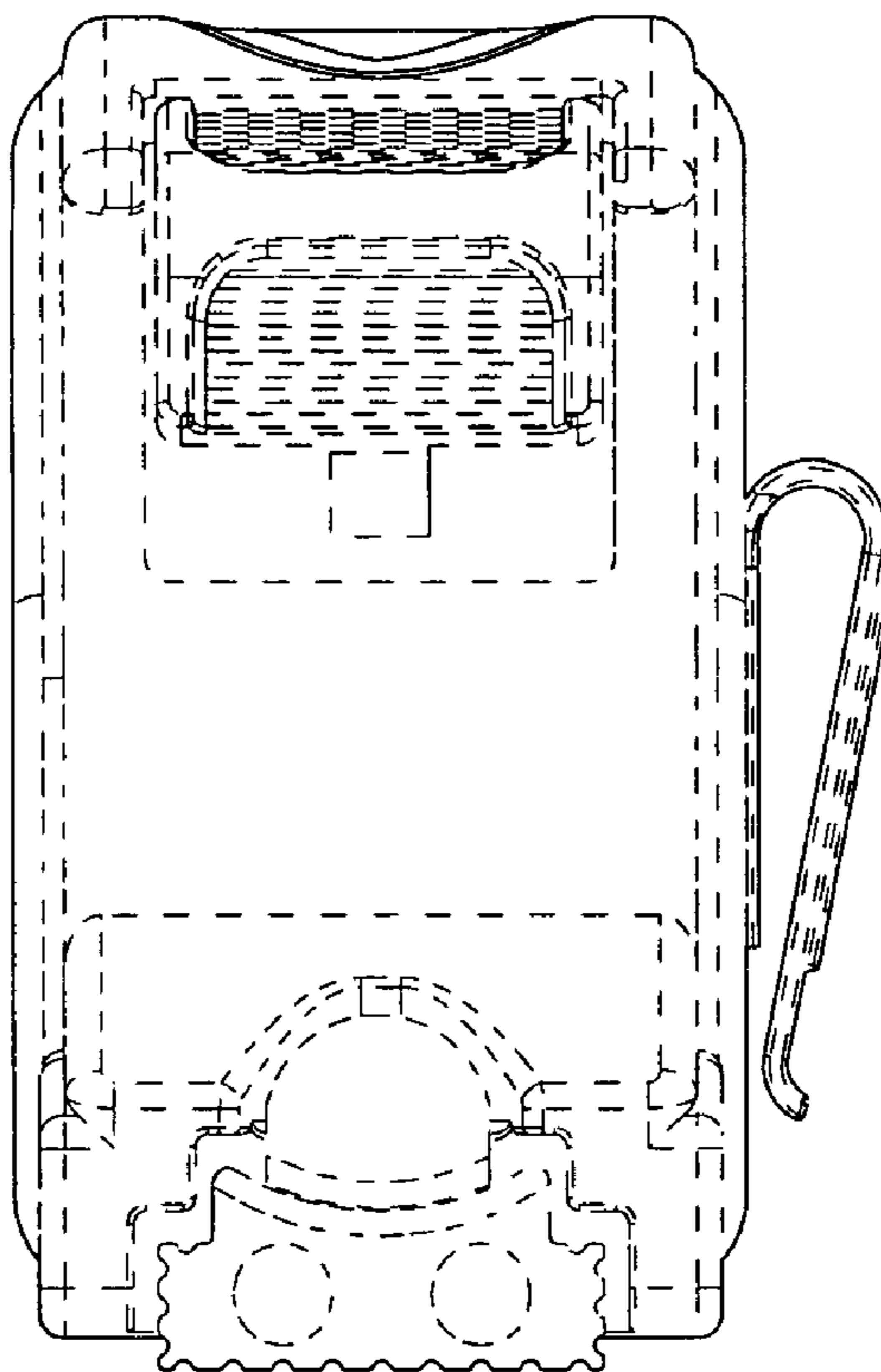

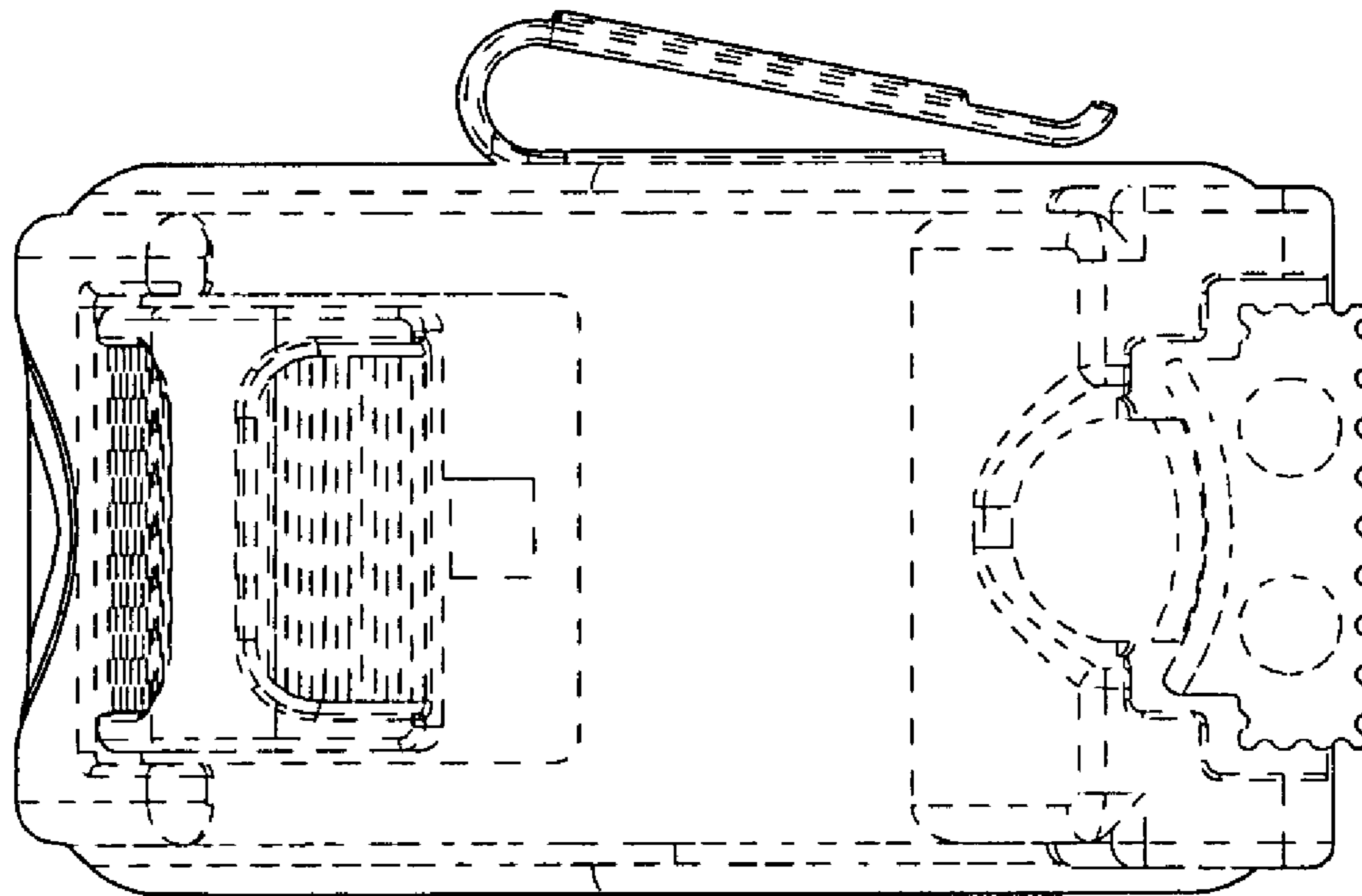

Fig. 1

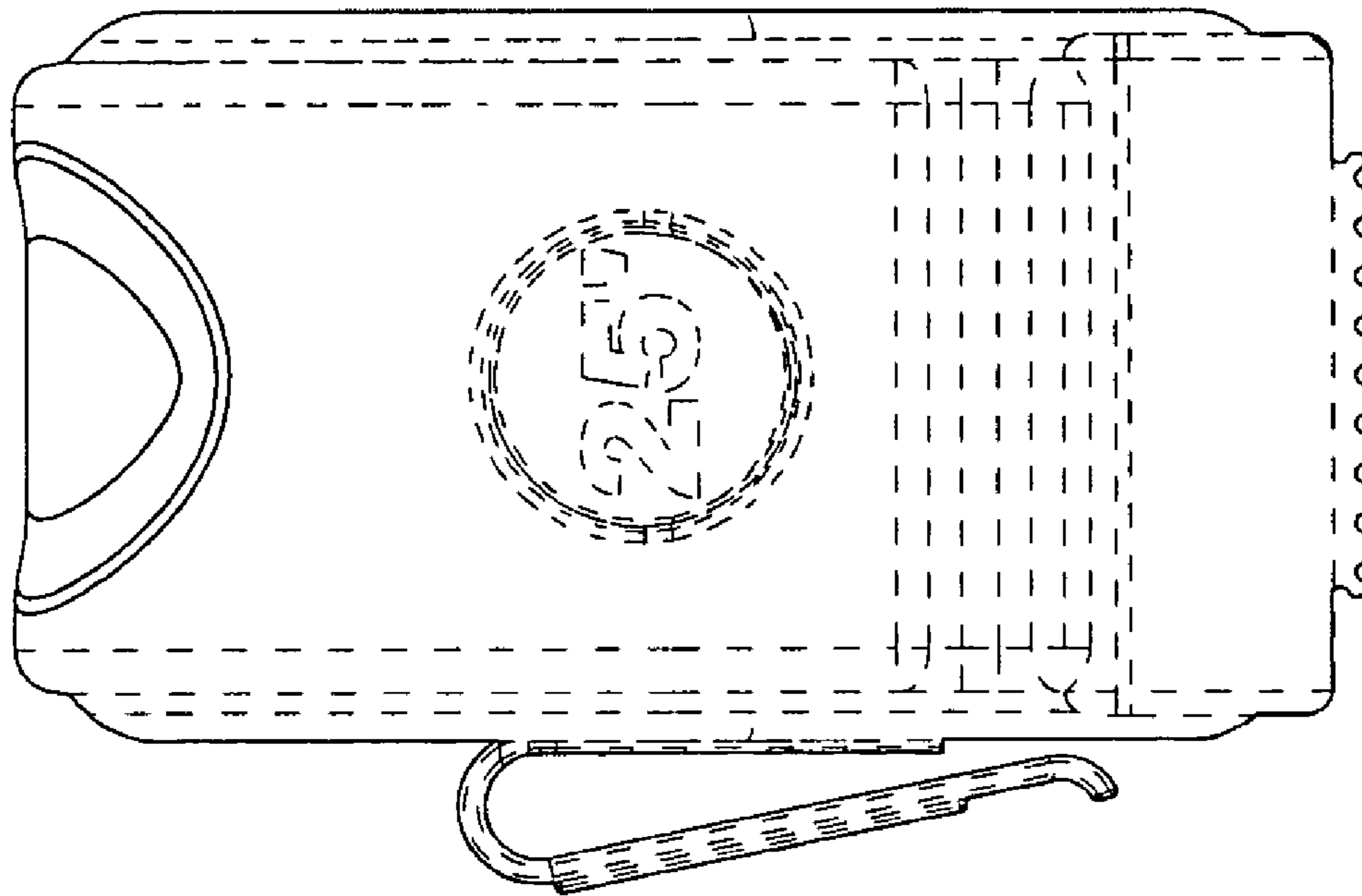

Fig. 2

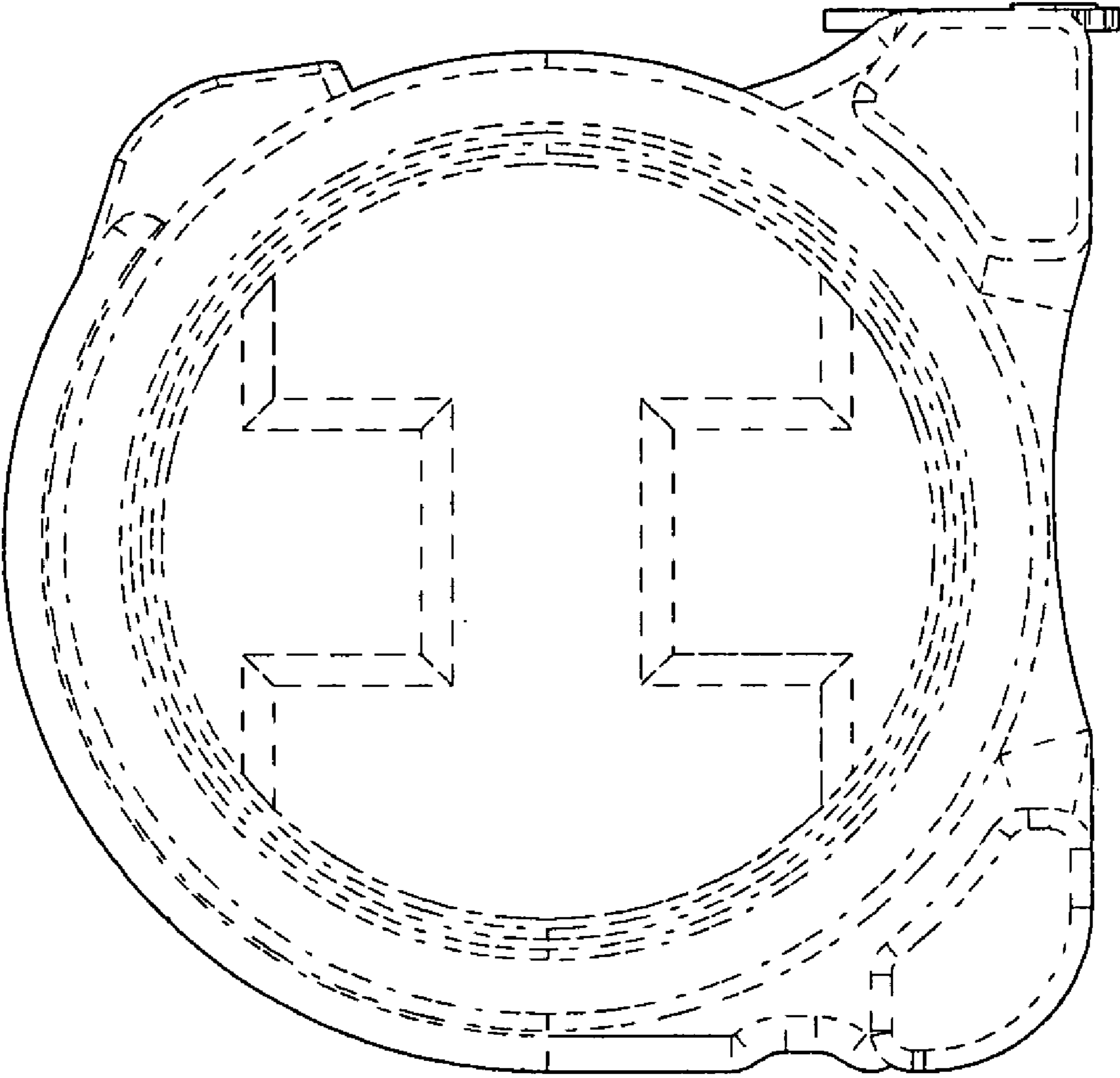

Fig. 3

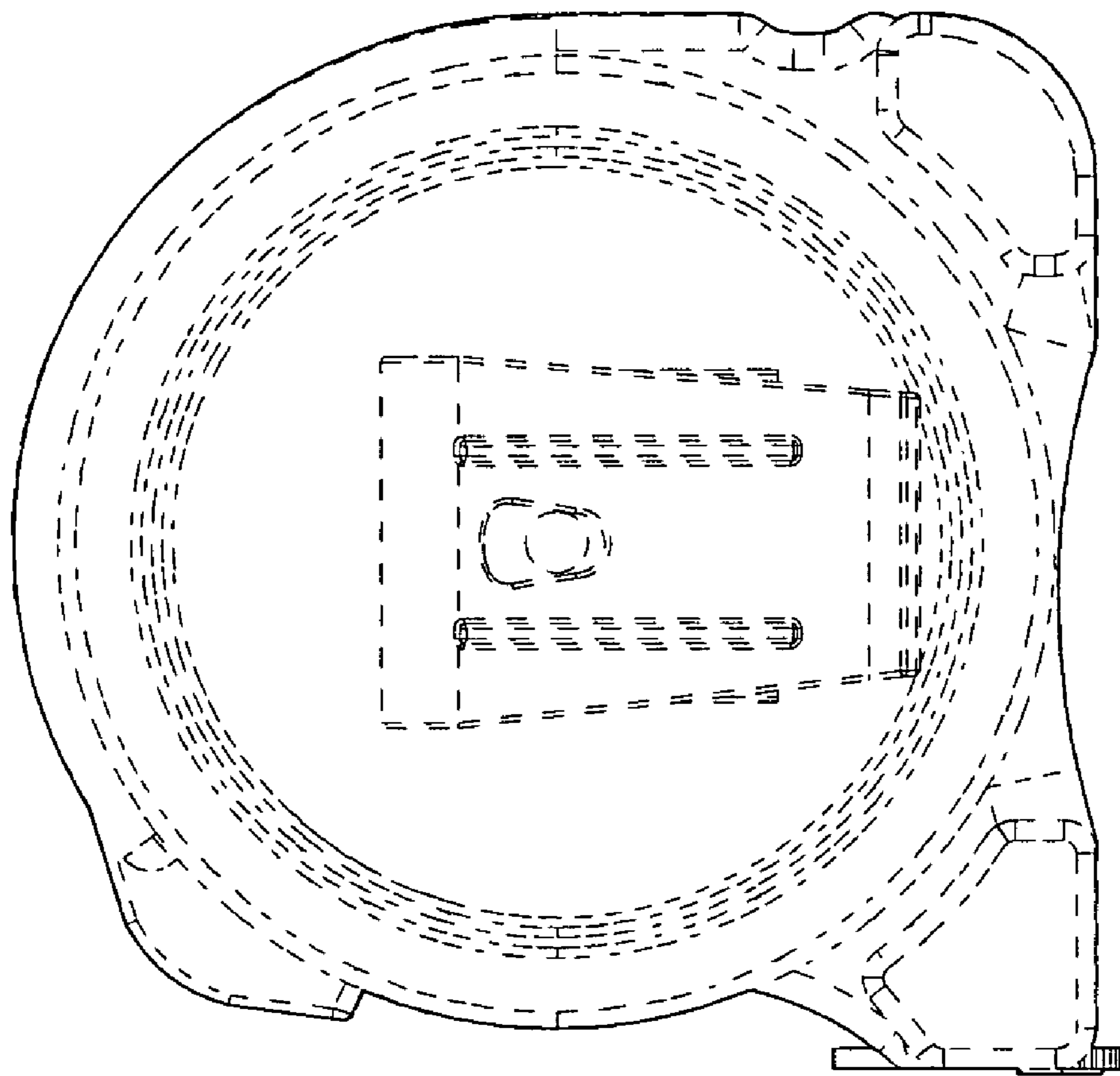

Fig. 4

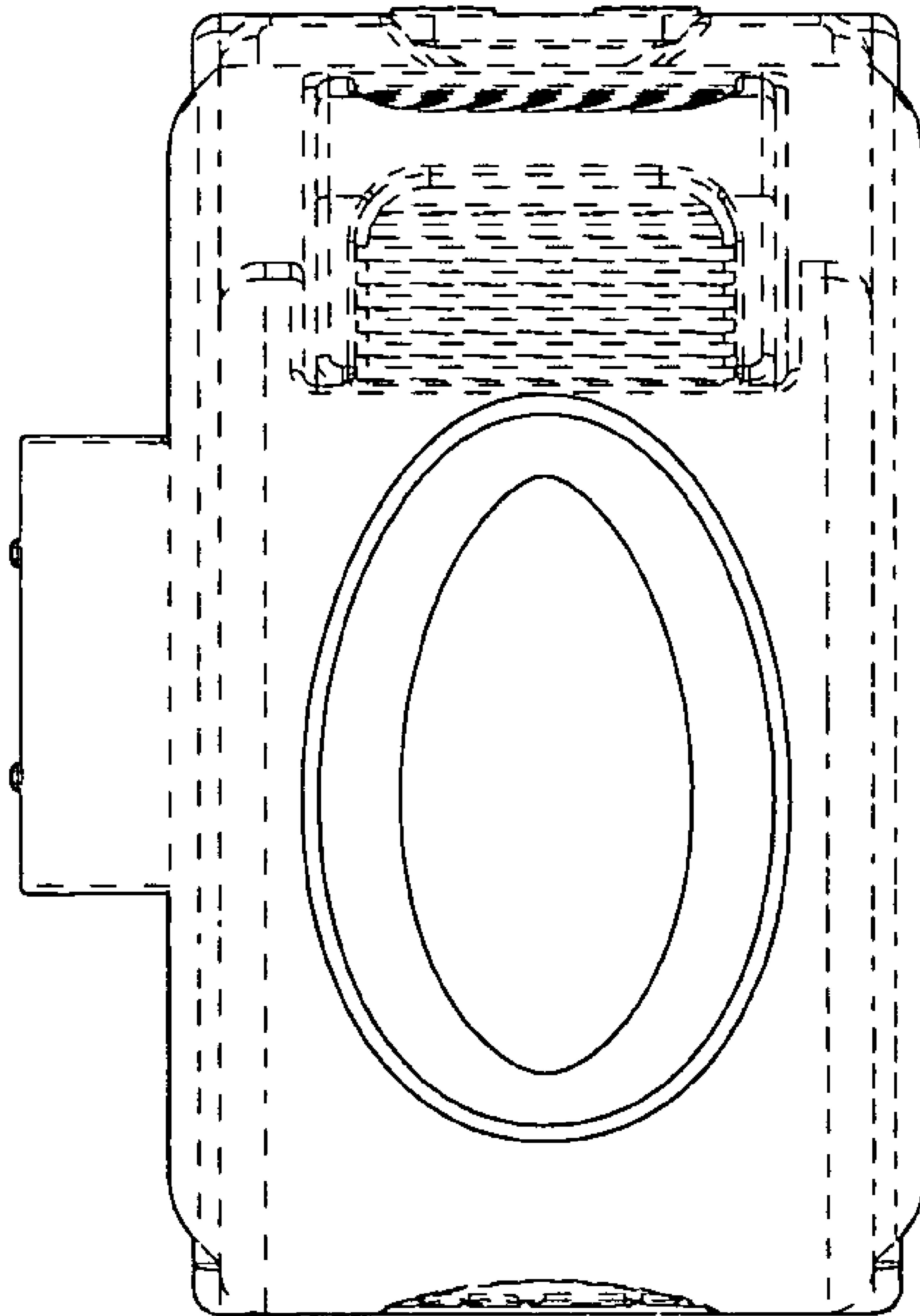

Fig. 5

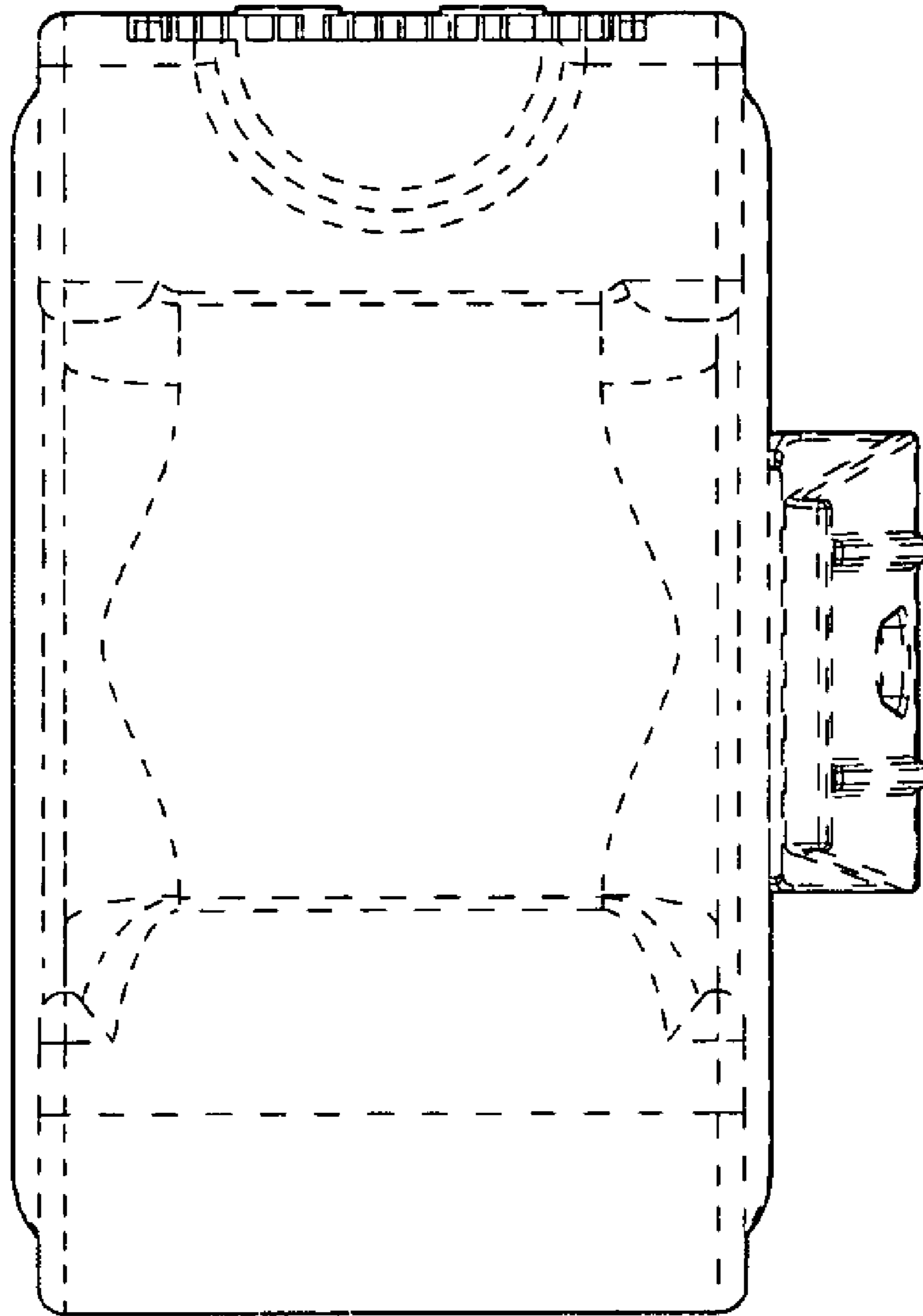

Fig. 6

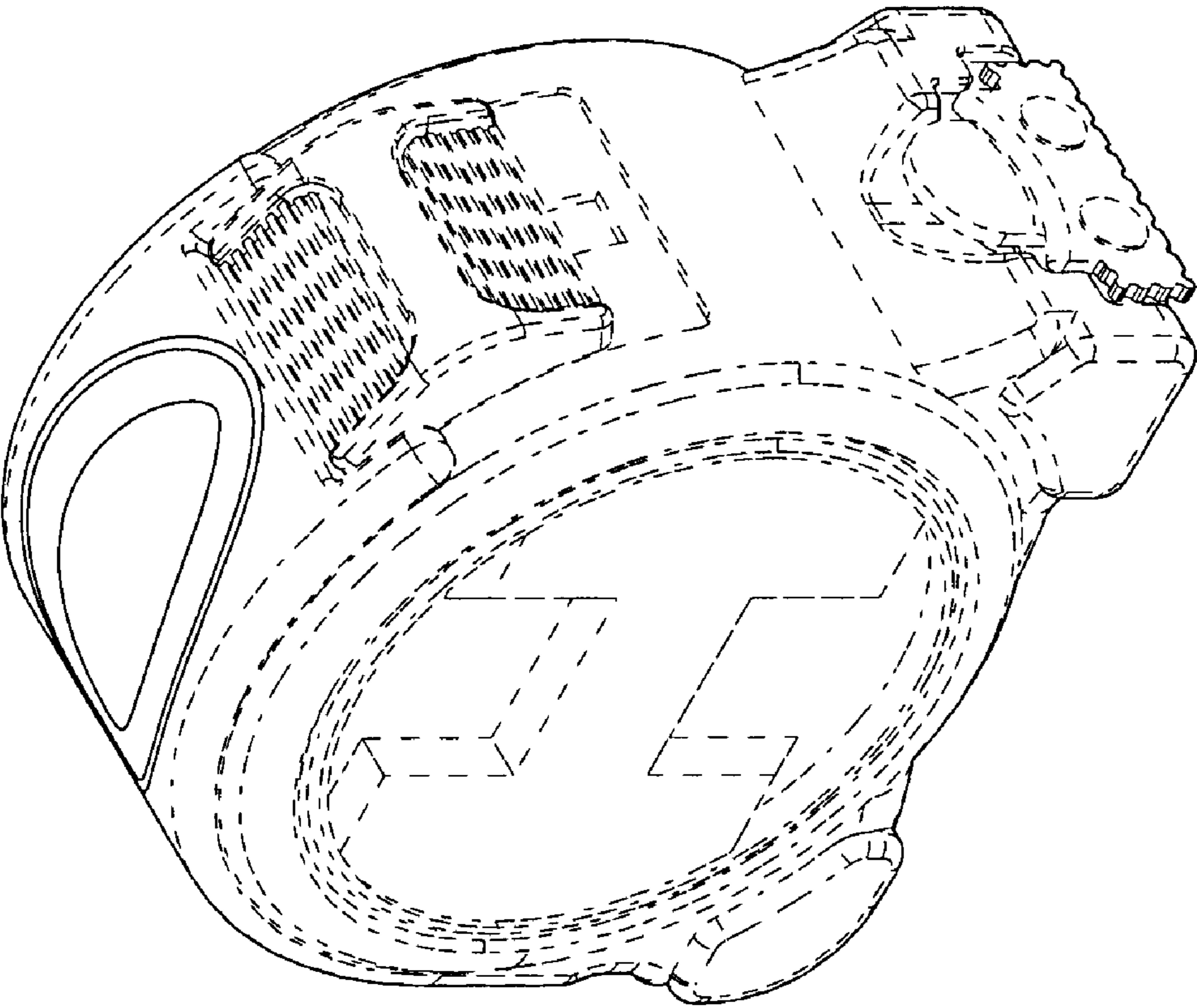

Fig. 7



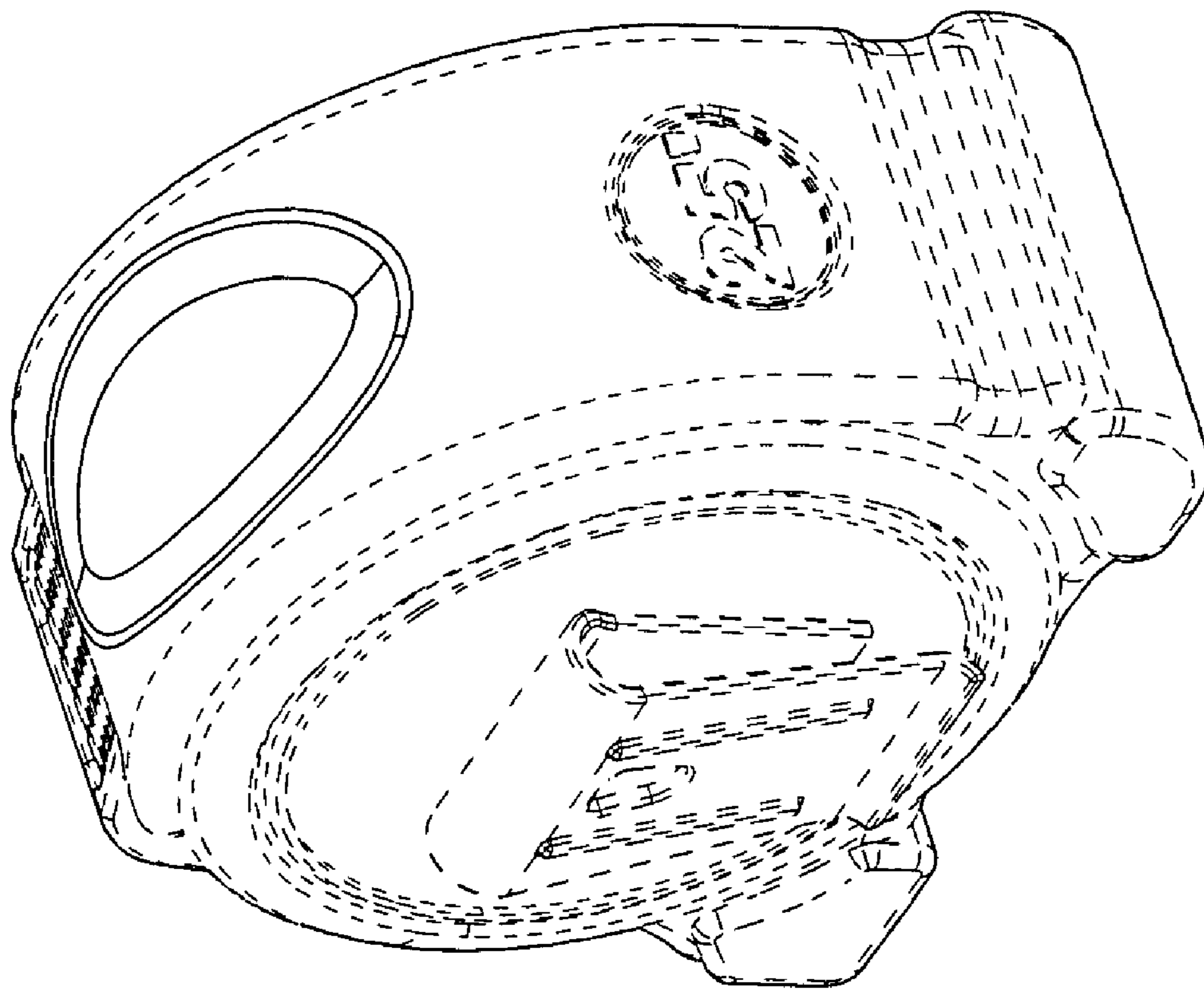

Fig. 8