



US00D590727S

(12) **United States Design Patent**
Wei

(10) **Patent No.:** **US D590,727 S**

(45) **Date of Patent:** **** Apr. 21, 2009**

(54) **WATCH CASE**

(75) Inventor: **Yang Li Wei**, Dongzhu Town (CN)

(73) Assignee: **New Heritage Ltd.**, Hong Kong (HK)

(**) Term: **14 Years**

(21) Appl. No.: **29/279,333**

(22) Filed: **Apr. 27, 2007**

(51) **LOC (9) Cl.** **10-02**

(52) **U.S. Cl.** **D10/38**

(58) **Field of Classification Search** D10/30-39;
368/276, 281, 282, 285, 308, 288
See application file for complete search history.

(56) **References Cited**

U.S. PATENT DOCUMENTS

2,361,563	A *	10/1944	Pellaton	368/80
D195,421	S *	6/1963	Huguenin	D10/39
3,740,944	A *	6/1973	Chopard	368/281
3,901,023	A *	8/1975	Uebelhardt	368/281
4,766,579	A *	8/1988	Sporring	368/190
D317,265	S *	6/1991	Giolla et al.	D10/39
5,172,351	A *	12/1992	Corlet	368/319
5,220,541	A *	6/1993	Vuilleumier	368/88
5,282,179	A *	1/1994	Vuilleumier	368/28
D423,951	S *	5/2000	Fichter	D10/39
D436,044	S *	1/2001	Subilia	D10/30
D474,118	S *	5/2003	Monachon	D10/32
6,570,823	B1 *	5/2003	Gilomen et al.	368/113
D488,724	S *	4/2004	Bertucci	D10/30

D502,413	S *	3/2005	Sugiura et al.	D10/39
7,027,360	B2 *	4/2006	Kitahara et al.	368/28
D536,628	S *	2/2007	Roth	D10/38
D538,182	S *	3/2007	Lalo	D10/32
D555,516	S *	11/2007	Sugiura	D10/31
D559,124	S *	1/2008	Modolo	D10/32
D569,276	S *	5/2008	Scheufele	D10/39

* cited by examiner

Primary Examiner—Lucy Lieberman

(74) *Attorney, Agent, or Firm*—Galbreath Law Offices, P.C.;
John A. Galbreath

(57) **CLAIM**

The ornamental design for a watch case, as shown and described.

DESCRIPTION

FIG. 1 is a perspective view of the invention;

FIG. 2 is a top view of the invention;

FIG. 3 is a bottom view of the invention;

FIG. 4 is a front view of the invention;

FIG. 5 is a back view of the invention, with the watch case inverted;

FIG. 6 is a side view of the invention, showing the side that contains the mechanism used to set the time; and,

FIG. 7 is another side view of the invention, showing the side opposite that shown in FIG. 6.

1 Claim, 2 Drawing Sheets

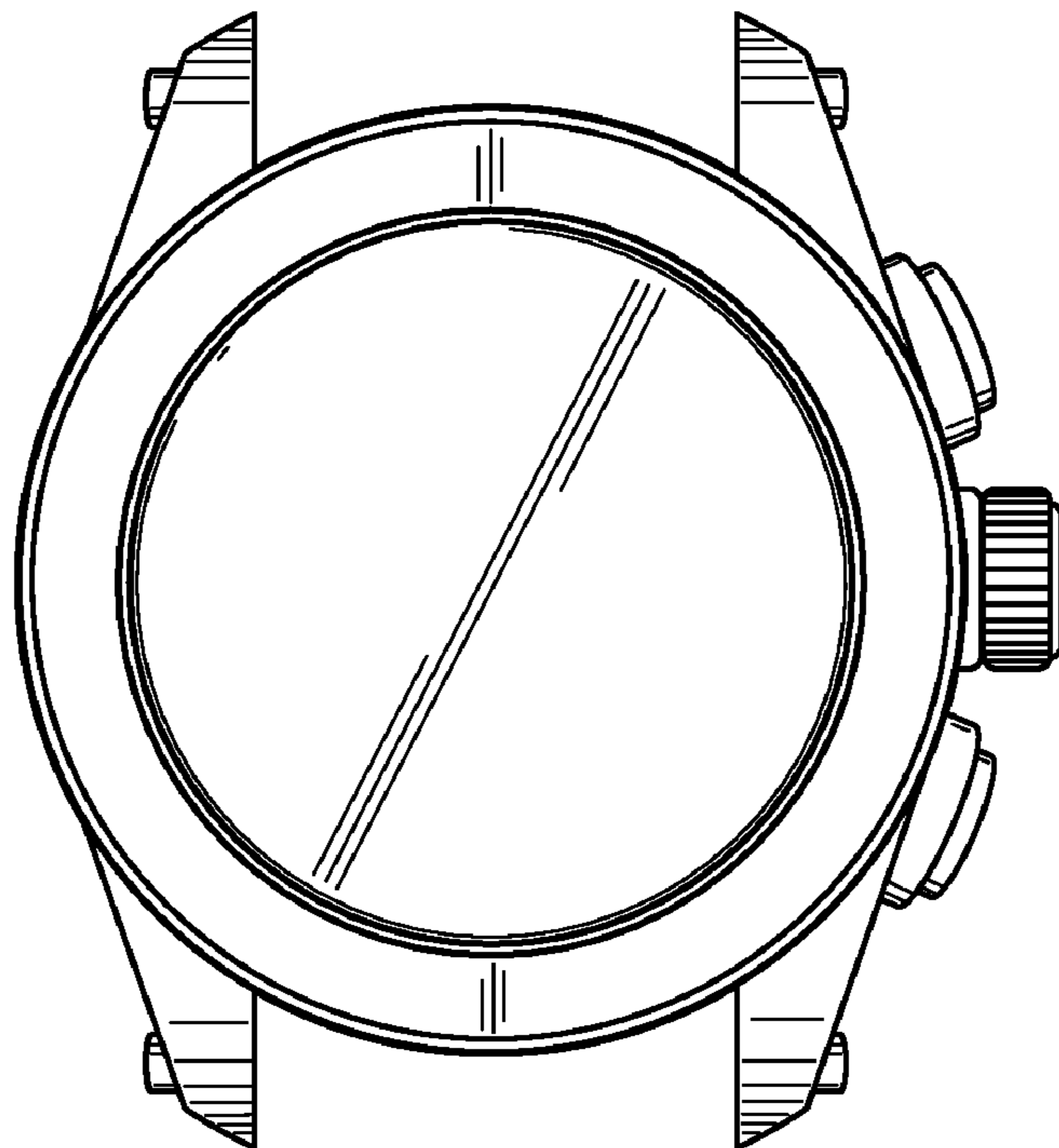

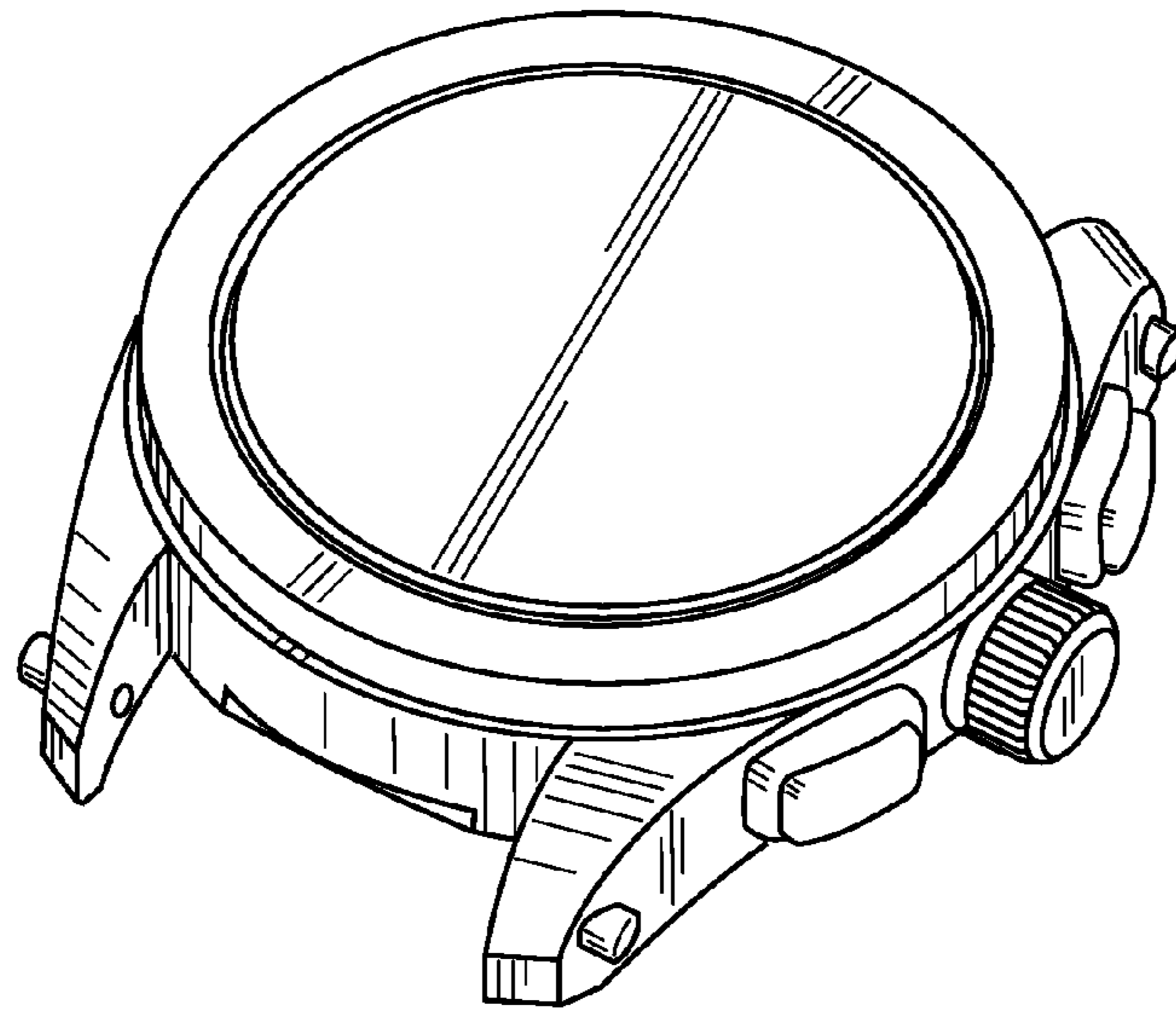

Fig. 1

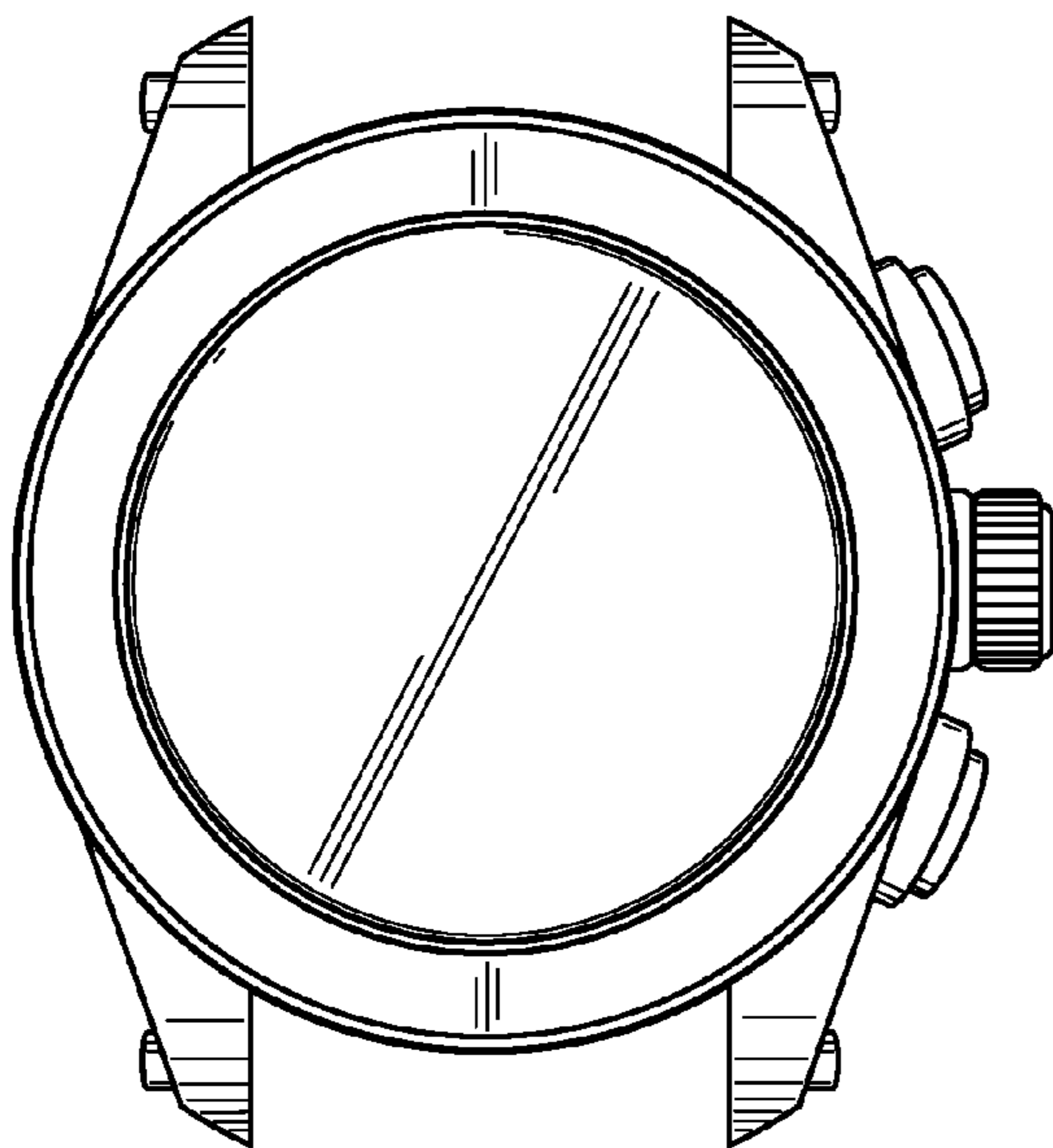

Fig. 2

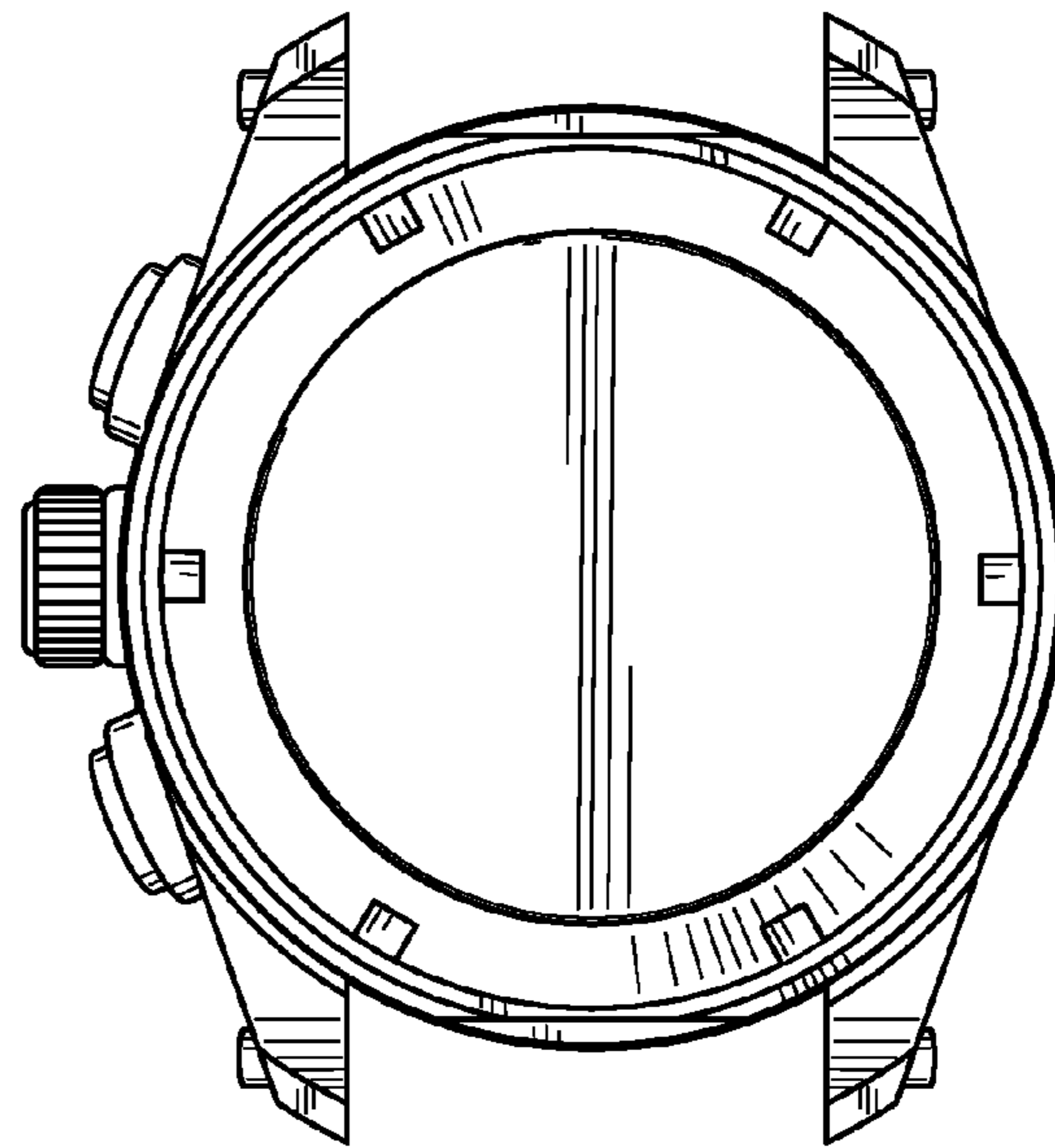

Fig. 3

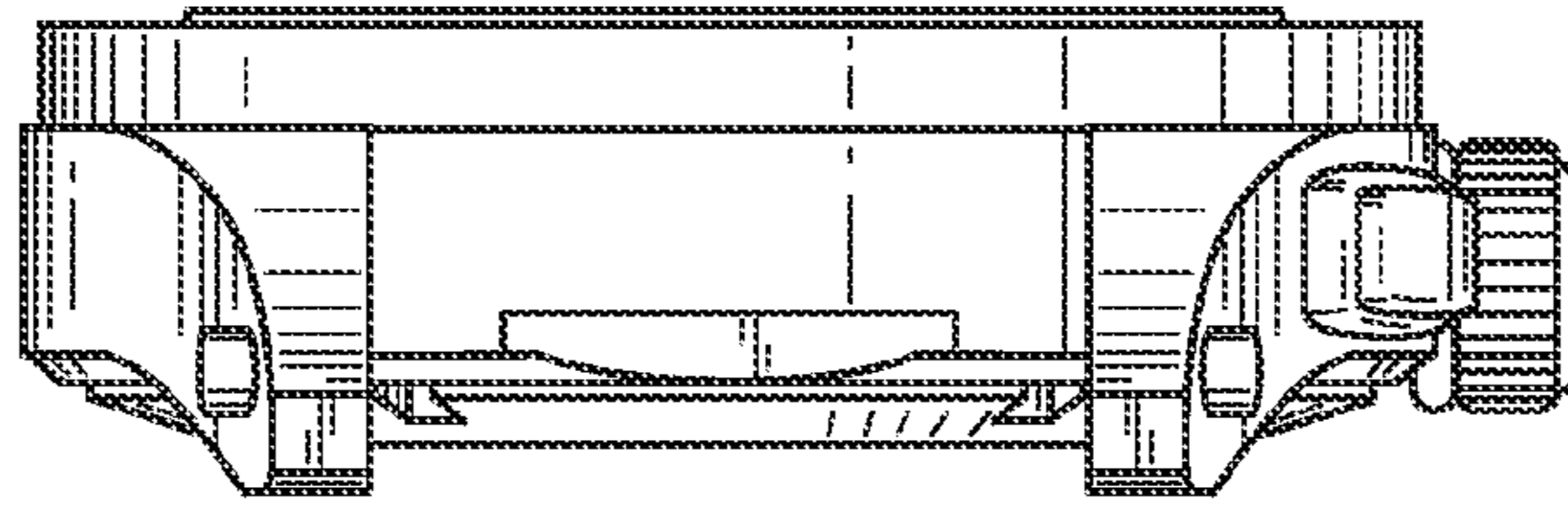

Fig. 4

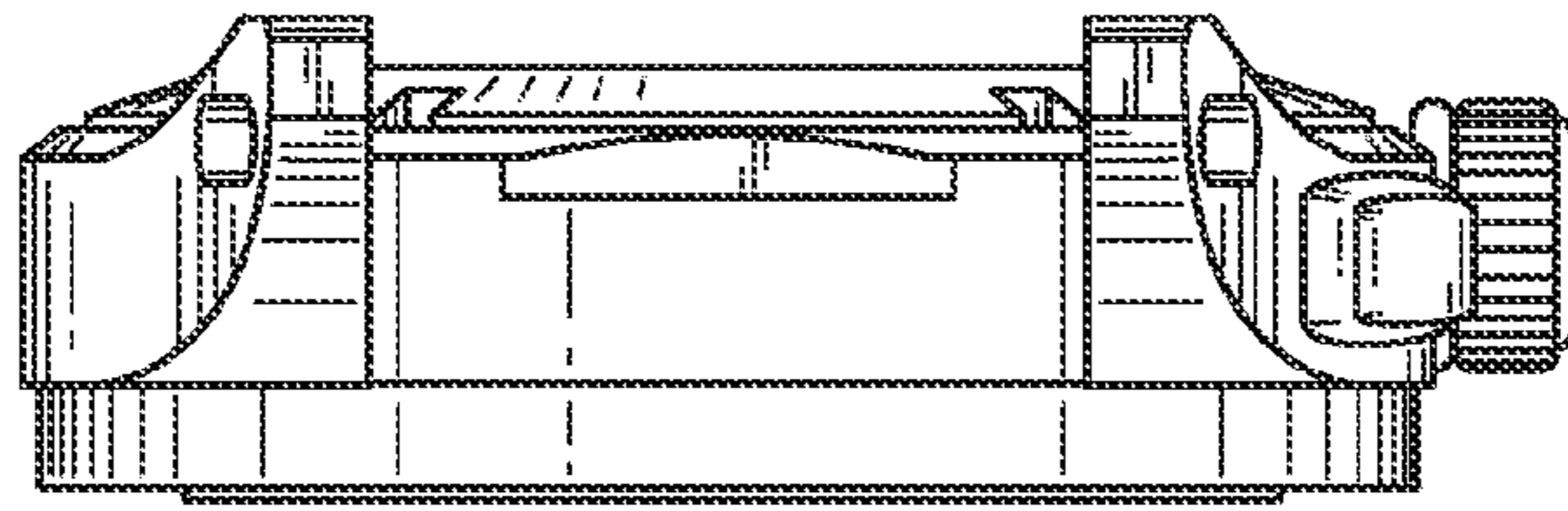

Fig. 5

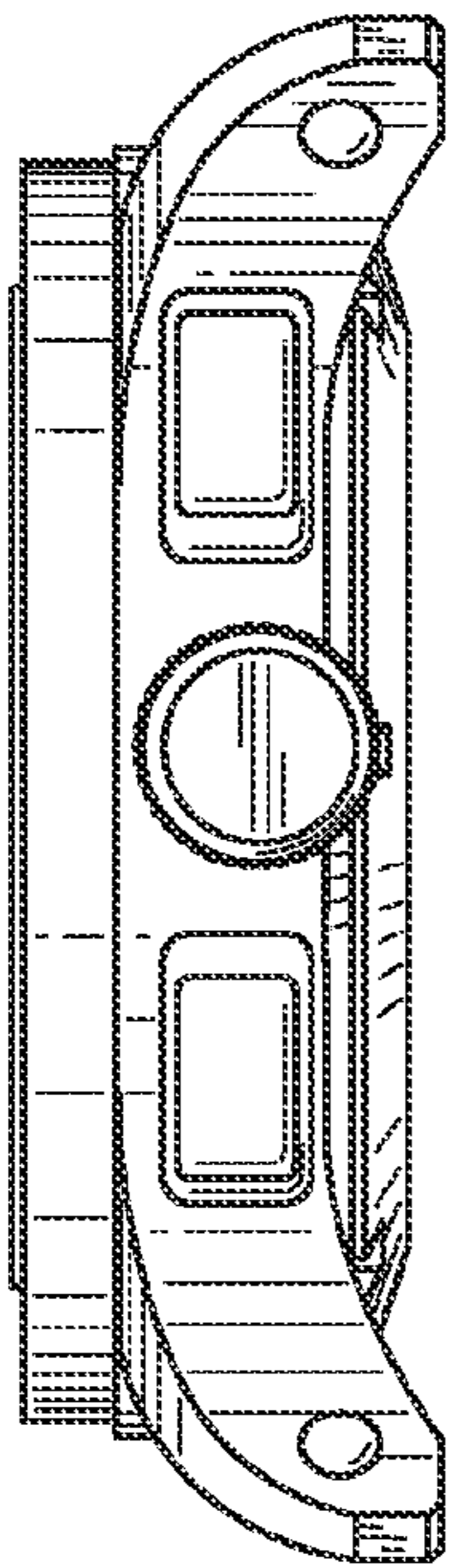

Fig. 6

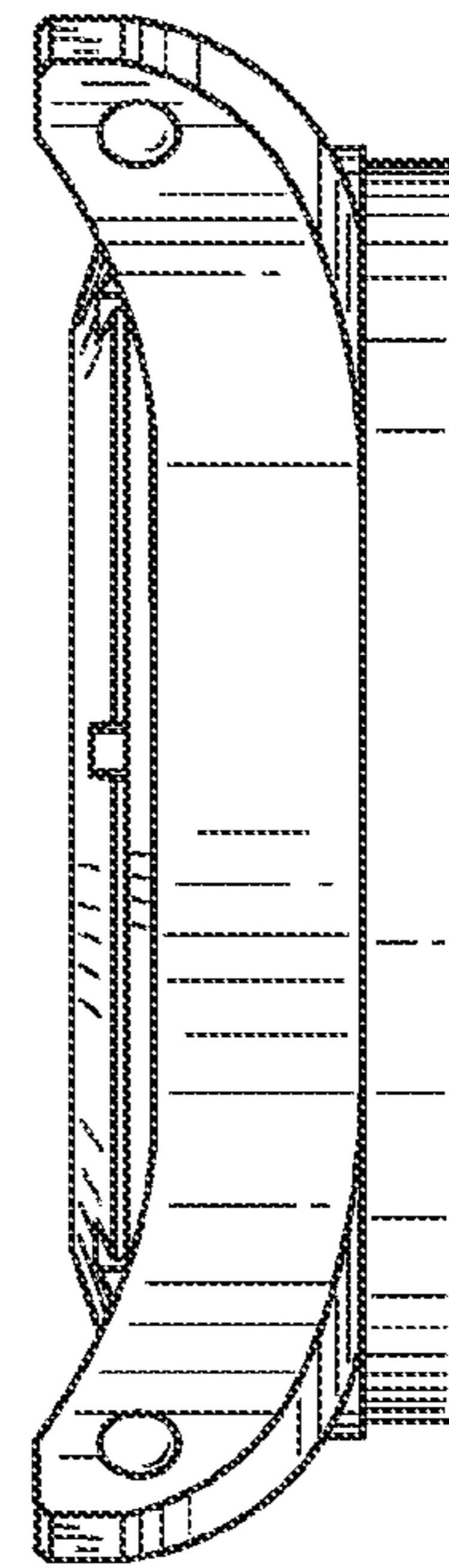

Fig. 7