



US00D590721S

(12) **United States Design Patent**
Martinez De San Vicente

(10) **Patent No.:** **US D590,721 S**

(45) **Date of Patent:** **** Apr. 21, 2009**

(54) **BOTTLE**

(75) **Inventor:** **Luis Oliveras Martinez De San Vicente**, Cornella de Llobregat (ES)

(73) **Assignee:** **Ceras Especiales Martinez de San Vicente, S.A.**, Cornella de Llobregat (ES)

(**) **Term:** **14 Years**

(21) **Appl. No.:** **29/278,587**

(22) **Filed:** **Apr. 3, 2007**

(30) **Foreign Application Priority Data**

Oct. 3, 2006 (EM) 000598669-0001

(51) **LOC (9) Cl.** **09-01**

(52) **U.S. Cl.** **D9/571; D9/520; D9/574**

(58) **Field of Classification Search** D9/516,
D9/520, 529, 560, 571, 574; 215/381-385,
215/379; 220/660, 675

See application file for complete search history.

(56) **References Cited**

U.S. PATENT DOCUMENTS

D306,695 S * 3/1990 Smith D9/563
D395,397 S * 6/1998 Sheffler et al. D9/542
D426,469 S * 6/2000 Mankowski et al. D9/541
D497,553 S * 10/2004 Mitchell D9/545

D523,755 S * 6/2006 Considine et al. D9/560
D537,492 S * 2/2007 Paolucci et al. D21/707
D539,651 S * 4/2007 Snyder D9/520
D540,179 S * 4/2007 Adler et al. D9/563
D548,607 S * 8/2007 Langbein et al. D9/560
D553,994 S * 10/2007 Macak et al. D9/564
D555,498 S * 11/2007 Bansal D9/558
D558,583 S * 1/2008 Langbein et al. D9/560
D574,717 S * 8/2008 Adler et al. D9/563

* cited by examiner

Primary Examiner—Stella M Reid

Assistant Examiner—Elizabeth J Oswecki

(74) *Attorney, Agent, or Firm*—Edell, Shapiro & Finnan, LLC

(57) **CLAIM**

The ornamental design for a bottle, as shown and described.

DESCRIPTION

FIG. 1 is a bottom, right side perspective view of a bottle showing my new design;

FIG. 2 is a top, right side perspective view thereof;

FIG. 3 is a bottom, left side perspective view thereof;

FIG. 4 is a top, left side perspective view thereof;

FIG. 5 is a left side elevation view thereof; and,

FIG. 6 is front elevation view thereof.

1 Claim, 6 Drawing Sheets

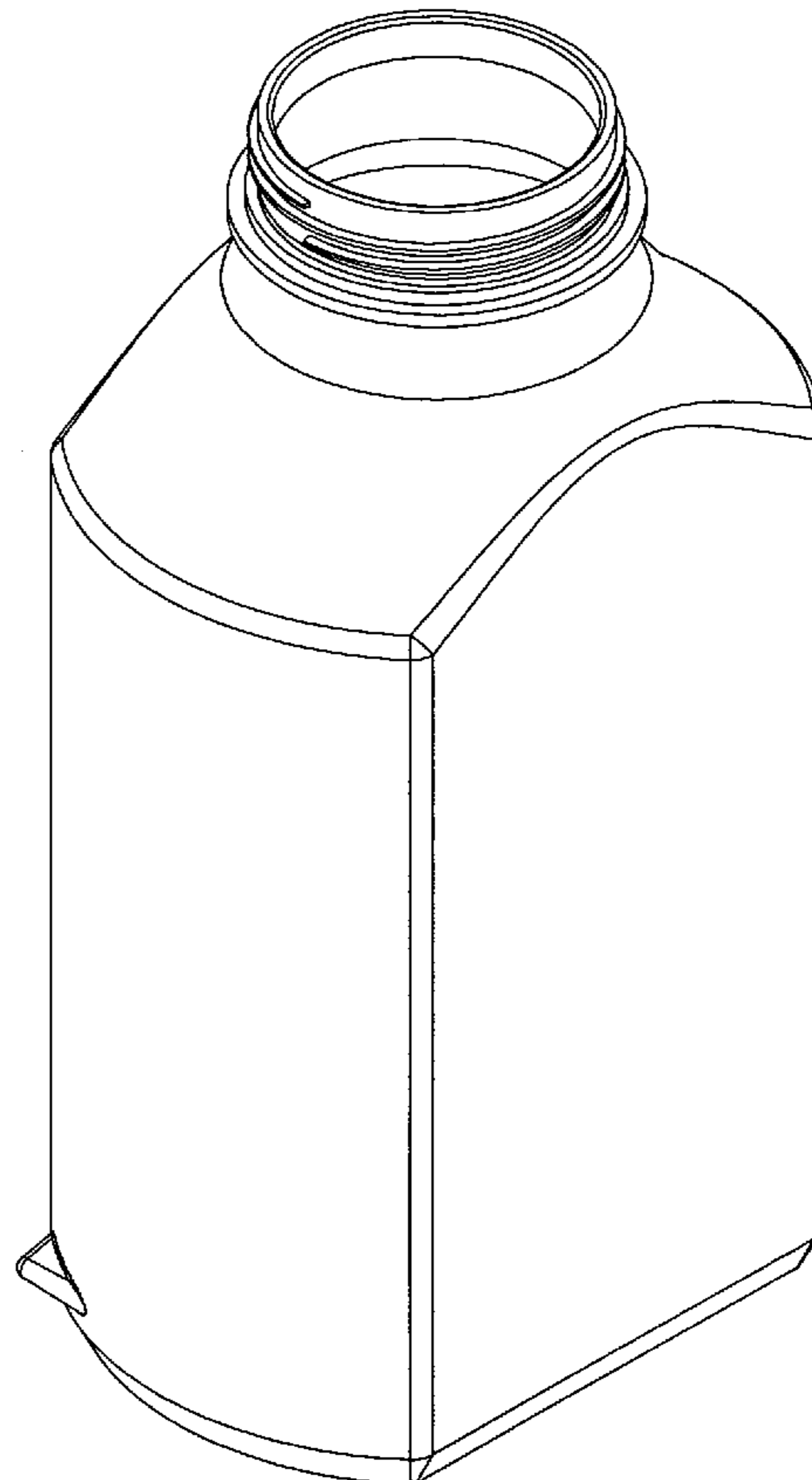
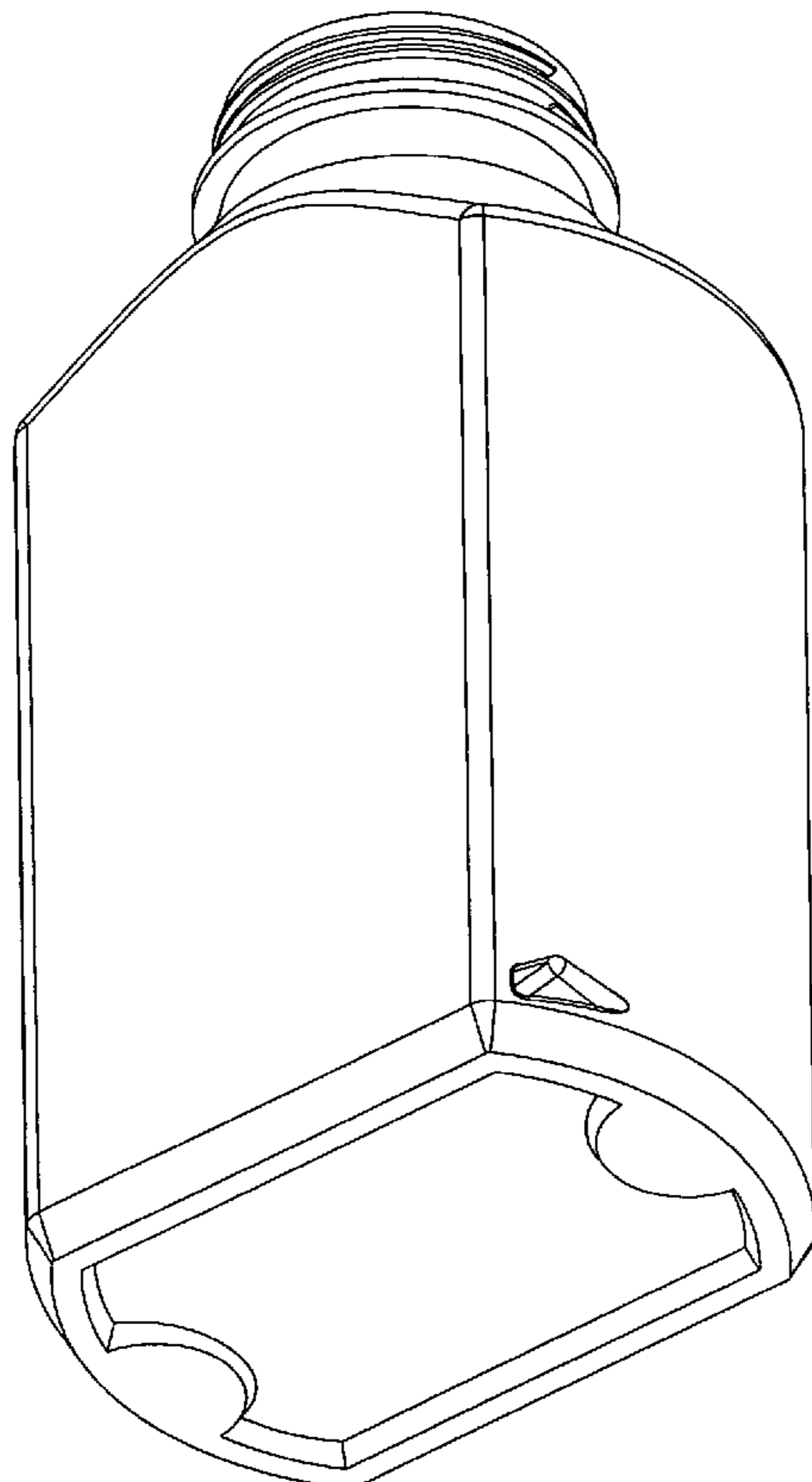

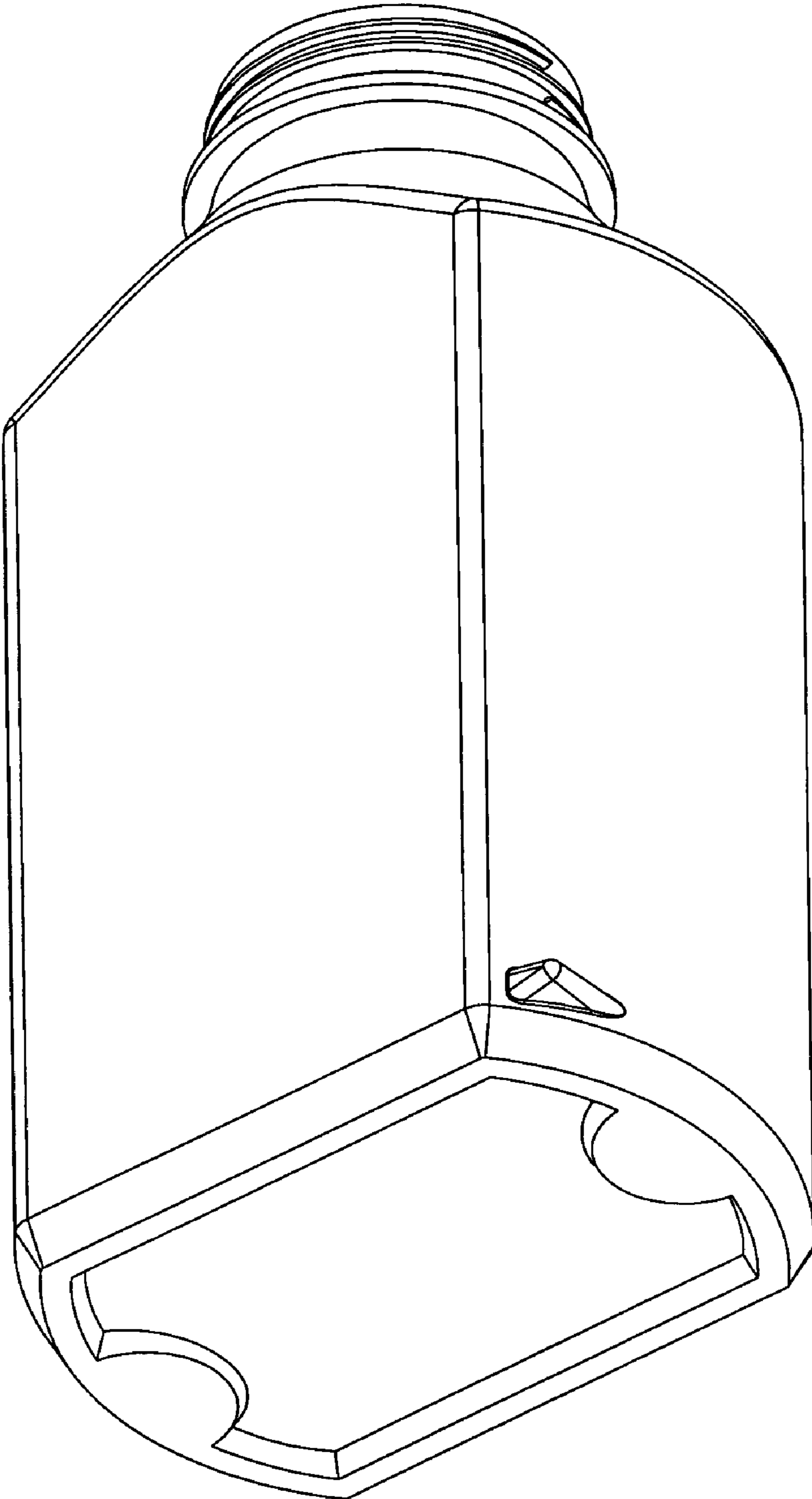

FIG.1

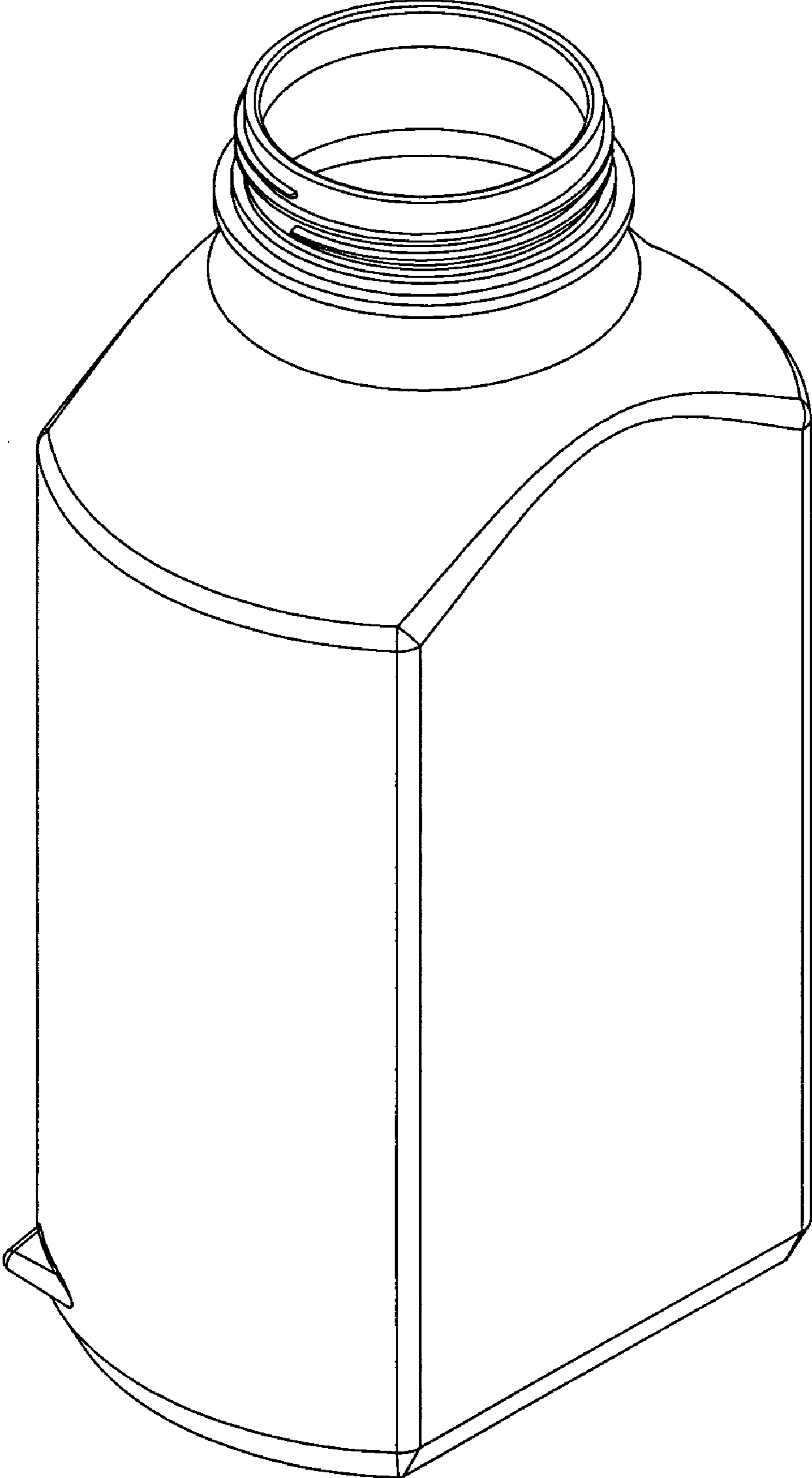

FIG.2

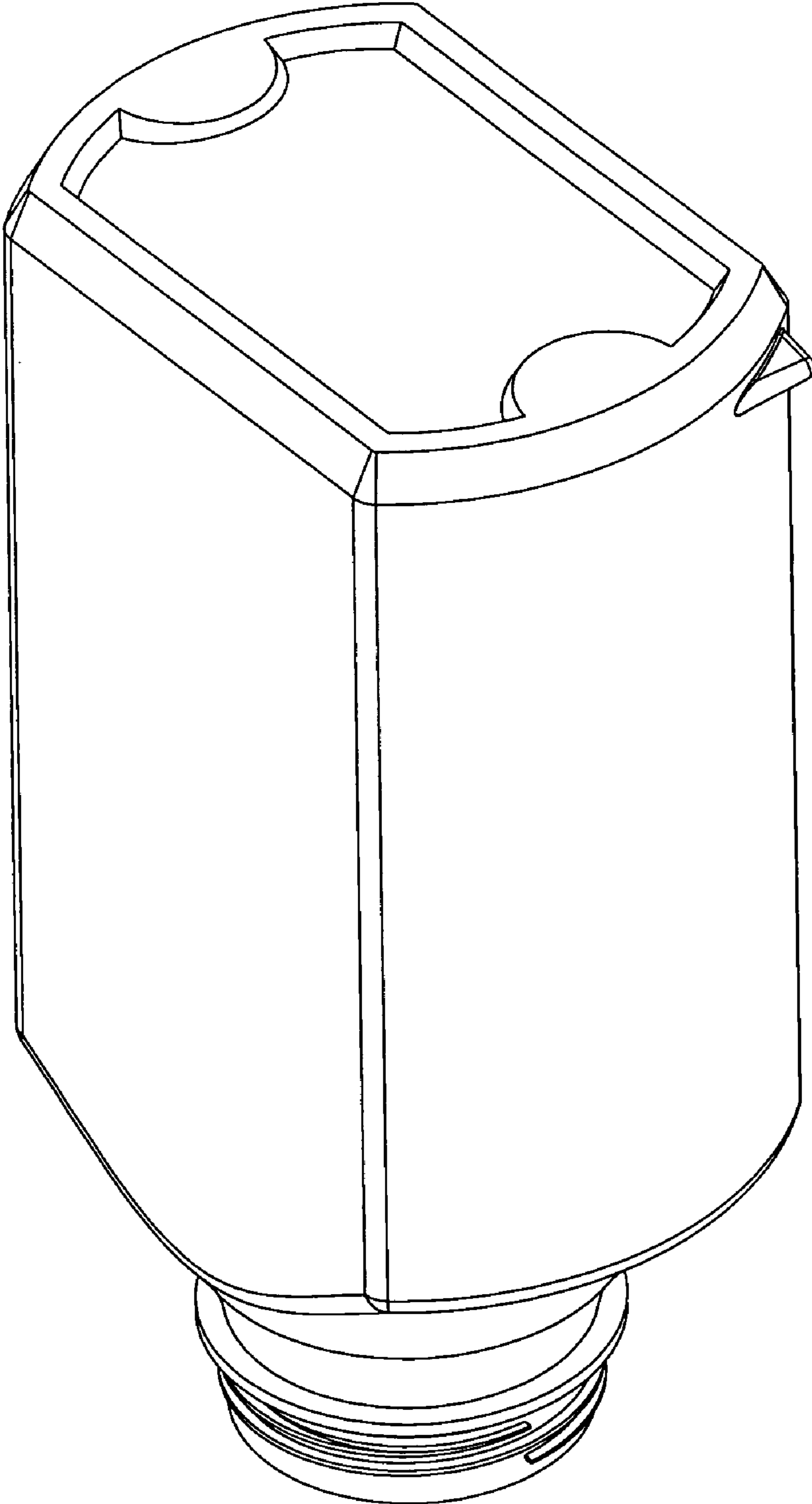

FIG.3

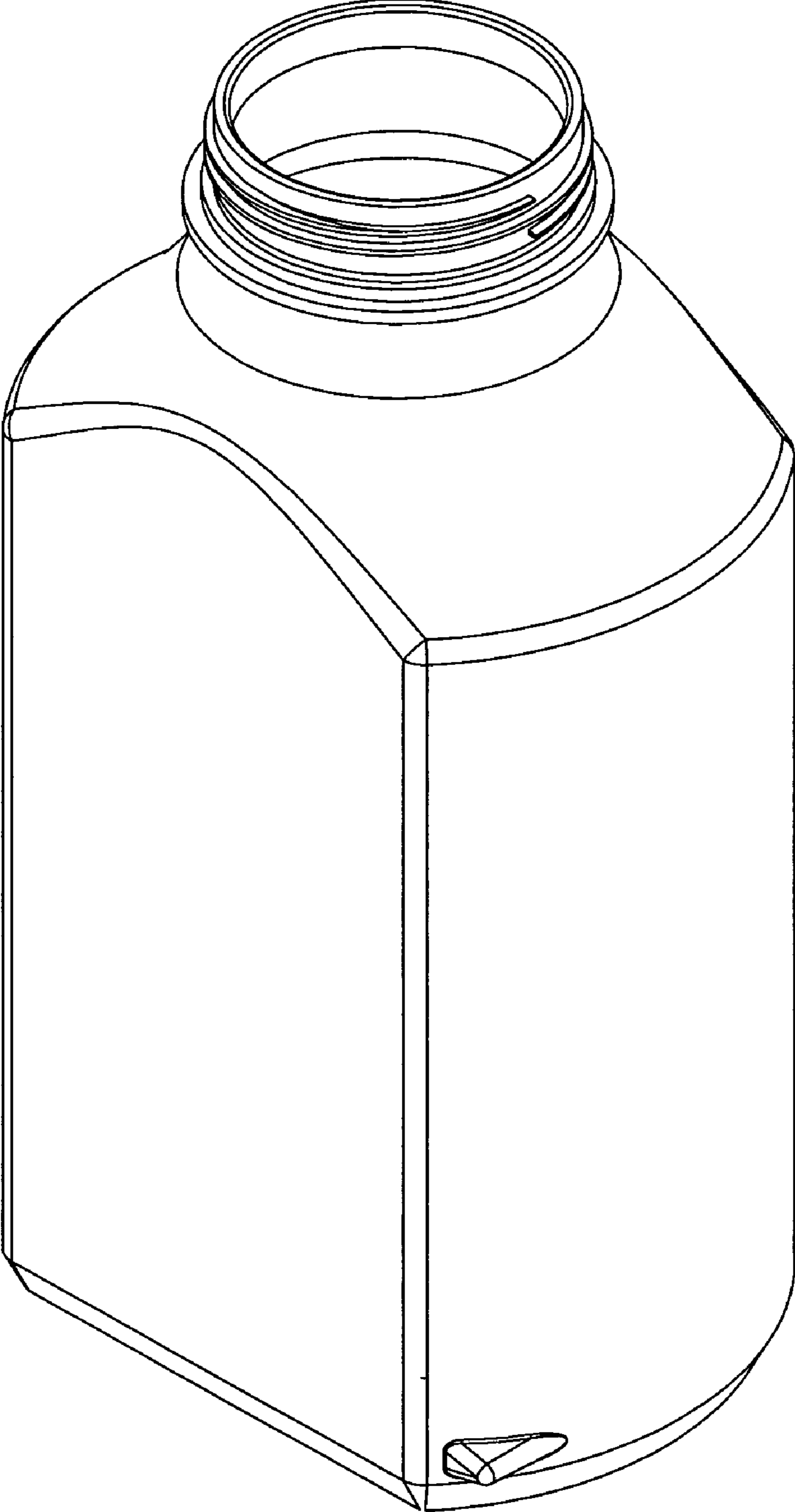

FIG. 4

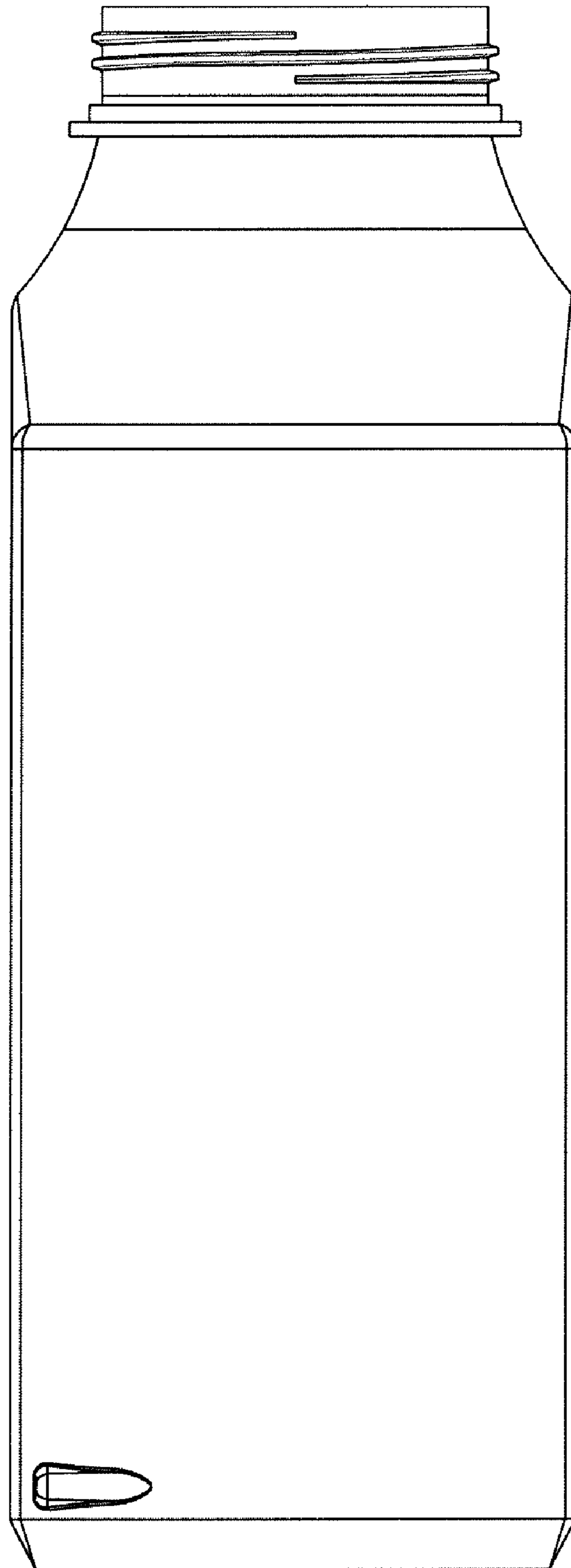

FIG.5

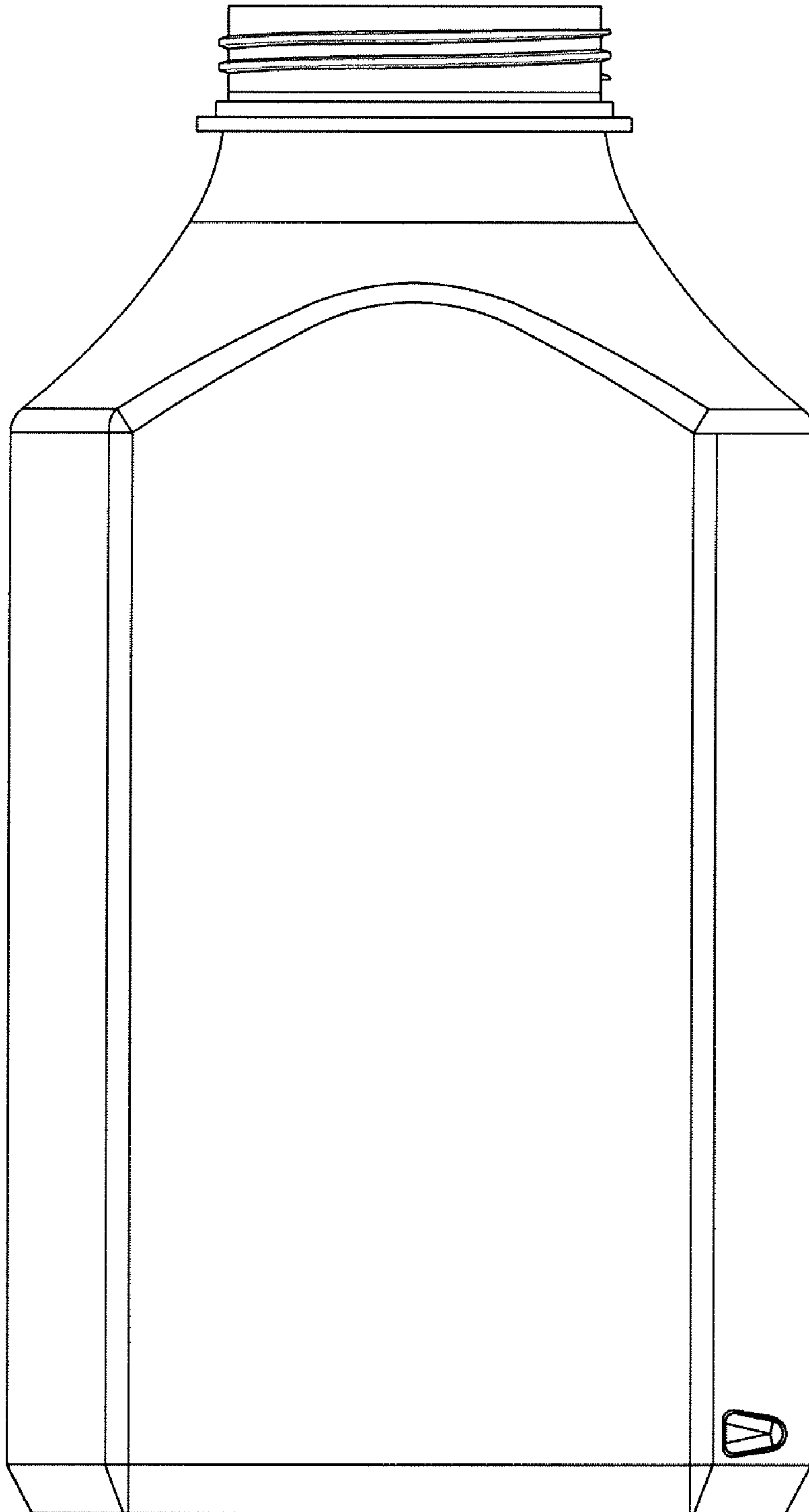

FIG.6