



US00D590686S

(12) **United States Design Patent**
Fukano et al.

(10) **Patent No.:** **US D590,686 S**
(45) **Date of Patent:** **** Apr. 21, 2009**

(54) **ELECTRIC GRIPPER**

(75) Inventors: **Yoshihiro Fukano**, Tsukubamirai (JP);
Shoichi Makado, Tsukubamirai (JP)

(73) Assignee: **SMC Corporation**, Chiyoda-ku, Tokyo
(JP)

(**) Term: **14 Years**

(21) Appl. No.: **29/301,692**

(22) Filed: **Mar. 13, 2008**

(30) **Foreign Application Priority Data**

Sep. 14, 2007 (JP) 2007-025022

(51) **LOC (9) Cl.** **08-05**

(52) **U.S. Cl.** **D8/72**

(58) **Field of Classification Search** D8/71-74,
D8/394, 61; 248/689, 124.2; 81/487, 427,
81/9.3; 269/43, 218, 32-34; D15/140; 294/119.1
See application file for complete search history.

(56) **References Cited**

U.S. PATENT DOCUMENTS

4,607,873	A *	8/1986	Nusbaumer et al.	294/119.1
D438,441	S *	3/2001	Nagai et al.	D8/72
6,309,003	B1 *	10/2001	Bertini	294/119.1
6,505,871	B2 *	1/2003	McCormick	294/119.1
6,938,938	B2 *	9/2005	Risle et al.	294/119.1
2001/0038175	A1 *	11/2001	Nagai et al.	269/32
2002/0084564	A1 *	7/2002	Horn et al.	269/32

2004/0061268	A1 *	4/2004	Sawdon	269/32
2004/0113343	A1 *	6/2004	McIntosh et al.	269/32
2006/0113720	A1 *	6/2006	Ferroud et al.	269/32
2006/0163790	A1 *	7/2006	Xu et al.	269/32
2007/0069439	A1 *	3/2007	McIntosh et al.	269/32

* cited by examiner

Primary Examiner—T. Chase Nelson

Assistant Examiner—David G Muller

(74) *Attorney, Agent, or Firm*—Yokoi & Co., U.S.A., Inc.;
Peter Ganjian

(57) **CLAIM**

The ornamental design for an electric gripper, as shown and described.

DESCRIPTION

FIG. 1 shows a front view of an electric gripper showing my new design;

FIG. 2 shows a rear view thereof;

FIG. 3 shows a top view thereof;

FIG. 4 shows a bottom view thereof;

FIG. 5 shows a left side view thereof;

FIG. 6 shows a right side view thereof; and,

FIG. 7 shows a top, front and left side perspective view thereof.

The broken lines shown in the figures are included for the purpose of illustrating environment only and form no part of the claimed design.

1 Claim, 4 Drawing Sheets

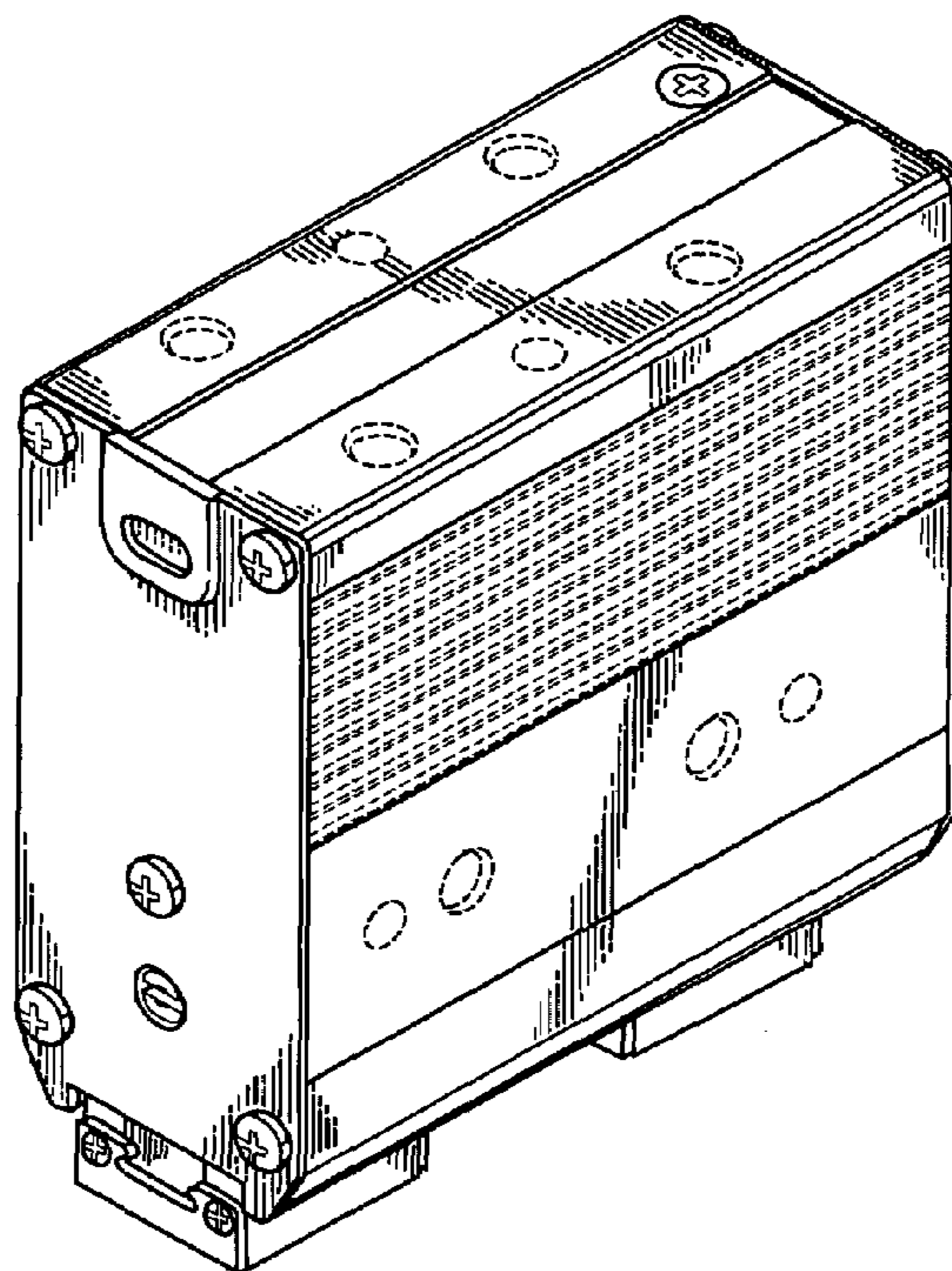

FIG. 1

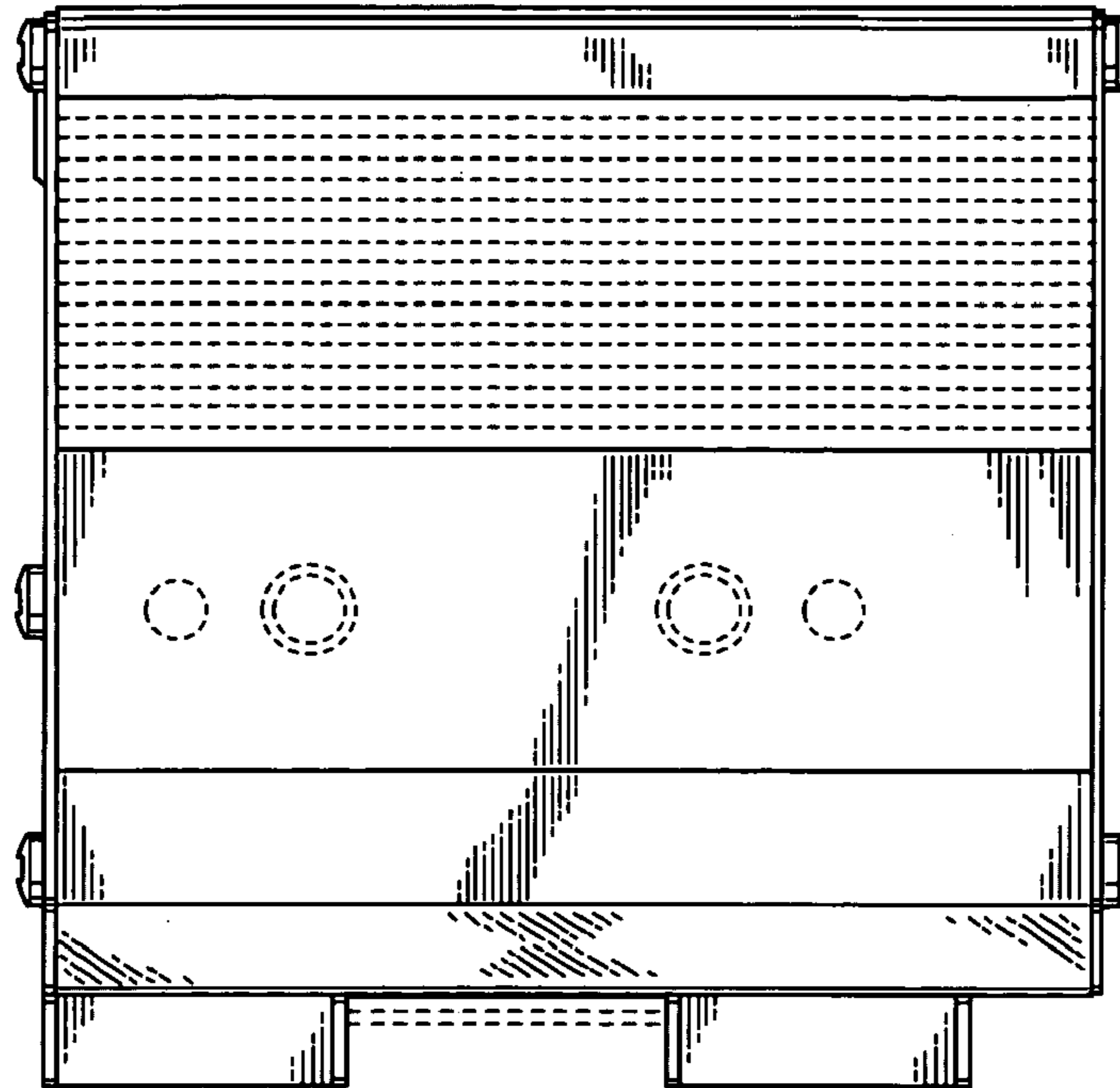

FIG. 2

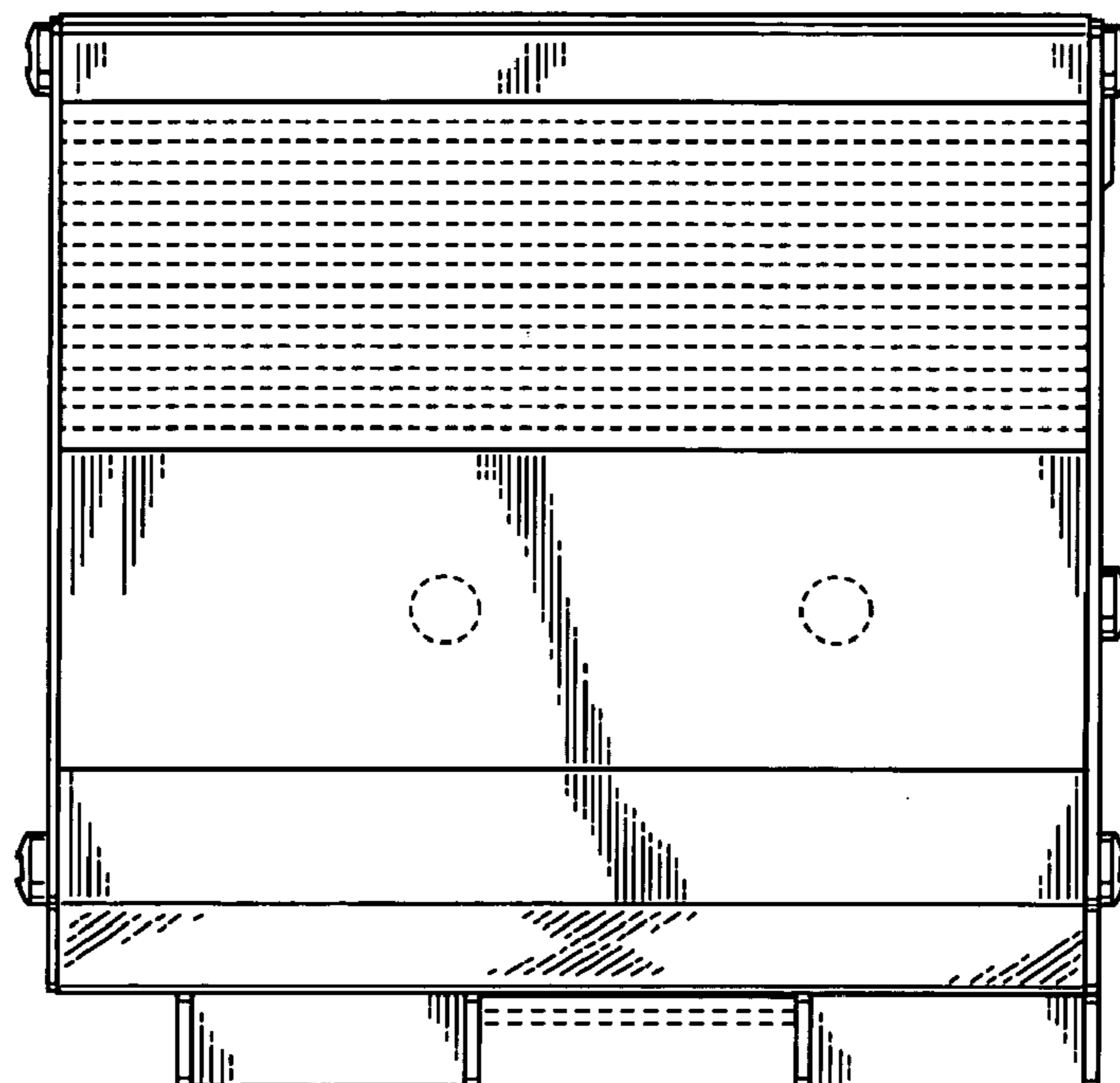

FIG. 3

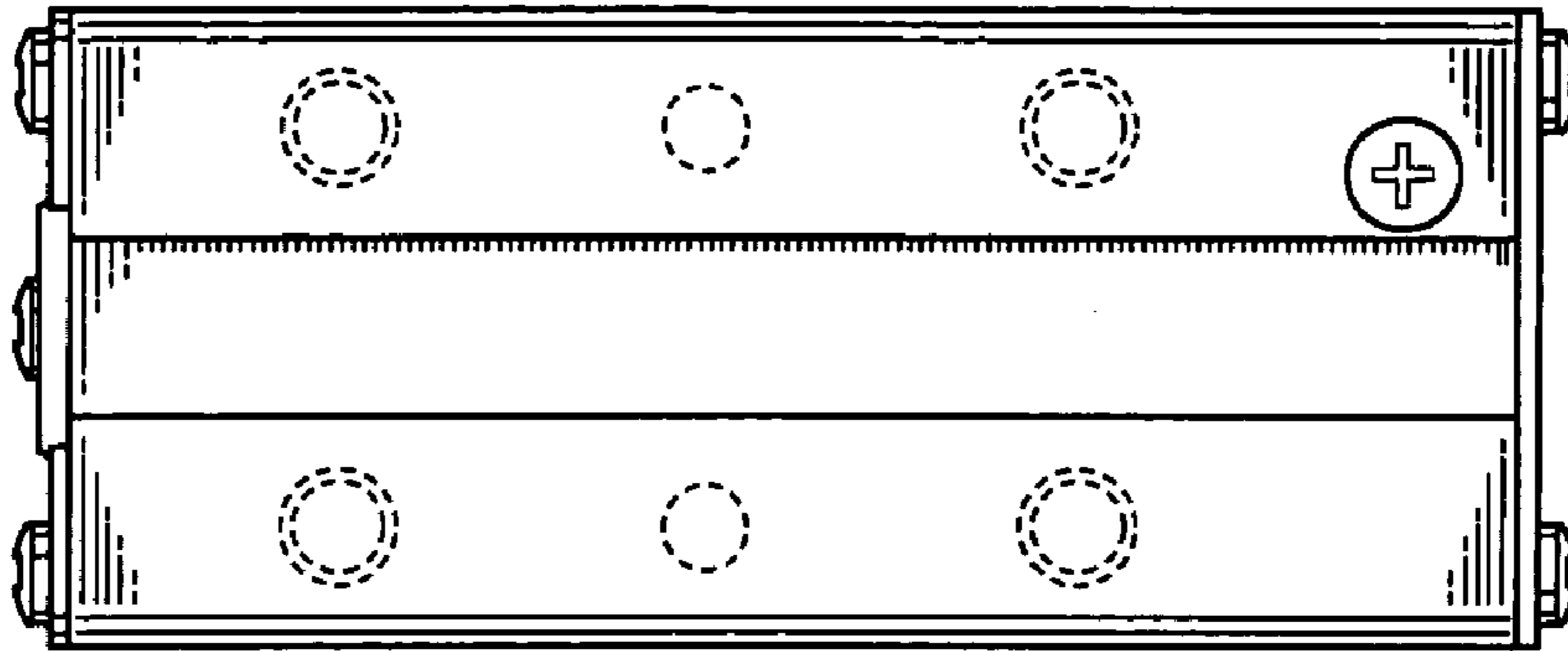

FIG. 4

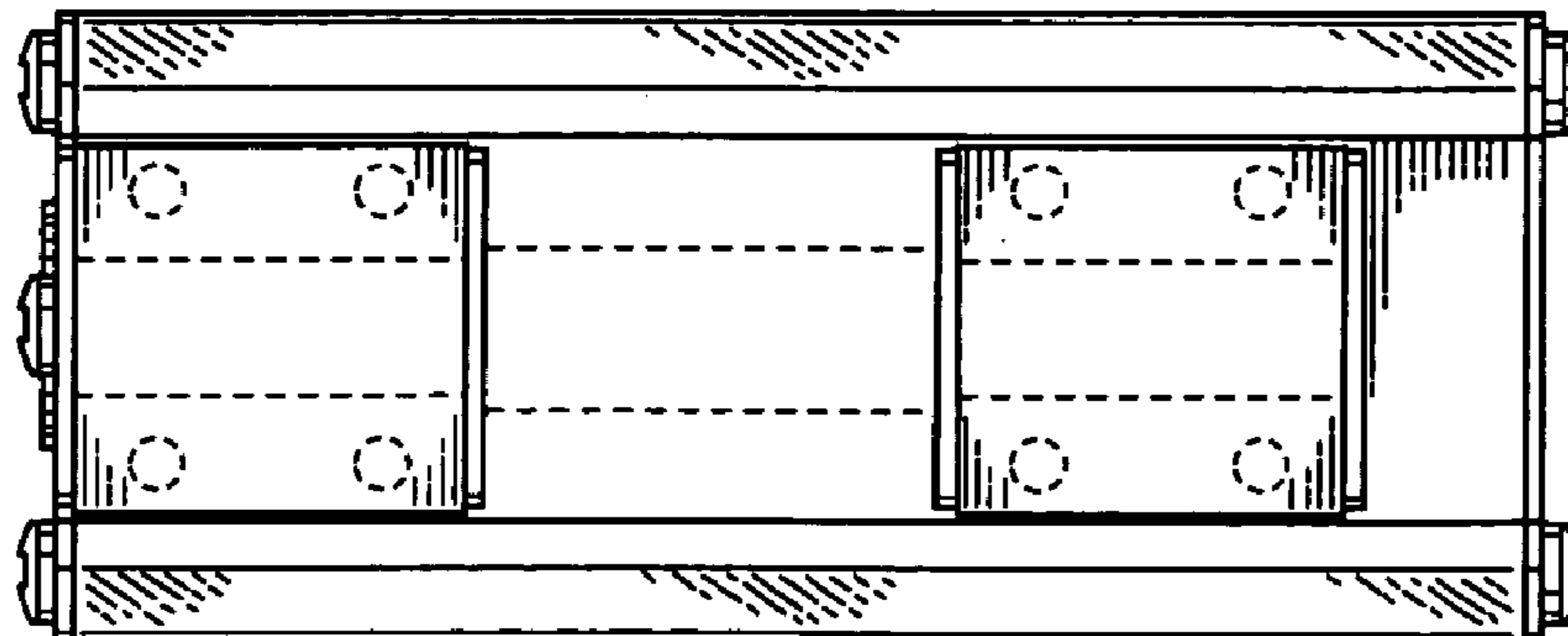

FIG. 5

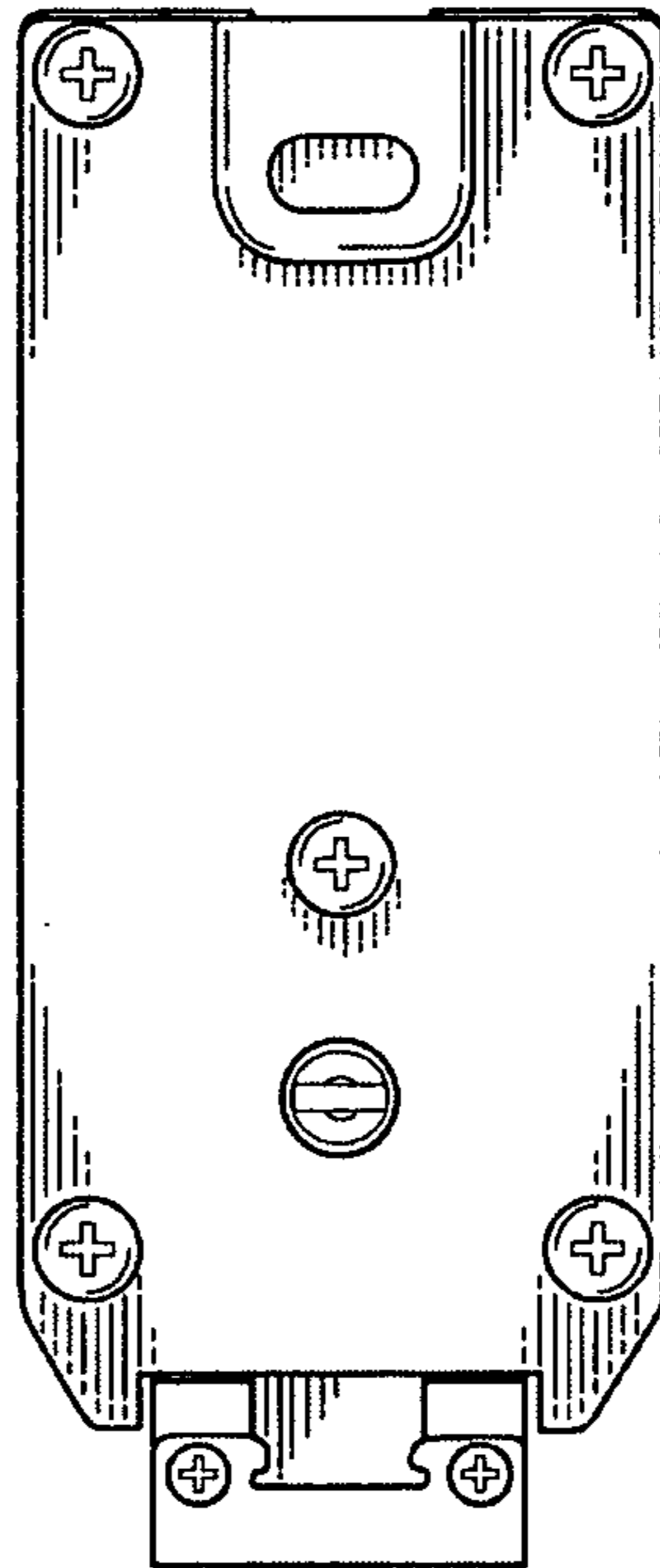

FIG. 6

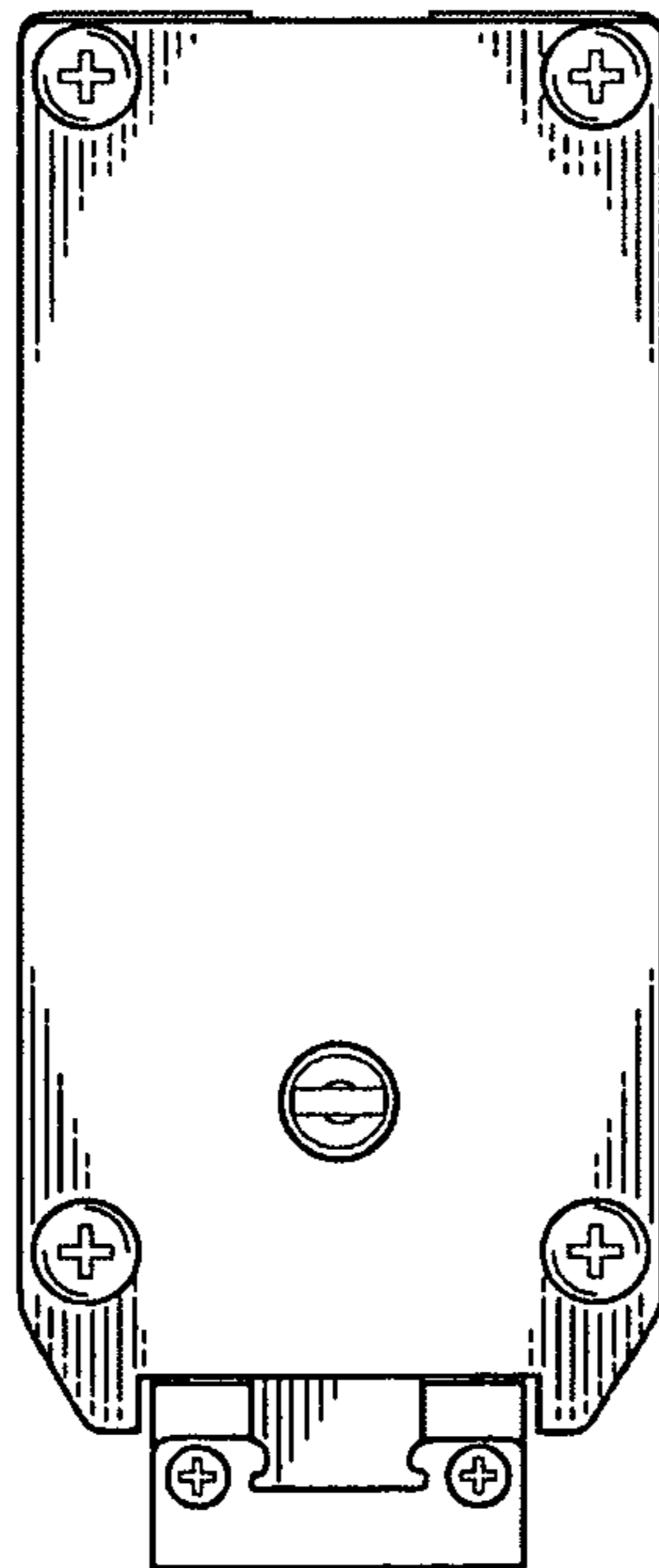

FIG. 7

