



US00D590655S

(12) **United States Design Patent**
Freeman

(10) **Patent No.:** **US D590,655 S**

(45) **Date of Patent:** **** Apr. 21, 2009**

(54) **TWO HANDLED PAN**

(75) Inventor: **Ernest F. Freeman**, Rancho Santa
Margarita, CA (US)

(73) Assignee: **Cambro Manufacturing Company**,
Huntington Beach, CA (US)

(**) Term: **14 Years**

(21) Appl. No.: **29/312,838**

(22) Filed: **Nov. 14, 2008**

(51) **LOC (9) Cl.** **07-02**

(52) **U.S. Cl.** **D7/360; D7/354**

(58) **Field of Classification Search** D3/307;
D7/323, 354-361, 392.1, 390, 396.1, 407,
D7/412, 417, 505, 513, 540-545, 550.1, 551.1,
D7/552.1, 553.1, 553.4-553.8, 554.3, 555,
D7/584, 586, 602, 611, 675, 698; D9/414,
D9/420-434, 446-447, 456, 757; 99/324,
99/339, 422, 426, 446, 448, 450; 220/573.1-573.4,
220/574, 601-602, 610, 657, 669, 672-675,
220/912; 249/66.1, 117, 119, 122-124, 127,
249/155-156, 160
See application file for complete search history.

(56) **References Cited**

U.S. PATENT DOCUMENTS

D395,548 S * 6/1998 Morissette D3/307
D408,222 S * 4/1999 Carter D7/541
D418,017 S * 12/1999 Henry D7/545

D427,009 S * 6/2000 Iyengar et al. D7/360
D434,606 S * 12/2000 Reames et al. D7/552.1
D463,202 S * 9/2002 Smith D7/359
D472,767 S * 4/2003 Gebhardt et al. D7/552.1
D548,004 S * 8/2007 Orr, Jr. D7/390
D549,042 S * 8/2007 Vals et al. D7/359
D575,989 S * 9/2008 McFarland D7/554.3
D582,201 S * 12/2008 Kellermann et al. D7/360

* cited by examiner

Primary Examiner—Caron Veynar

Assistant Examiner—Ricky Pham

(74) *Attorney, Agent, or Firm*—George F. Bethel

(57) **CLAIM**

I claim the ornamental design for a two handled pan, as shown and described.

DESCRIPTION

FIG. 1 is perspective view showing the top, front and right side of the two handled pan.

FIG. 2 is a top plan view.

FIG. 3 is a front elevation view.

FIG. 4 is a side elevation view looking from the right side of FIG. 1.

FIG. 5 is a side elevation view looking from the left side of FIG. 1.

FIG. 6 is a back elevation view; and,

FIG. 7 is a bottom plan view.

1 Claim, 5 Drawing Sheets

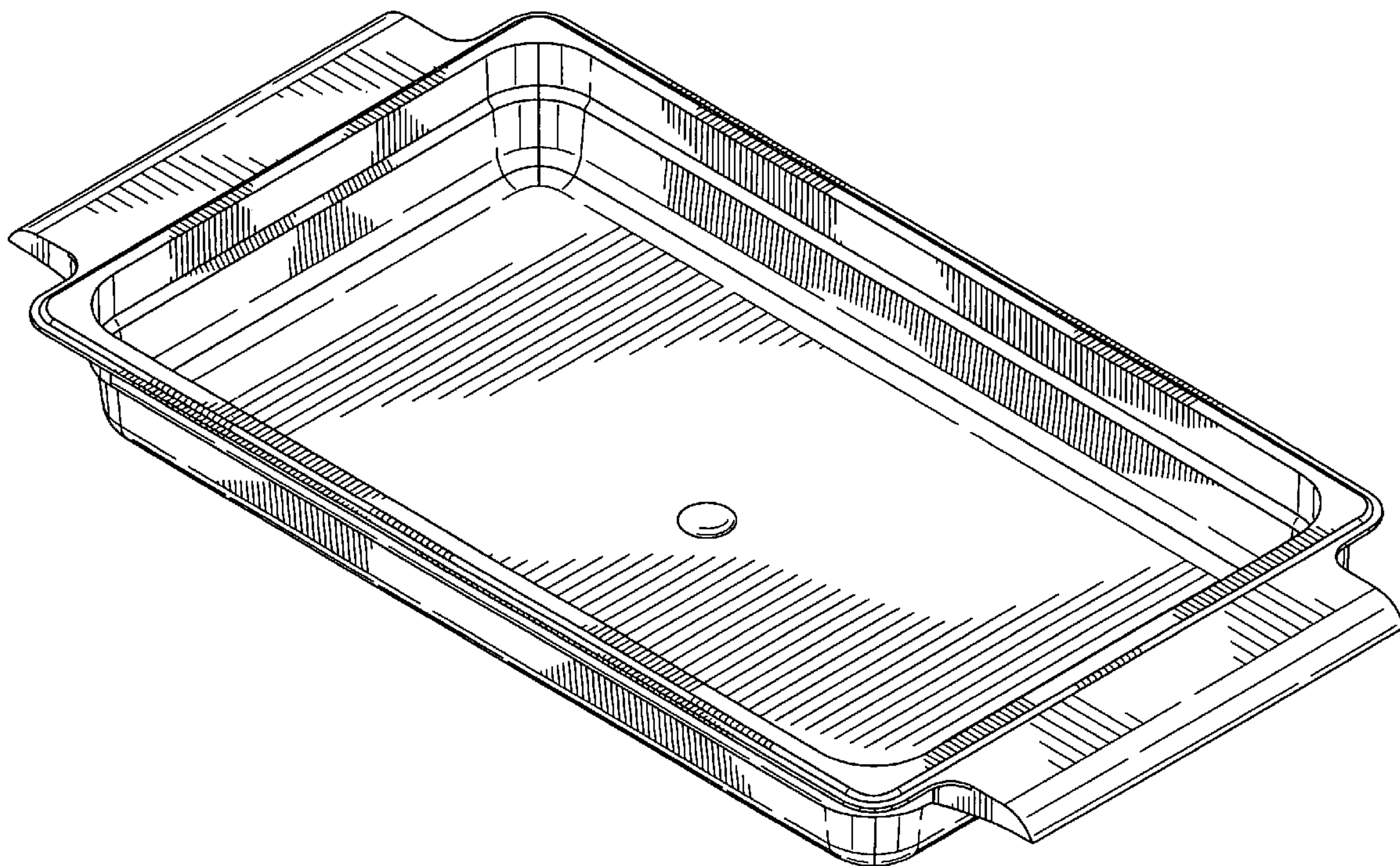
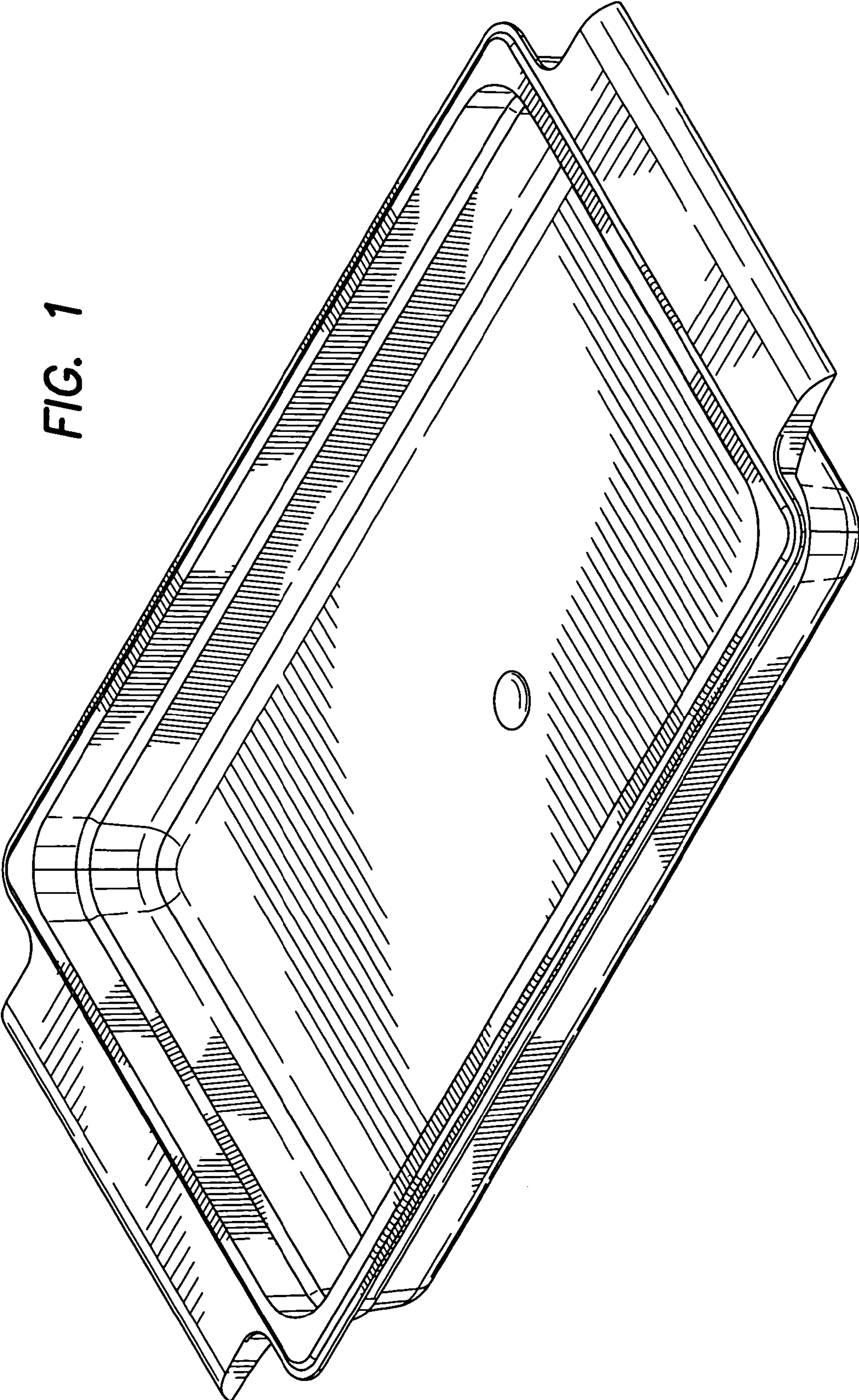

FIG. 1



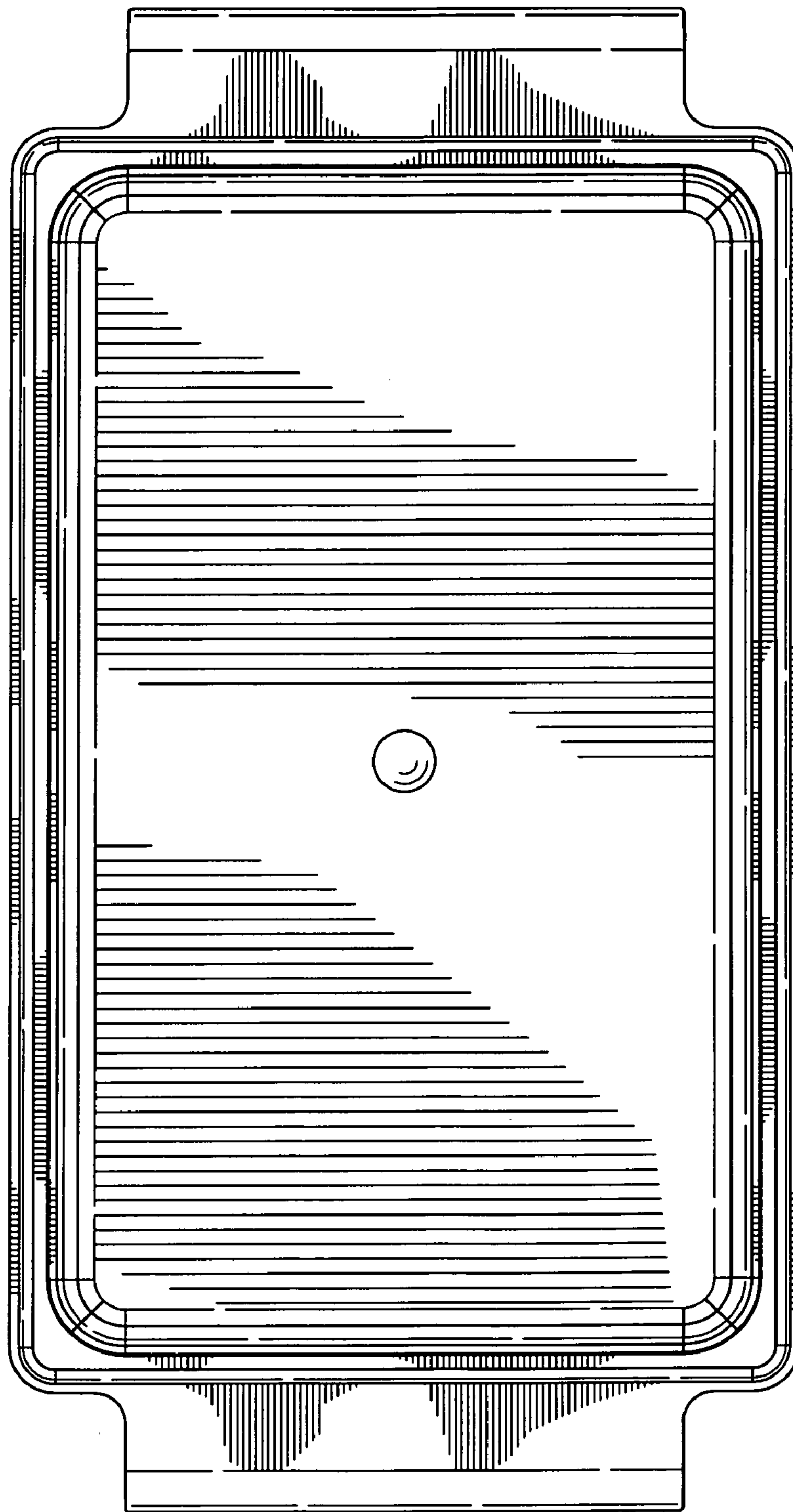

FIG. 2

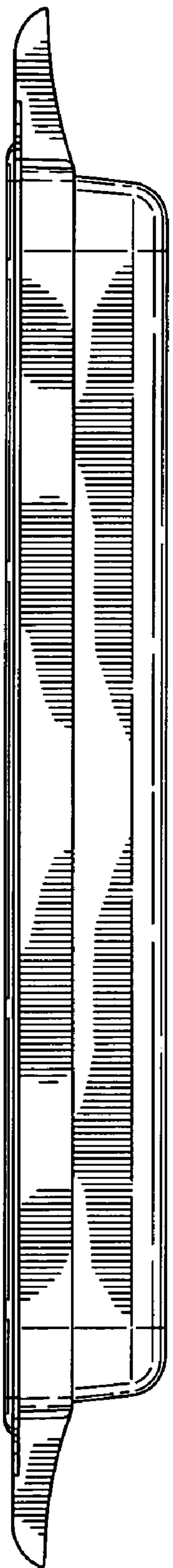

FIG. 3

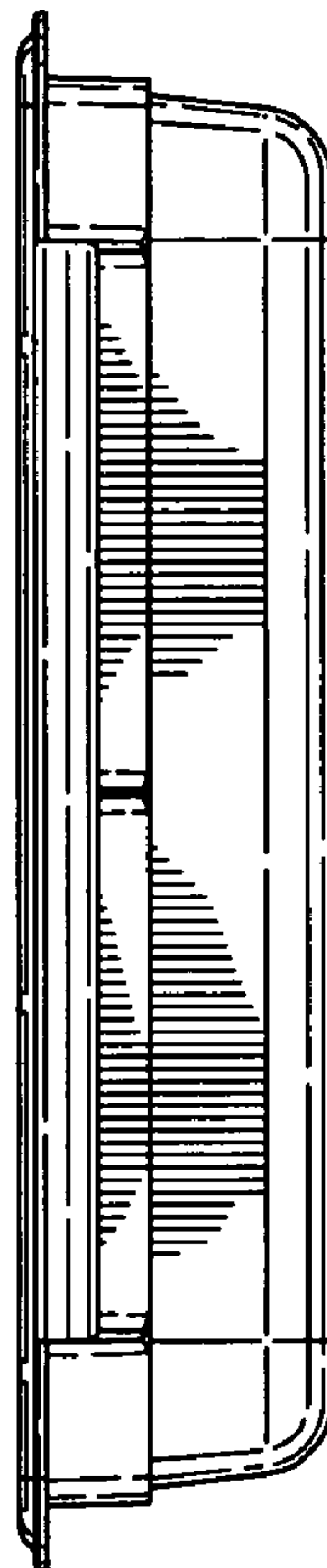

FIG. 4

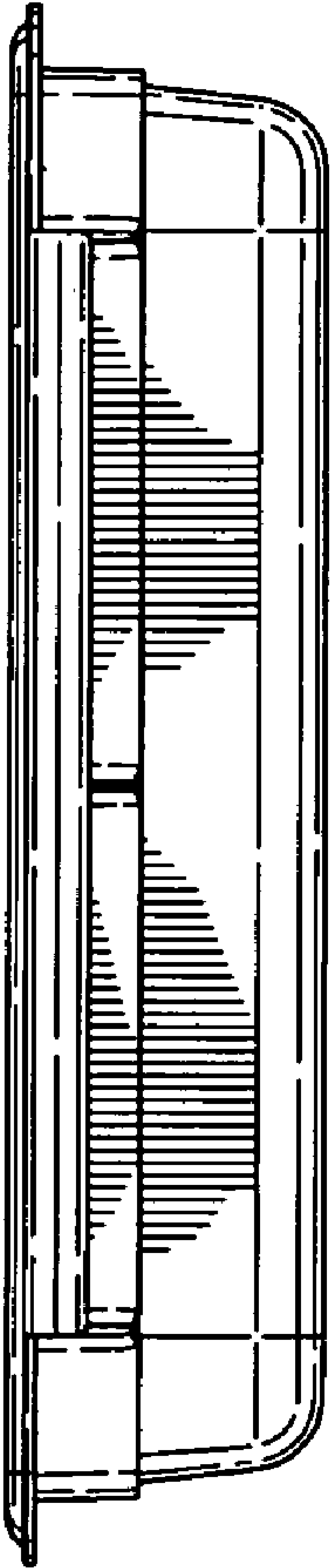

FIG. 5

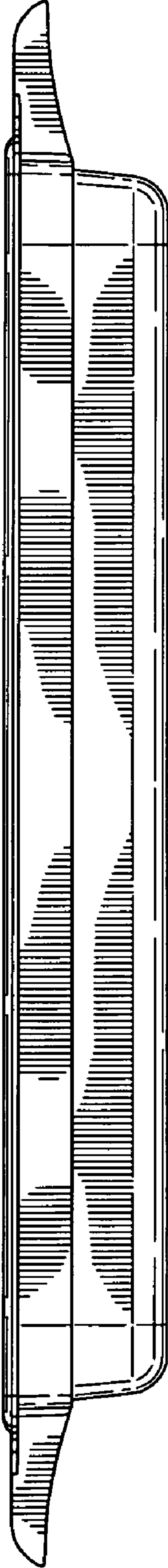

FIG. 6

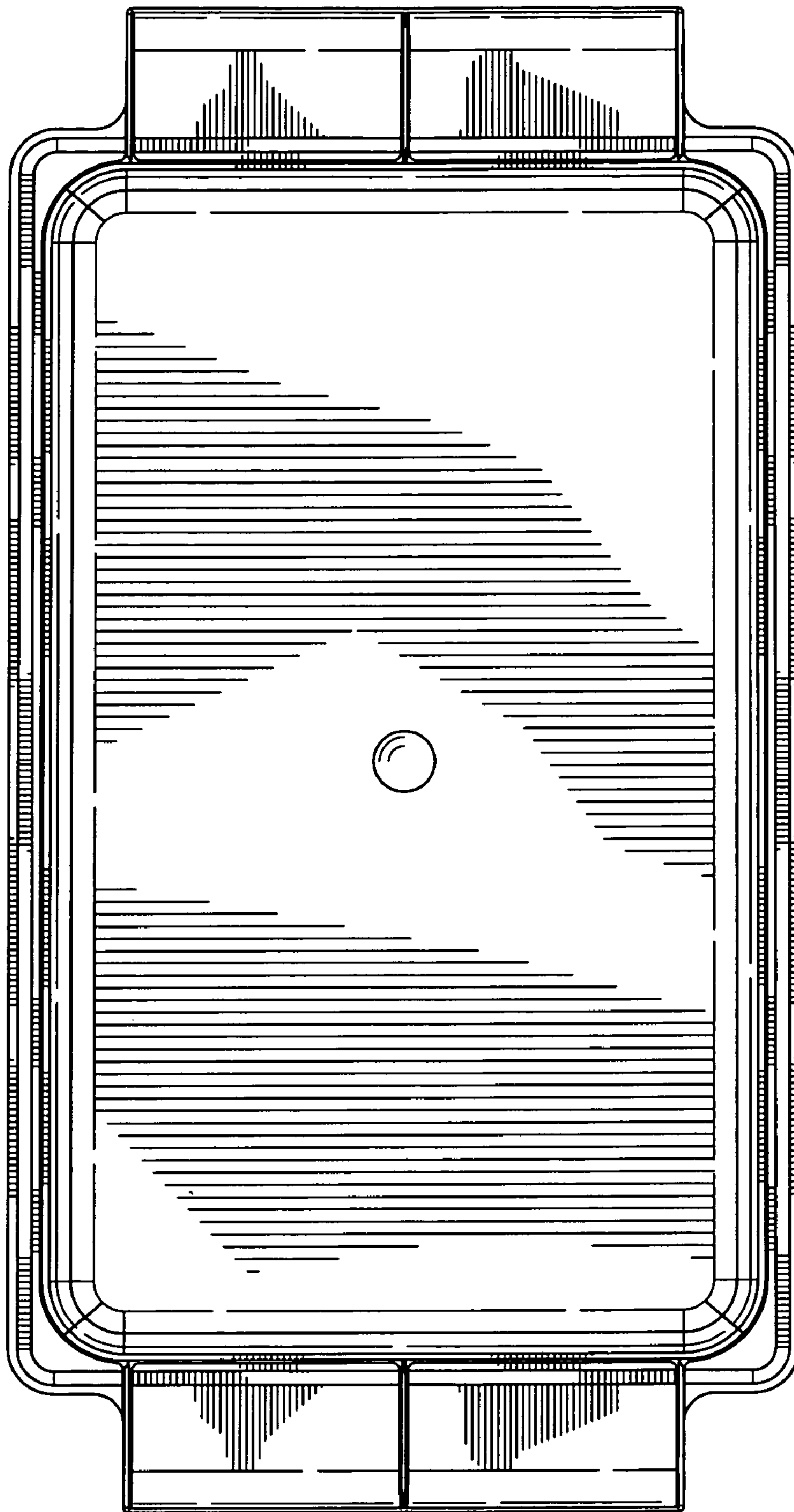

FIG. 7