



US00D590599S

(12) **United States Design Patent**
Nanda

(10) **Patent No.:** **US D590,599 S**
(45) **Date of Patent:** **** Apr. 21, 2009**

(54) **TOOTHBRUSH**

2007/0039109 A1 2/2007 Nanda
2007/0131241 A1 6/2007 Nanda

(75) Inventor: **Puneet Nanda**, Cerritos, CA (US)

* cited by examiner

(73) Assignee: **Dr. Fresh, Inc.**, Buena Park, CA (US)

Primary Examiner—Cathron C Brooks

Assistant Examiner—Lavone D Tabor

(**) Term: **14 Years**

(74) *Attorney, Agent, or Firm*—Knobbe Martens Olson & Bear, LLP

(21) Appl. No.: **29/306,294**

(22) Filed: **Apr. 4, 2008**

(57) **CLAIM**

(51) **LOC (9) Cl.** **04-02**

The ornamental design for a toothbrush, as shown and described.

(52) **U.S. Cl.** **D4/112**

(58) **Field of Classification Search** D4/104-112,
D4/132, 134, 138; 15/143.1, 167.1, 167.2;
132/308-311

DESCRIPTION

See application file for complete search history.

FIG. 1 is a bottom, front, and right side perspective of a toothbrush embodying my new design.

FIG. 2 is a front elevation view of FIG. 1.

FIG. 3 is a rear elevation view of FIG. 1.

FIG. 4 is a right side view of FIG. 1.

FIG. 5 left side view of FIG. 1.

FIG. 6 is a top plan view of FIG. 1; and,

FIG. 7 is a bottom plan view of FIG. 1.

The broken lines immediately adjacent the surface shading on the free end of the handle represents the bounds of the claim and the rest of the broken lines showing the bottom of the handle and bristles illustrate portions of the article none of which form part of the claimed design.

(56) **References Cited**

U.S. PATENT DOCUMENTS

D29,219 S *	8/1898	Ufford	D4/112
D199,236 S *	9/1964	Phaneuf	D4/104
D219,256 S *	11/1970	Dick	D4/104
D458,454 S	6/2002	Nanda		
D458,758 S	6/2002	Nanda		
D478,426 S *	8/2003	Xi	D4/104
D490,247 S	5/2004	Nanda		
D492,116 S	6/2004	Nanda		
D501,322 S *	2/2005	Fishman	D4/112
D505,015 S	5/2005	Nanda		
7,201,172 B2	4/2007	Nanda		
2006/0174431 A1	8/2006	Nanda		

1 Claim, 4 Drawing Sheets

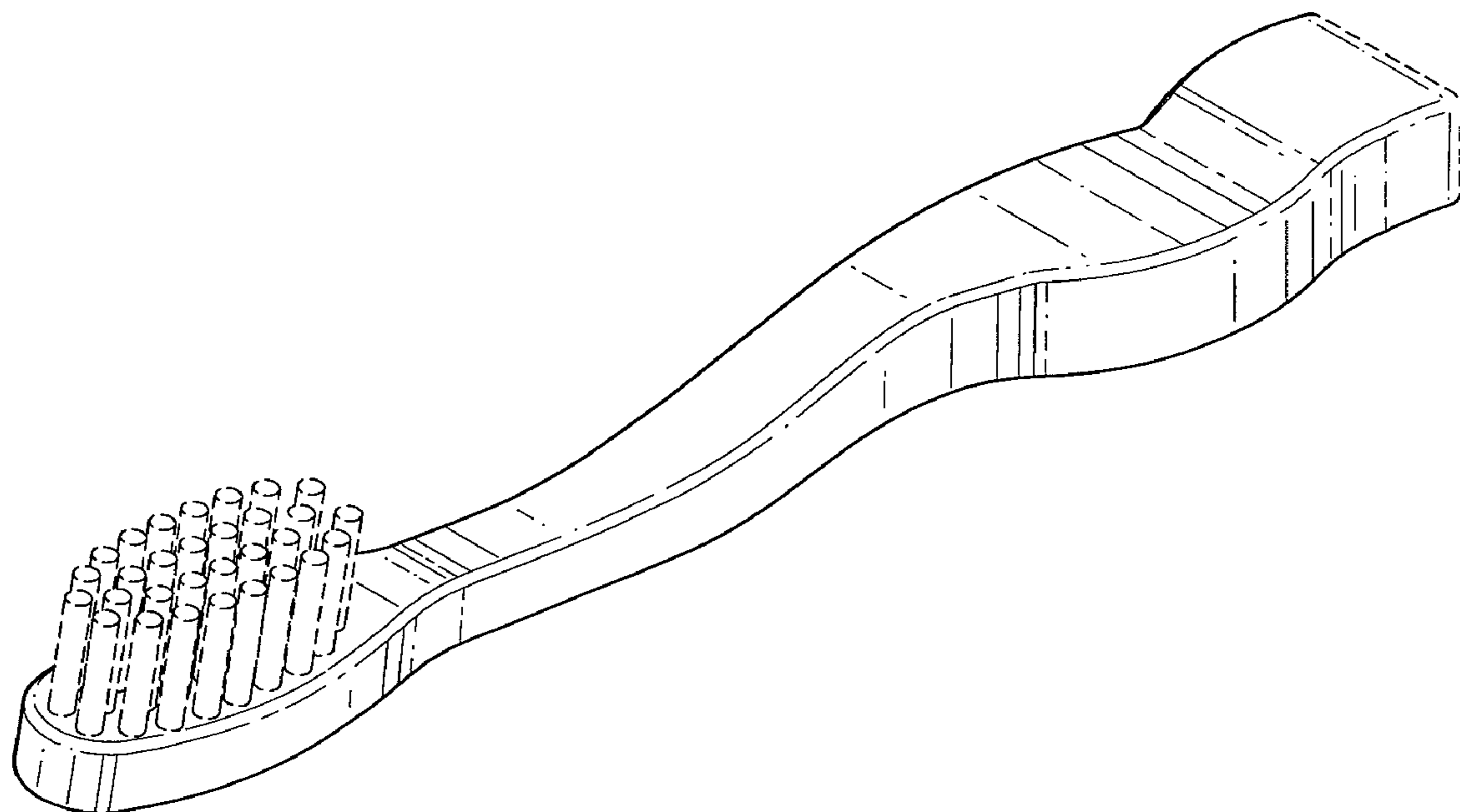

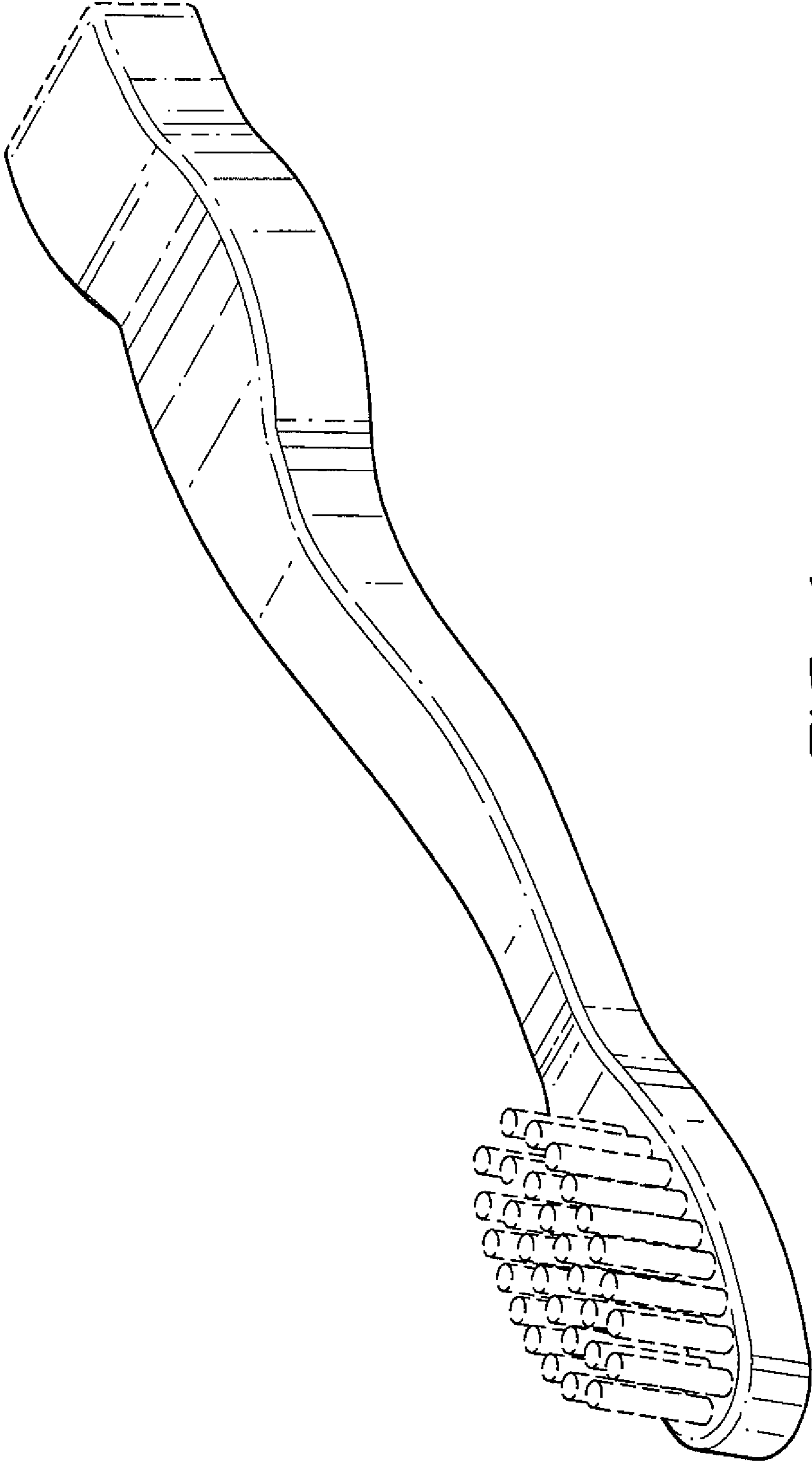

FIG. 1

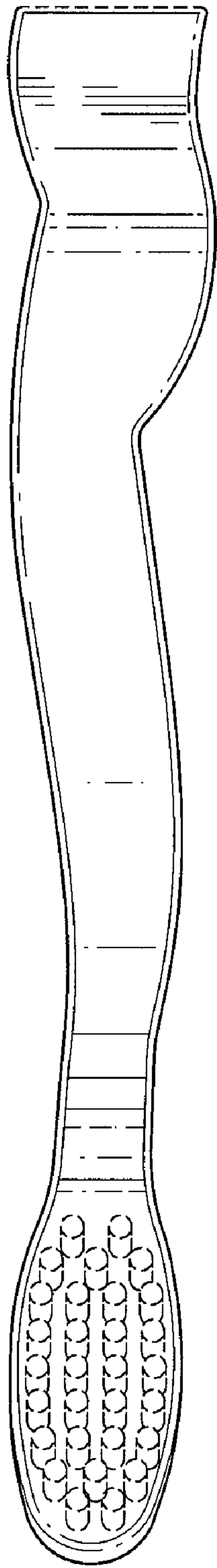

FIG. 2

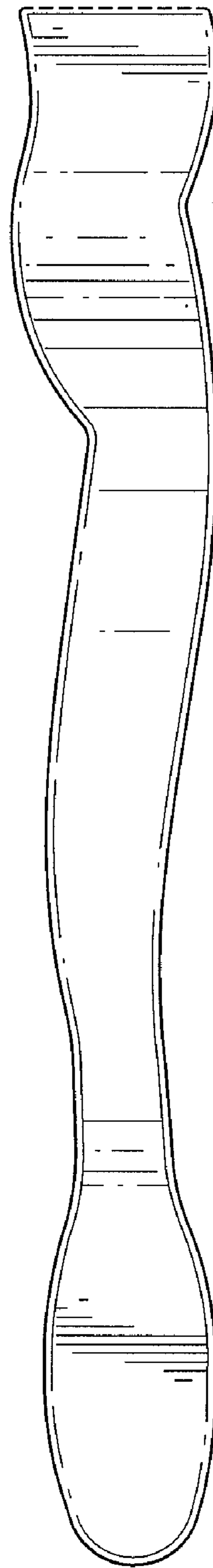

FIG. 3

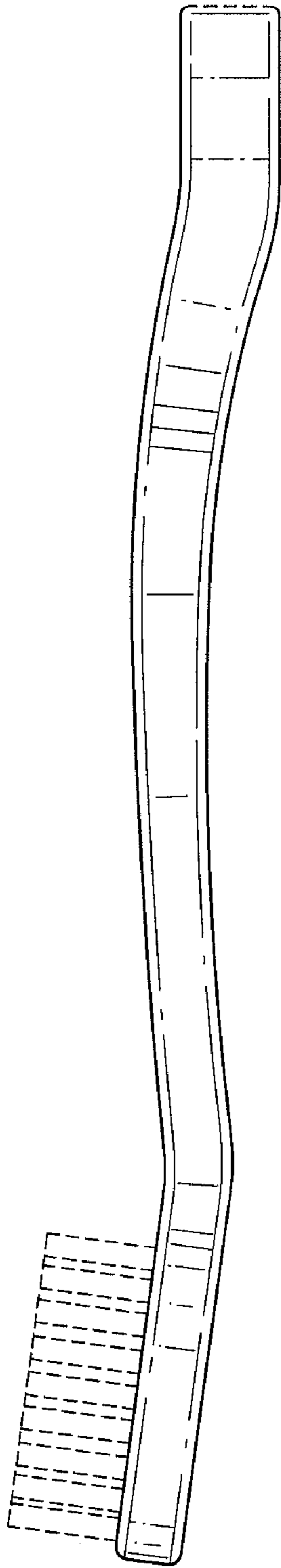

FIG. 4

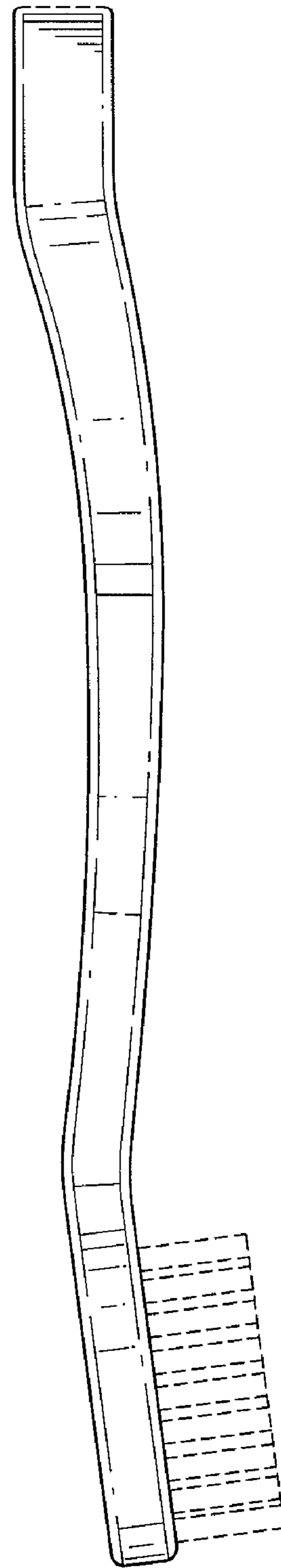

FIG. 5

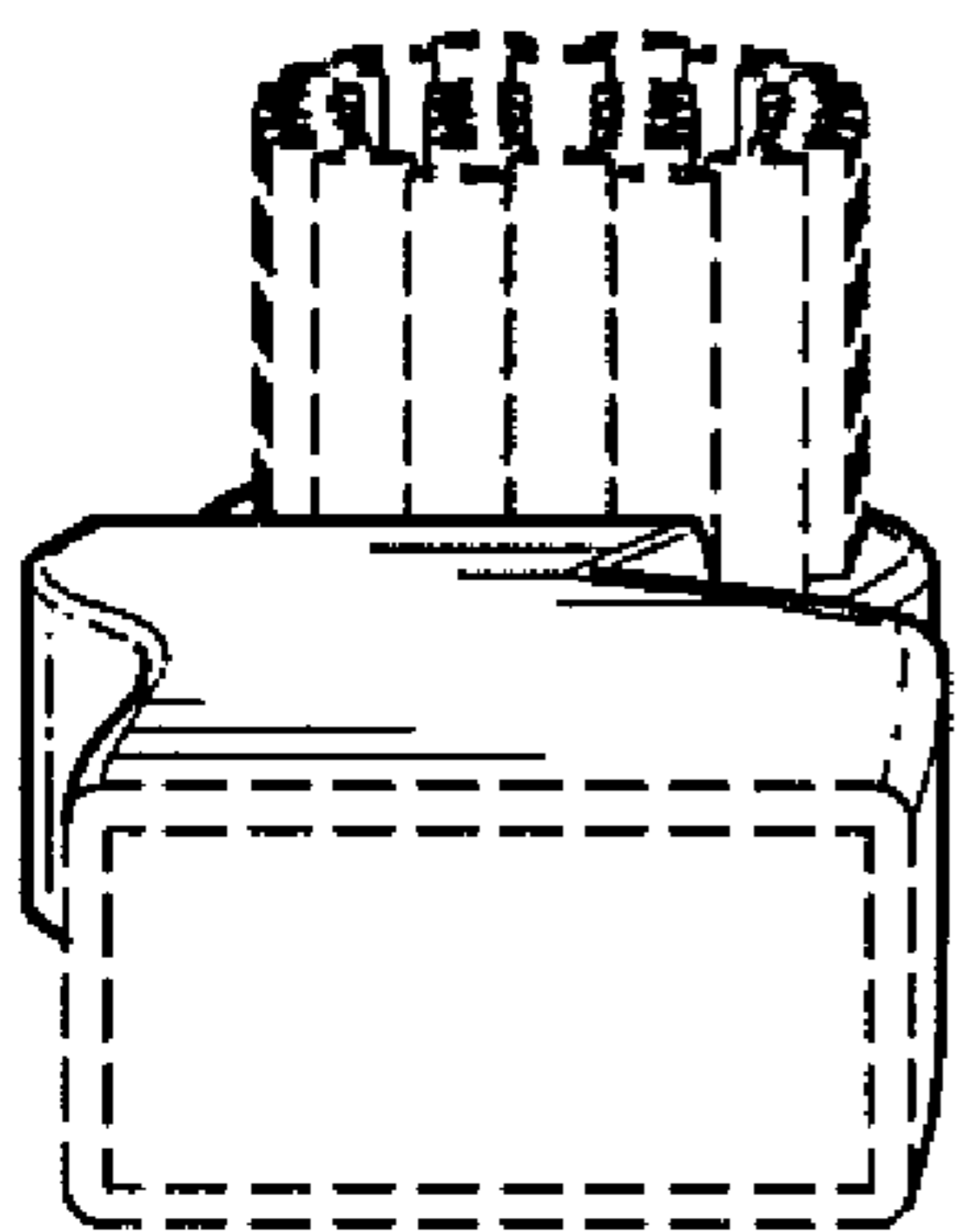

FIG. 6

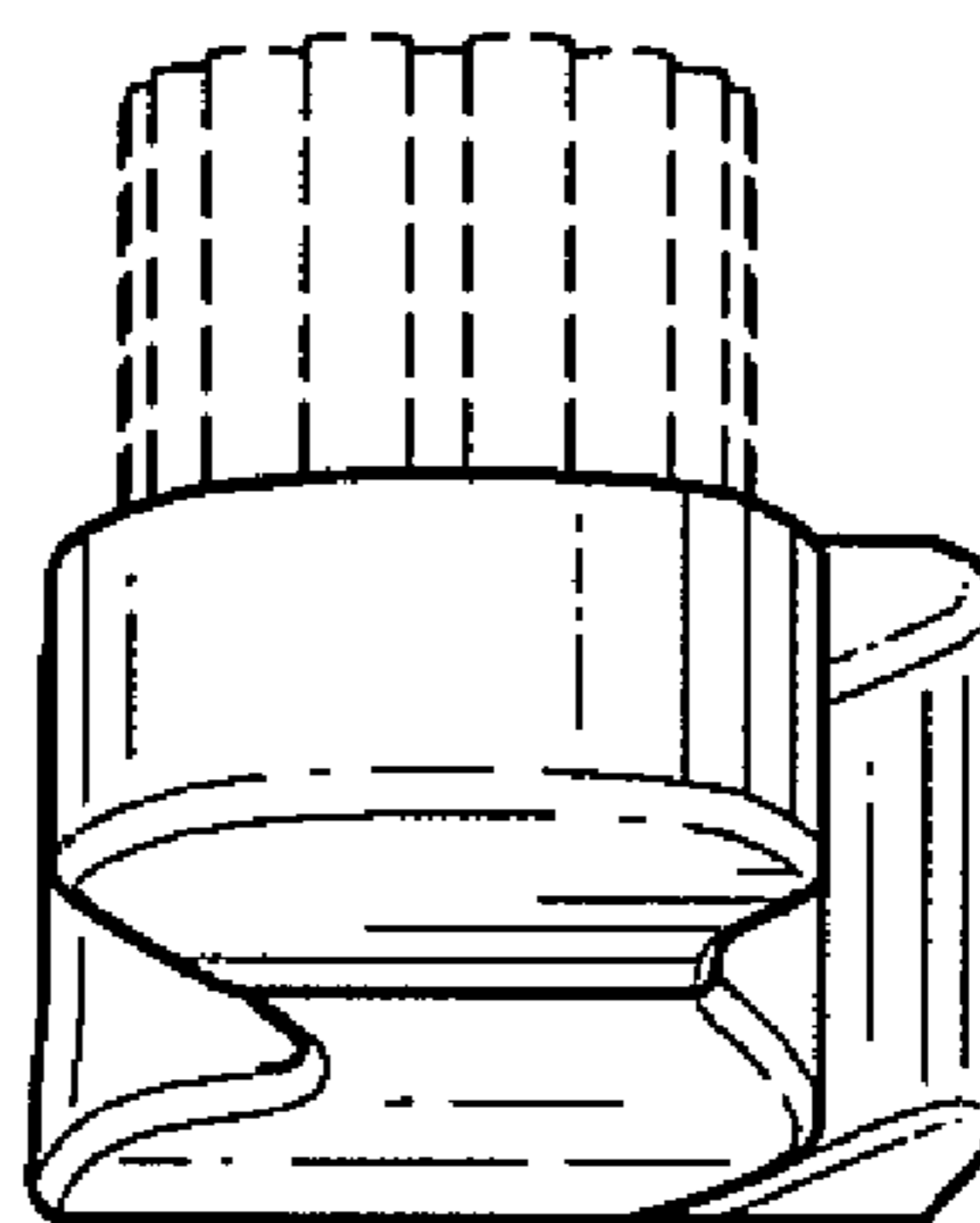

FIG. 7