



US00D590531S

(12) **United States Design Patent**
Ma

(10) **Patent No.:** **US D590,531 S**
(45) **Date of Patent:** **** Apr. 14, 2009**

(54) **LIGHTING DEVICE**

(75) Inventor: **Lai King Ma**, Fanling (HK)

(73) Assignee: **Eveready Battery Co., Inc.**, St. Louis, MO (US)

(**) Term: **14 Years**

(21) Appl. No.: **29/324,325**

(22) Filed: **Sep. 10, 2008**

(51) **LOC (9) Cl.** **26-05**

(52) **U.S. Cl.** **D26/60; D26/37**

(58) **Field of Classification Search** **D26/28, D26/37, 39, 60-63; 362/98, 99, 396, 473-476**
See application file for complete search history.

(56) **References Cited**

U.S. PATENT DOCUMENTS

D345,615 S *	3/1994	Tsushi	D26/28
D390,678 S *	2/1998	Matthes	D26/37
D496,479 S *	9/2004	Ashfield	D26/37
D507,671 S *	7/2005	Rice	D26/37
D523,573 S *	6/2006	Lee	D26/28
D541,452 S *	4/2007	Schnell	D26/39
D544,113 S *	6/2007	Ueda et al.	D26/28
D548,384 S *	8/2007	Komar	D26/60
D566,311 S *	4/2008	Schnell	D26/39

D570,023 S * 5/2008 Lee D26/60

OTHER PUBLICATIONS

Blackburn—Flea Front Bicycle Headlight/ found at greenfishsports.com on Feb. 16, 2009.*

* cited by examiner

Primary Examiner—Clare E Heflin

(74) *Attorney, Agent, or Firm*—Gregory J. Adams

(57) **CLAIM**

I claim the ornamental design for a lighting device, as shown and described.

DESCRIPTION

FIG. 1 is a perspective view of a lighting device showing the new design;

FIG. 2 is a top view thereof;

FIG. 3 is a bottom view thereof;

FIG. 4 is a front view thereof;

FIG. 5 is a rear view thereof;

FIG. 6 is a right side view thereof; and,

FIG. 7 is a left side view thereof.

Any broken line(s) shown are for illustrative purposes only and form no part of the claimed design.

1 Claim, 4 Drawing Sheets

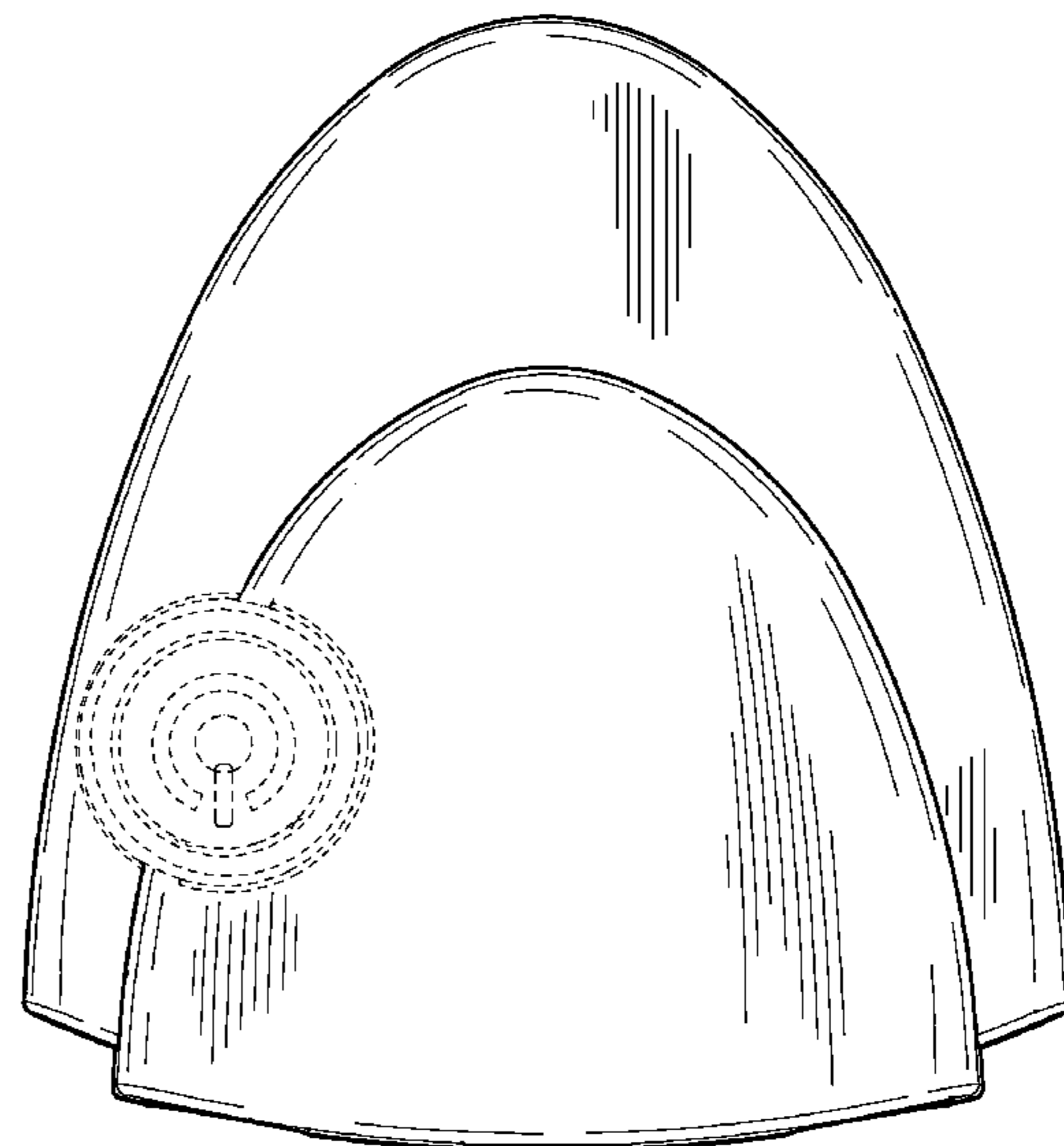
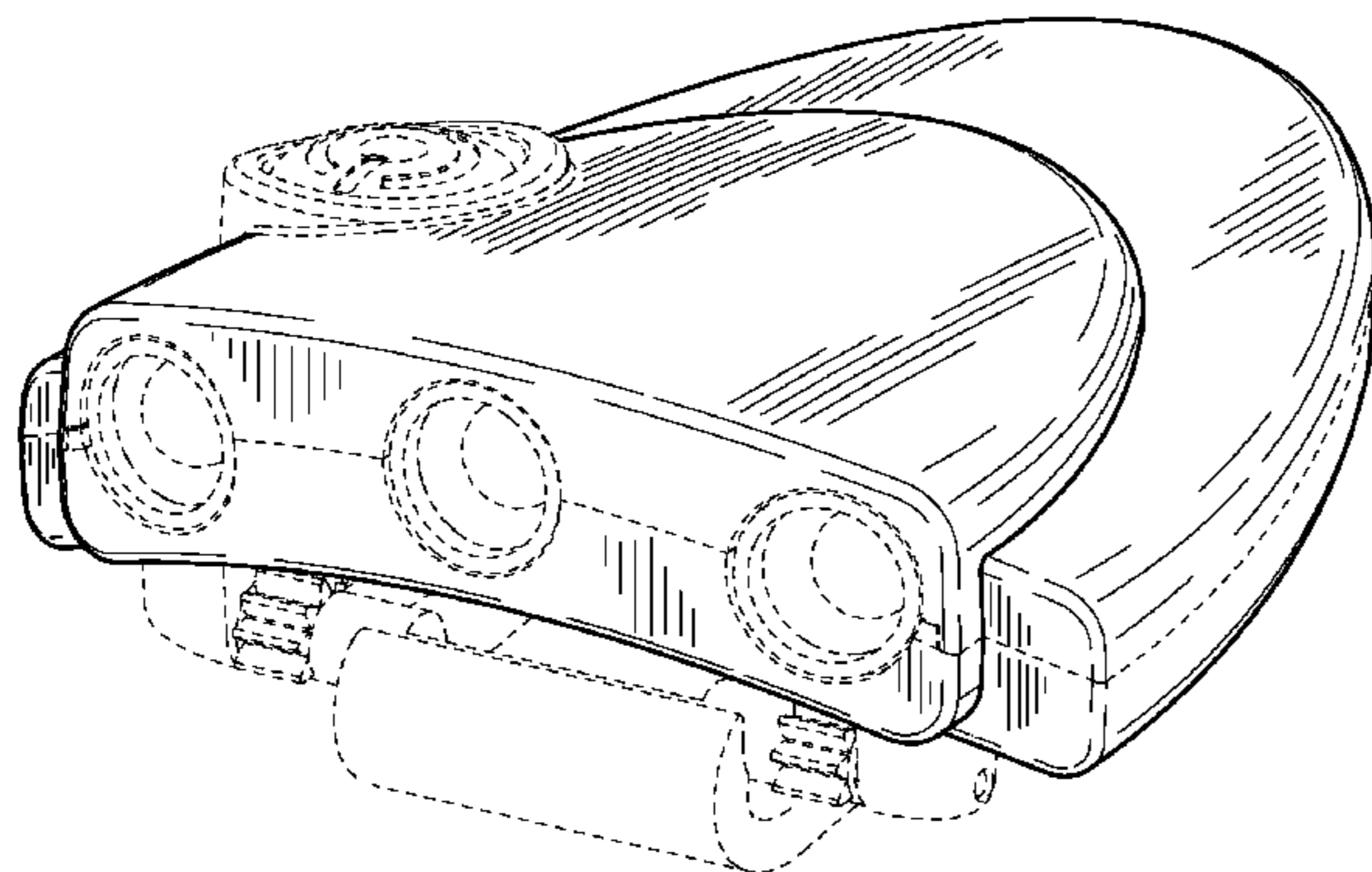

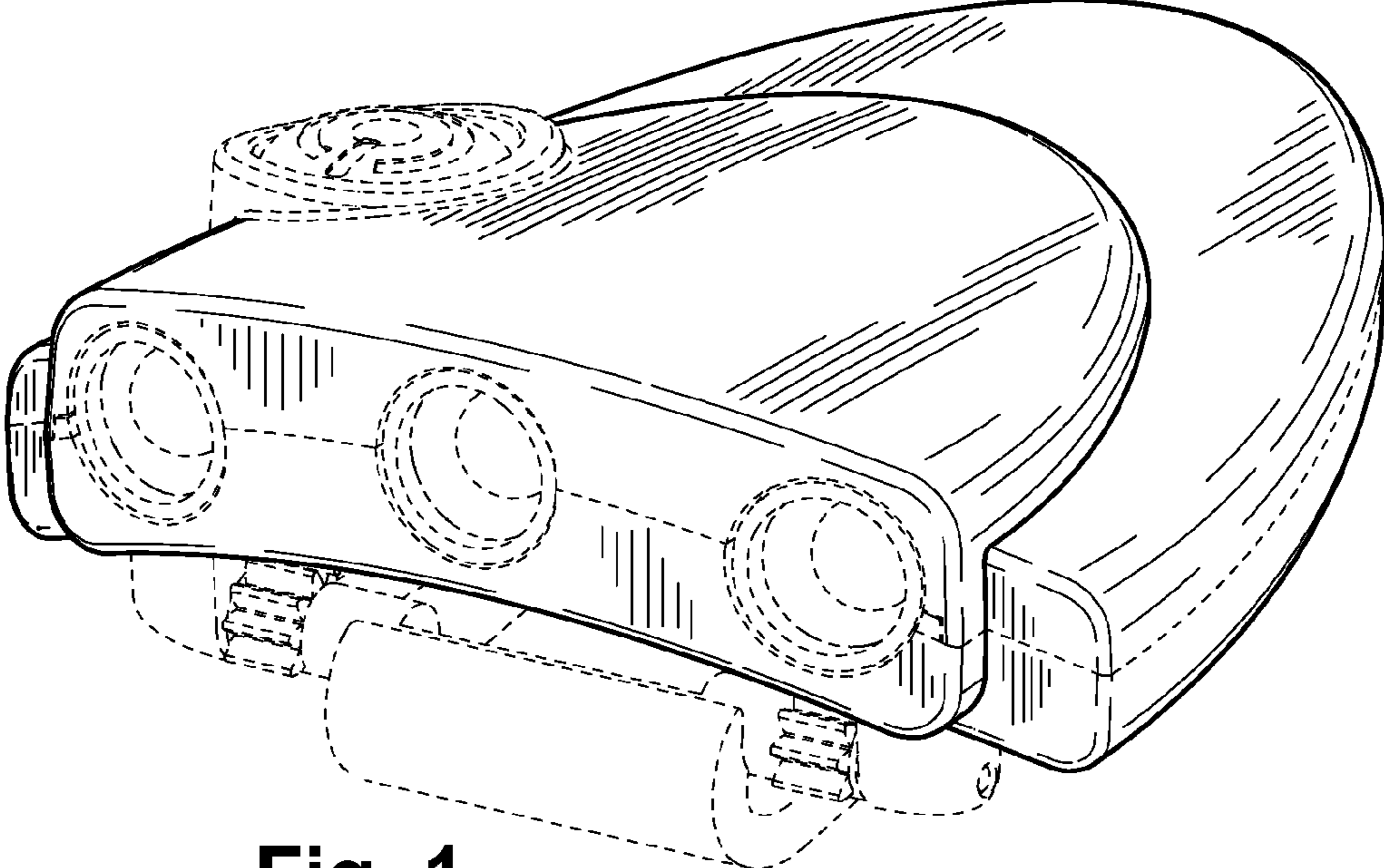

Fig. 1

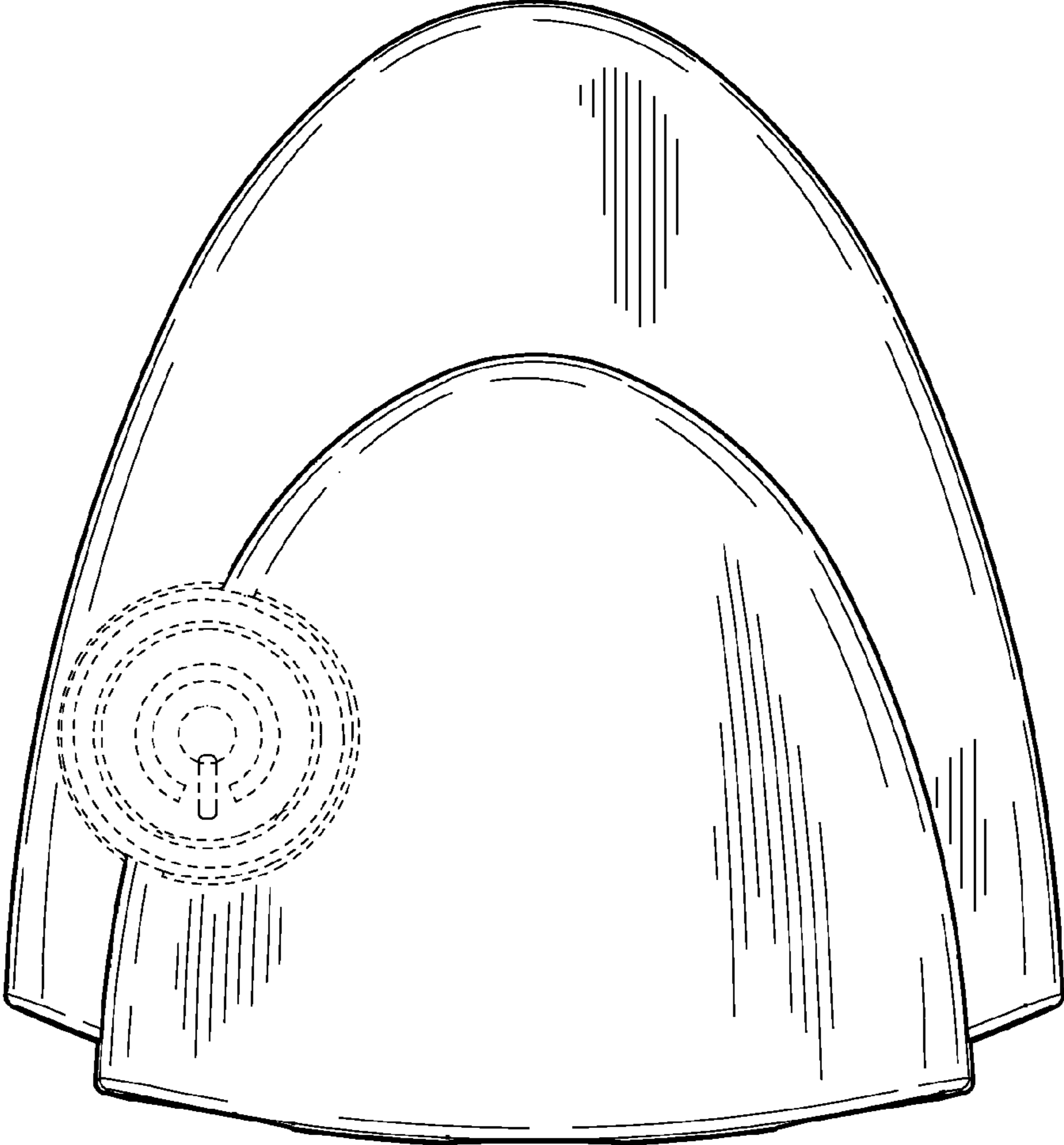

Fig. 2

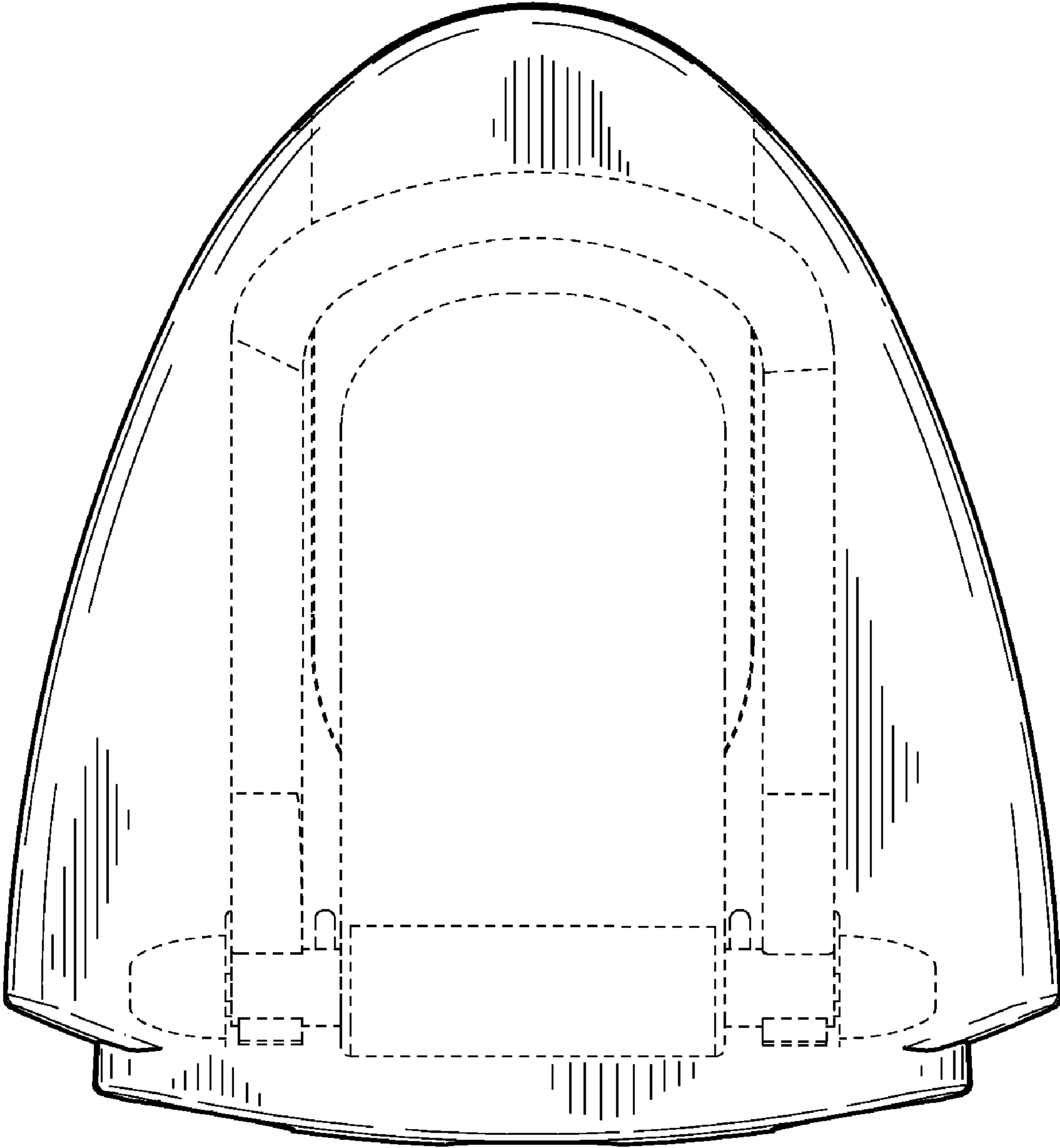

Fig. 3

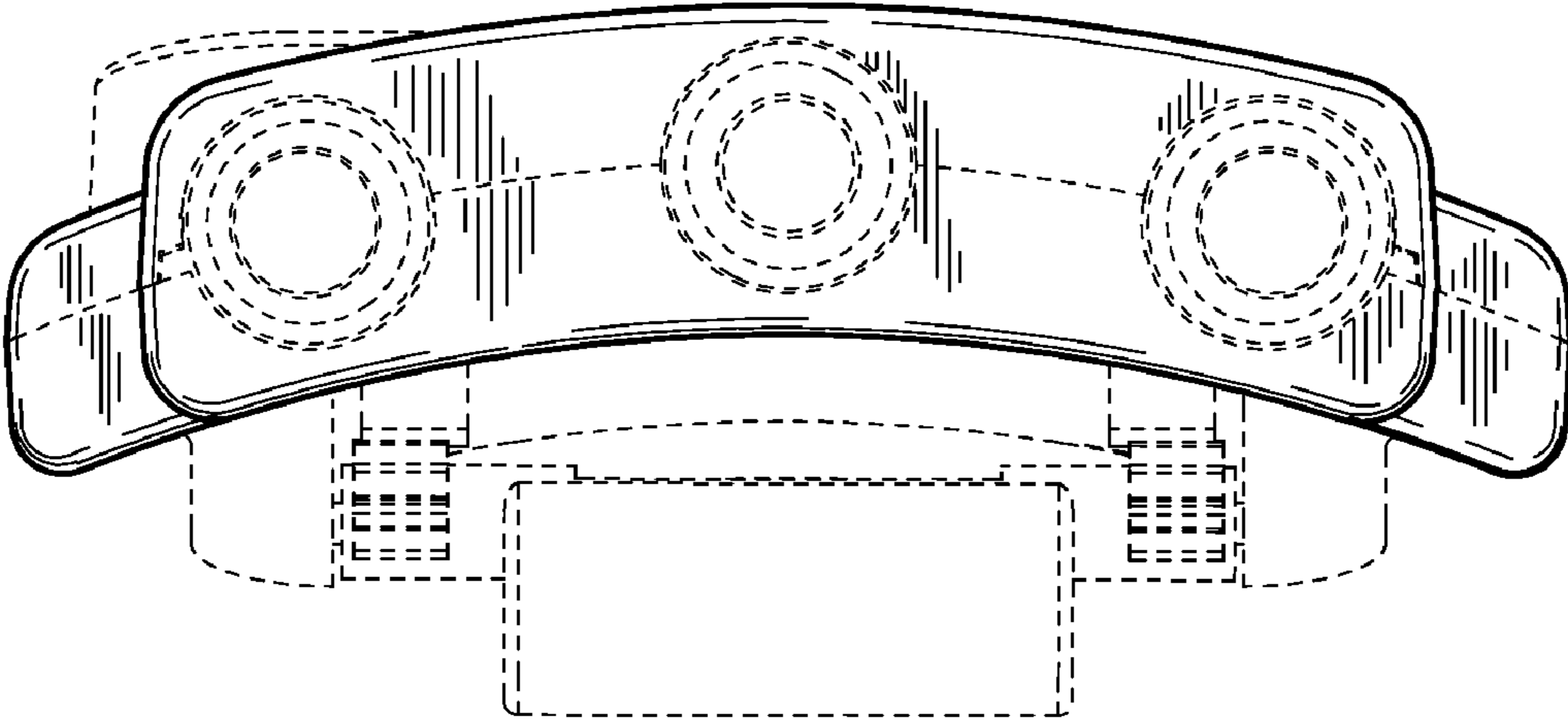

Fig. 4

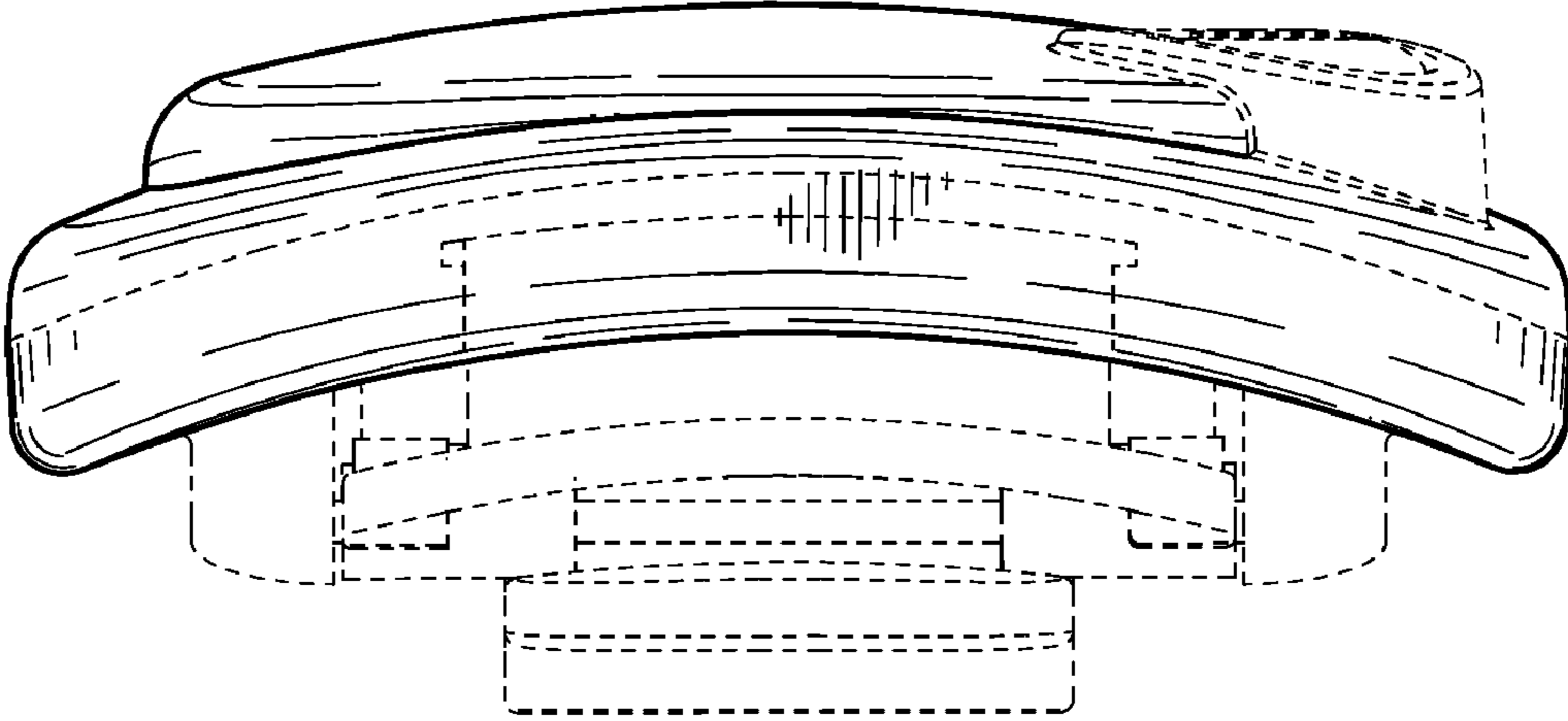

Fig. 5

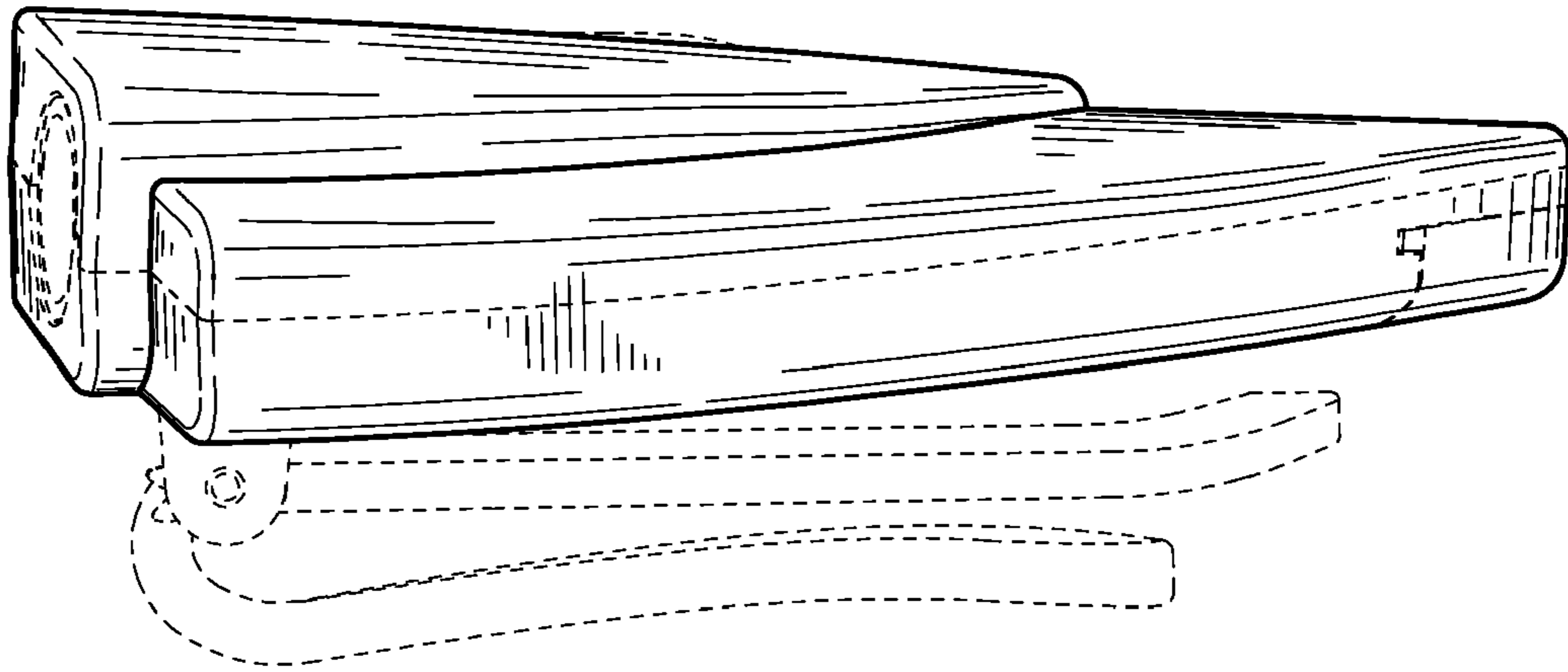

Fig. 6

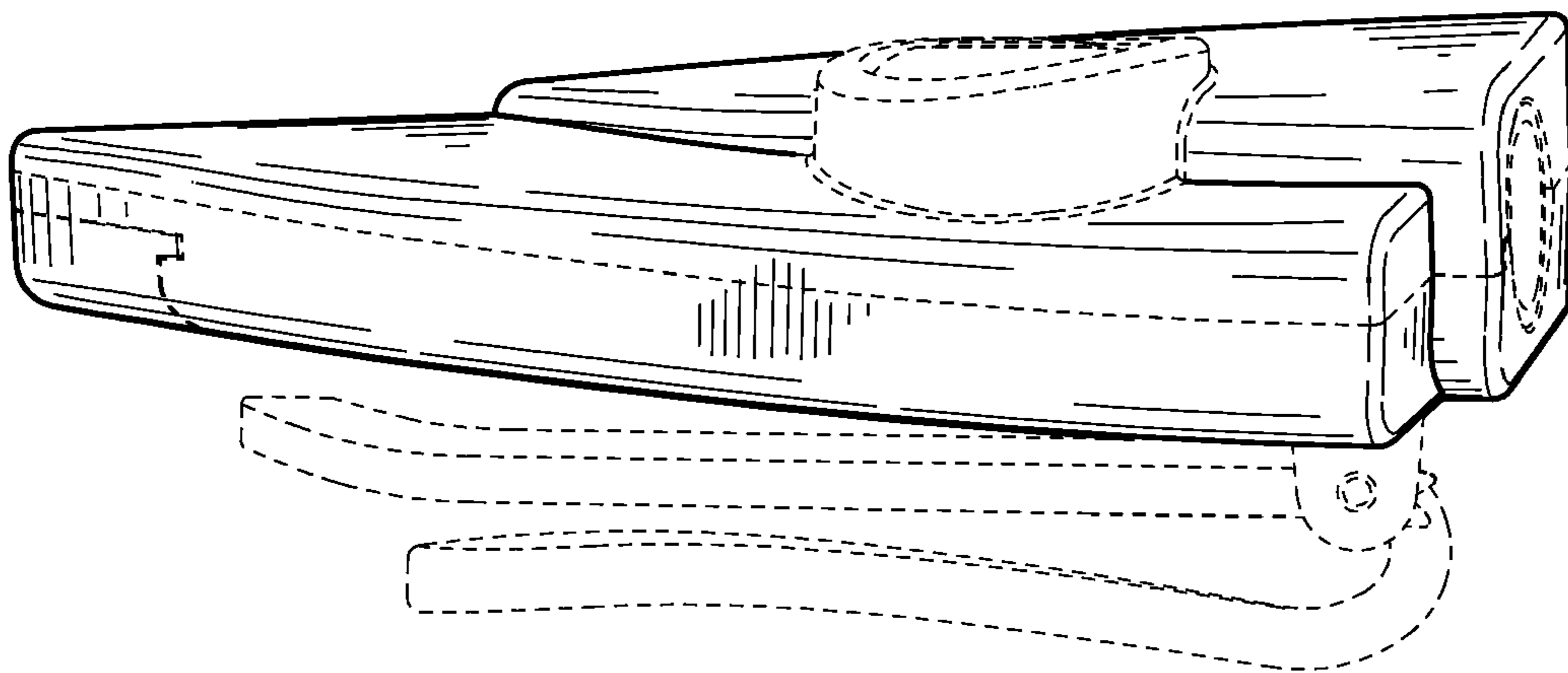

Fig. 7