



US00D590427S

(12) **United States Design Patent**
Kim

(10) **Patent No.:** **US D590,427 S**
(45) **Date of Patent:** **** Apr. 14, 2009**

(54) **DIGITAL CAMERA**

(75) Inventor: **Tae Ho Kim**, Gyeonggi-Do (KR)

(73) Assignee: **Samsung Electronics Co., Ltd.** (KR)

(**) Term: **14 Years**

(21) Appl. No.: **29/244,517**

(22) Filed: **Dec. 9, 2005**

(30) **Foreign Application Priority Data**

Sep. 6, 2005 (KR) 30-2005-0030185

(51) **LOC (9) Cl.** **16-01**

(52) **U.S. Cl.** **D16/202; D16/218**

(58) **Field of Classification Search** D16/200–206,
D16/208–209, 216–217; 348/373–376, 231.6,
348/231.7; 358/906, 909.1; 396/6, 60, 211,
396/535–541

See application file for complete search history.

(56) **References Cited**

U.S. PATENT DOCUMENTS

D270,840 S *	10/1983	Soda	D16/209
D271,207 S *	11/1983	Soda	D16/218
D296,214 S *	6/1988	Suyama et al.	D16/204
D319,453 S *	8/1991	Isozaki	D16/209
D387,078 S *	12/1997	Akita	D16/202
D431,583 S *	10/2000	Matsuda	D16/202
D440,590 S *	4/2001	Yoshida	D16/209
D450,073 S *	11/2001	Sumita	D16/202
D473,886 S *	4/2003	Katayama	D16/202
D502,195 S *	2/2005	Shimobayashi	D16/202
D507,586 S *	7/2005	Nakamura	D16/202

D524,344 S *	7/2006	Imai	D16/202
D525,638 S *	7/2006	Nakamura	D16/202
2004/0028398 A1 *	2/2004	Kai Chung	396/6

* cited by examiner

Primary Examiner—Ian Simmons

Assistant Examiner—Wan Laymon

(74) *Attorney, Agent, or Firm*—Irving Keschner

(57) **CLAIM**

The ornamental design for a digital camera, as shown.

DESCRIPTION

FIG. 1 is a perspective view of the ornamental design of the present invention;

FIG. 2 is a front elevational view of the ornamental design of the present invention;

FIG. 3 is a rear elevational view of the ornamental design of the present invention;

FIG. 4 is a left side elevational view of the ornamental design of the present invention, the right side elevational view being a mirror image thereof;

FIG. 5 is a right side elevational view of the ornamental design of the present invention;

FIG. 6 is a top plan view of the ornamental design of the present invention; and,

FIG. 7 is a bottom view of the ornamental design of the present invention.

The broken line in FIGS. 3 and 7 are for illustrative purposes only and form no part of the claimed design.

1 Claim, 5 Drawing Sheets

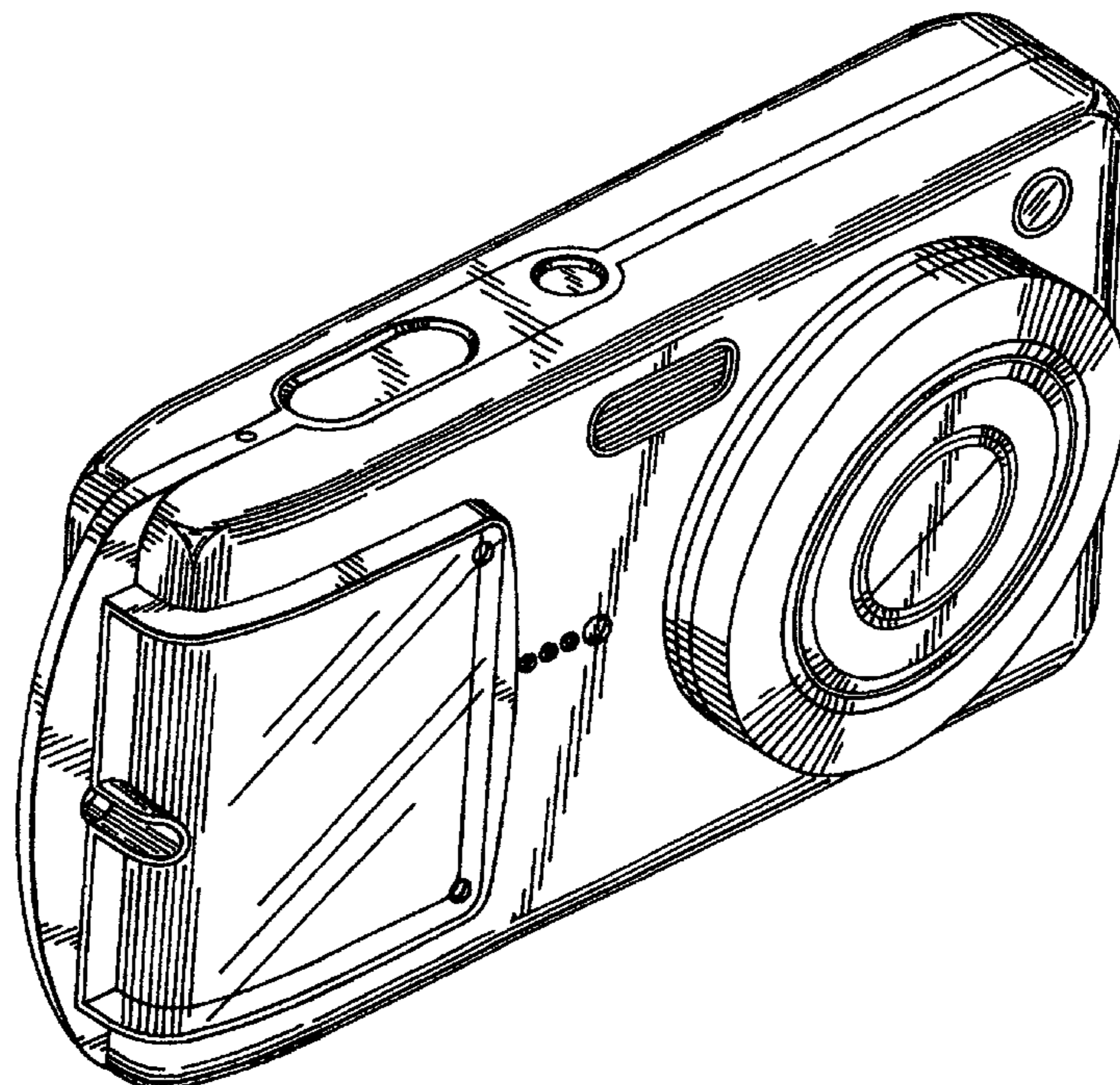

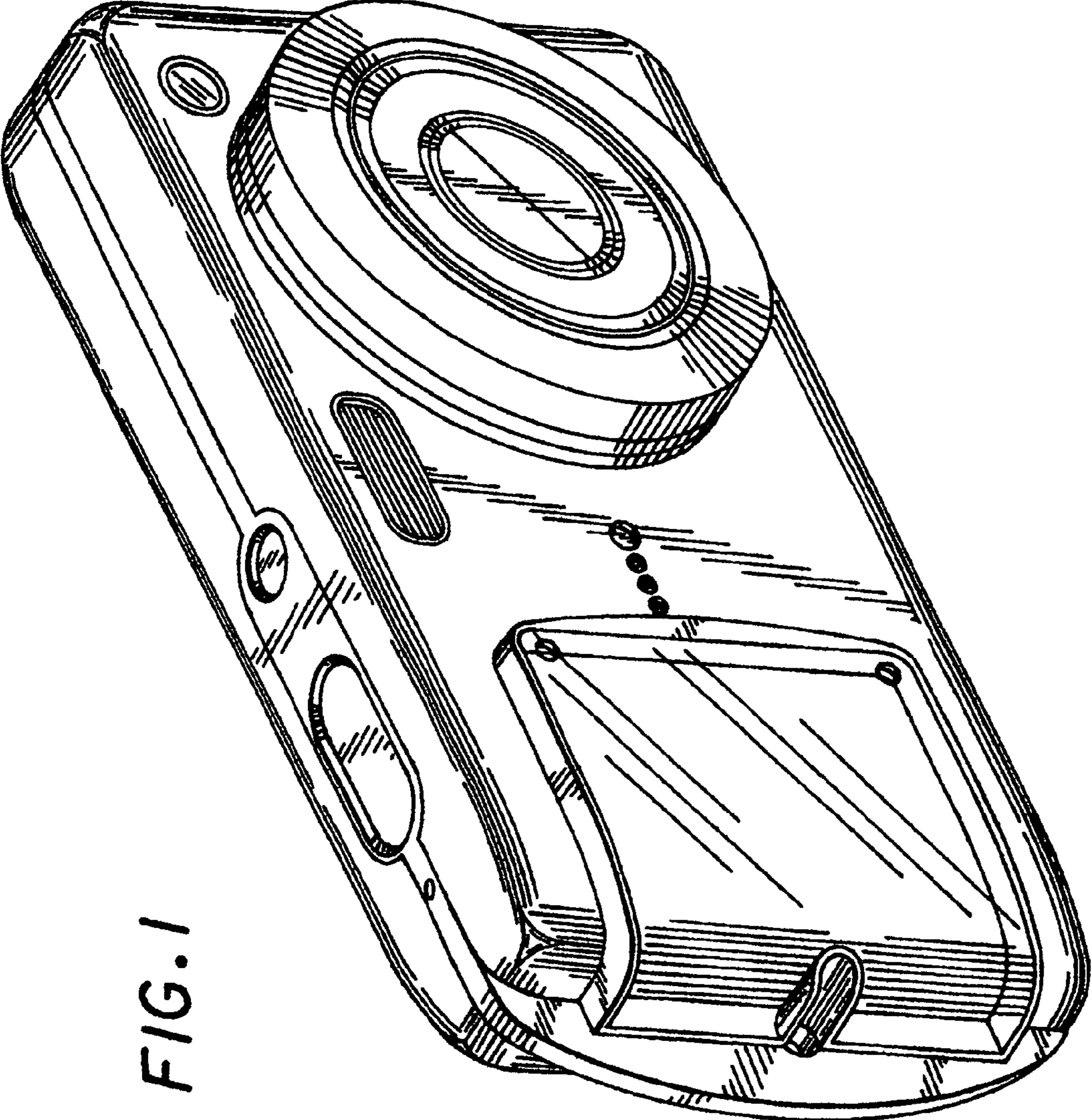

FIG. 1

FIG. 2

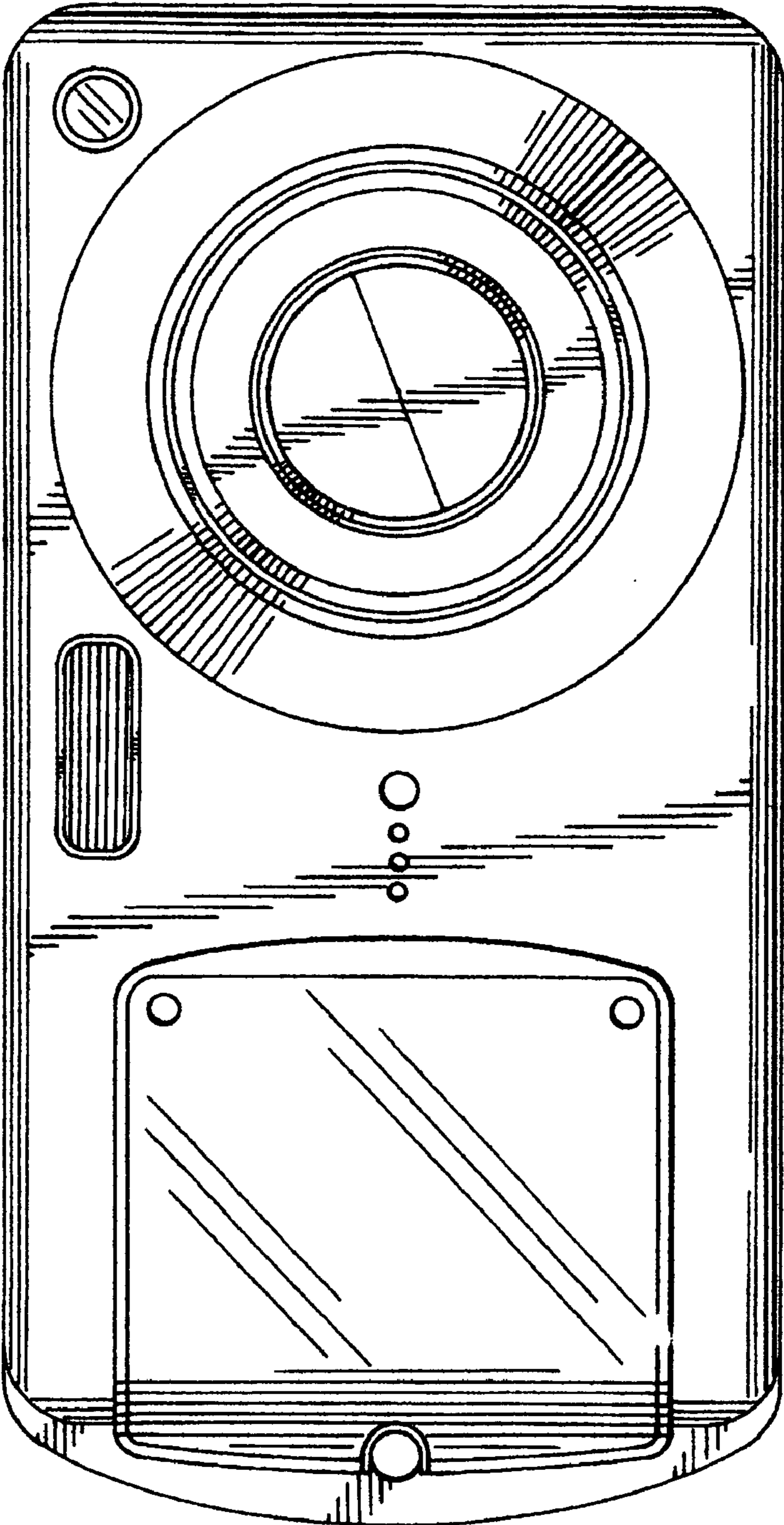

FIG. 3

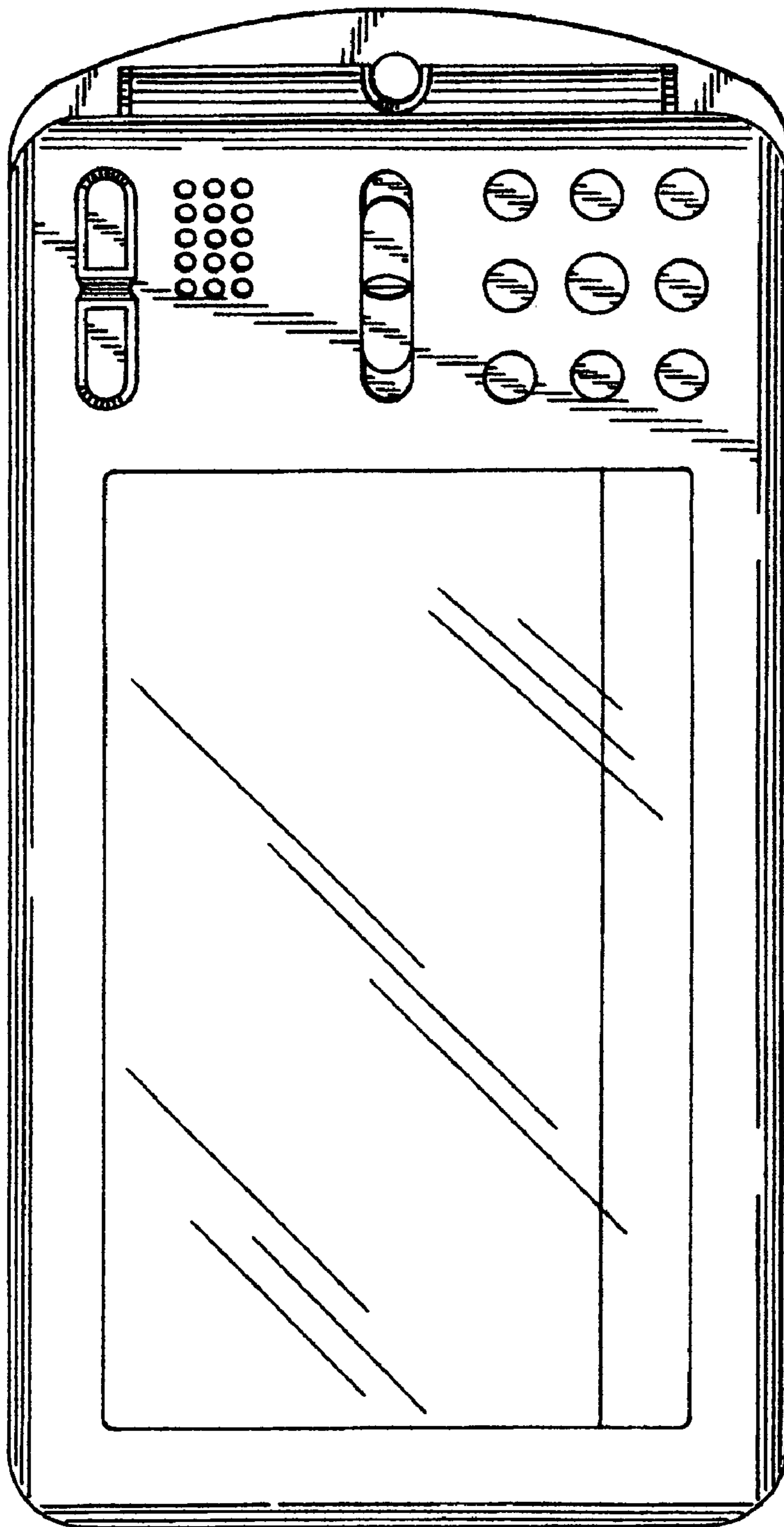

FIG. 4

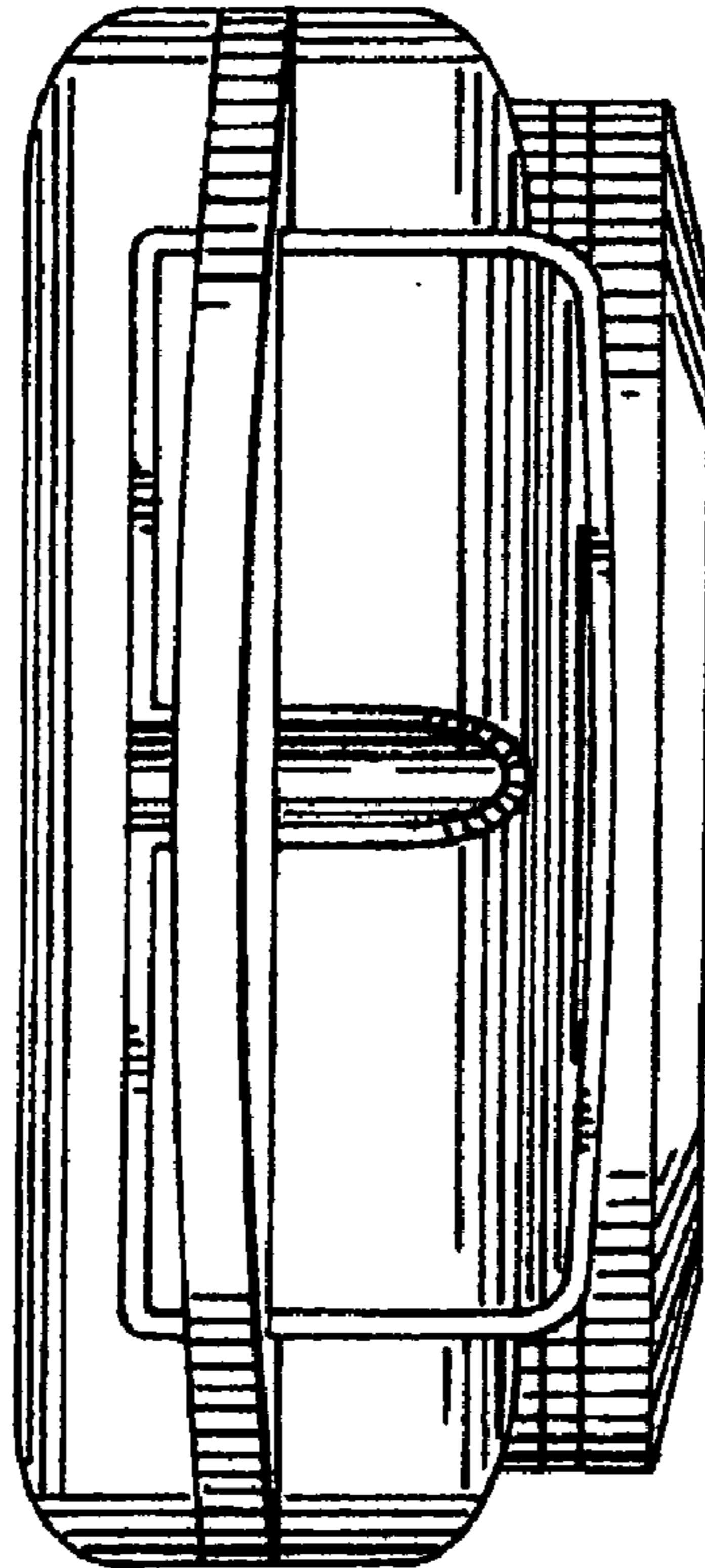

FIG. 5

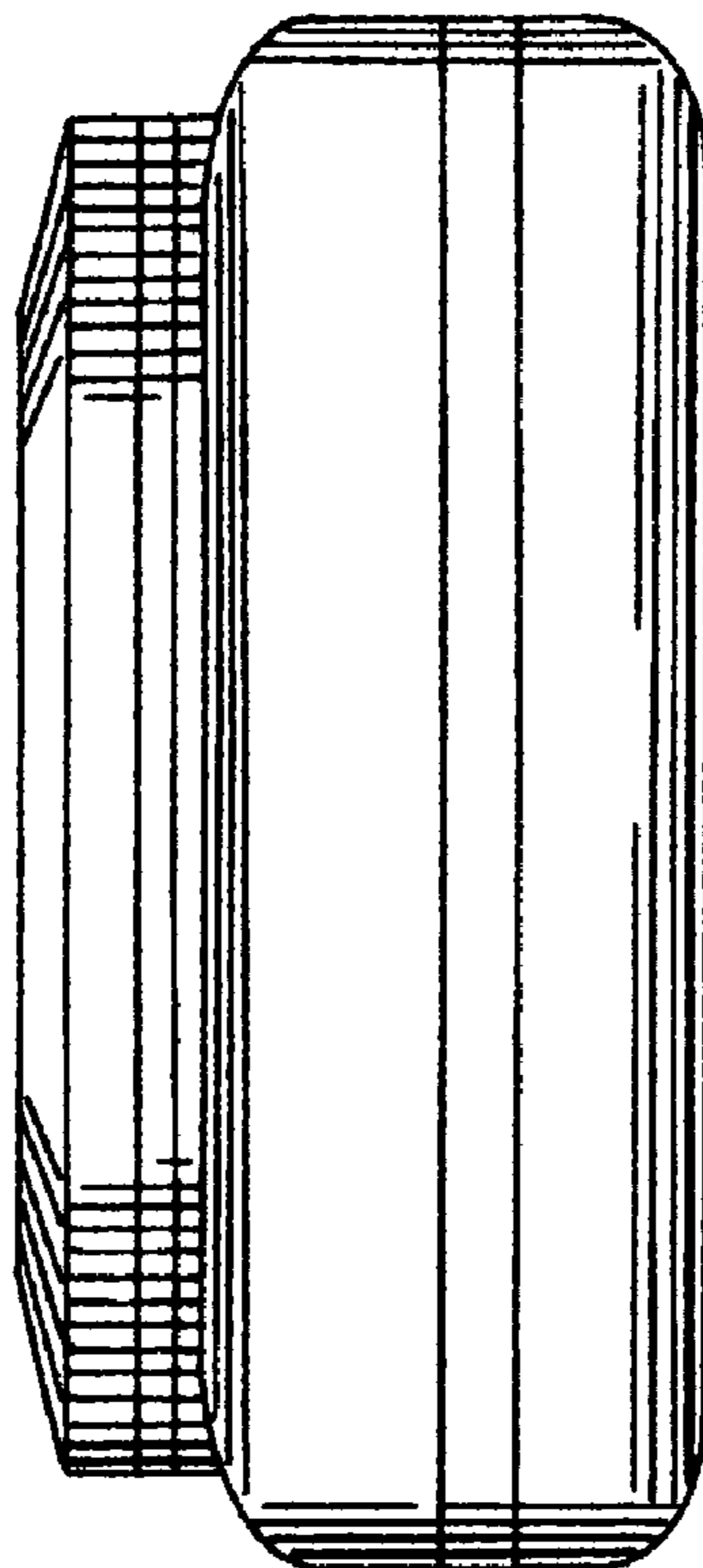

FIG. 6

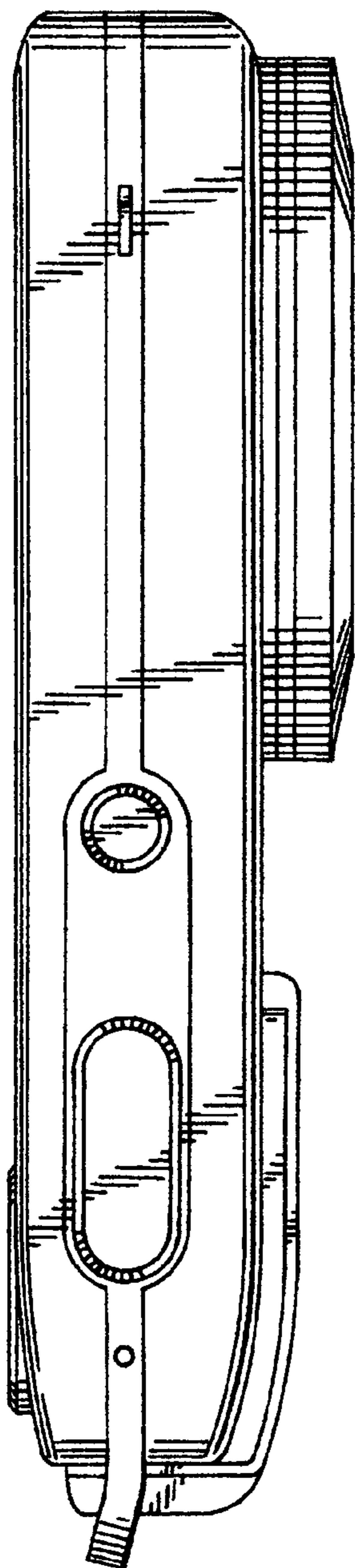

FIG. 7

