



US00D590309S

(12) **United States Design Patent**  
**Higashikawa**

(10) **Patent No.:** **US D590,309 S**  
(45) **Date of Patent:** **\*\* Apr. 14, 2009**

- (54) **PEDAL COVER FOR A VEHICLE**
- (75) Inventor: **Yoshitaka Higashikawa, Sakai (JP)**
- (73) Assignee: **Kubota Corporation, Osaka (JP)**
- (\*\*) Term: **14 Years**
- (21) Appl. No.: **29/255,258**
- (22) Filed: **Mar. 6, 2006**
- (30) **Foreign Application Priority Data**  
Sep. 21, 2005 (JP) ..... D2005-27238
- (51) **LOC (9) Cl.** ..... **12-16**
- (52) **U.S. Cl.** ..... **D12/174**
- (58) **Field of Classification Search** ..... D12/125,  
D12/174-177, 179, 184-185, 400; 280/259;  
74/490.14, 512, 563; 403/257  
See application file for complete search history.

- D260,508 S \* 9/1981 Weiner ..... D12/174
- D444,435 S \* 7/2001 Saleen ..... D12/174
- D444,436 S \* 7/2001 Saleen ..... D12/174
- D447,102 S \* 8/2001 Saleen ..... D12/174
- 6,622,592 B2 \* 9/2003 Lee ..... 74/563
- D540,227 S \* 4/2007 Doucet ..... D12/174

\* cited by examiner

*Primary Examiner*—Sandra Snapp  
(74) *Attorney, Agent, or Firm*—The Webb Law Firm

(57) **CLAIM**

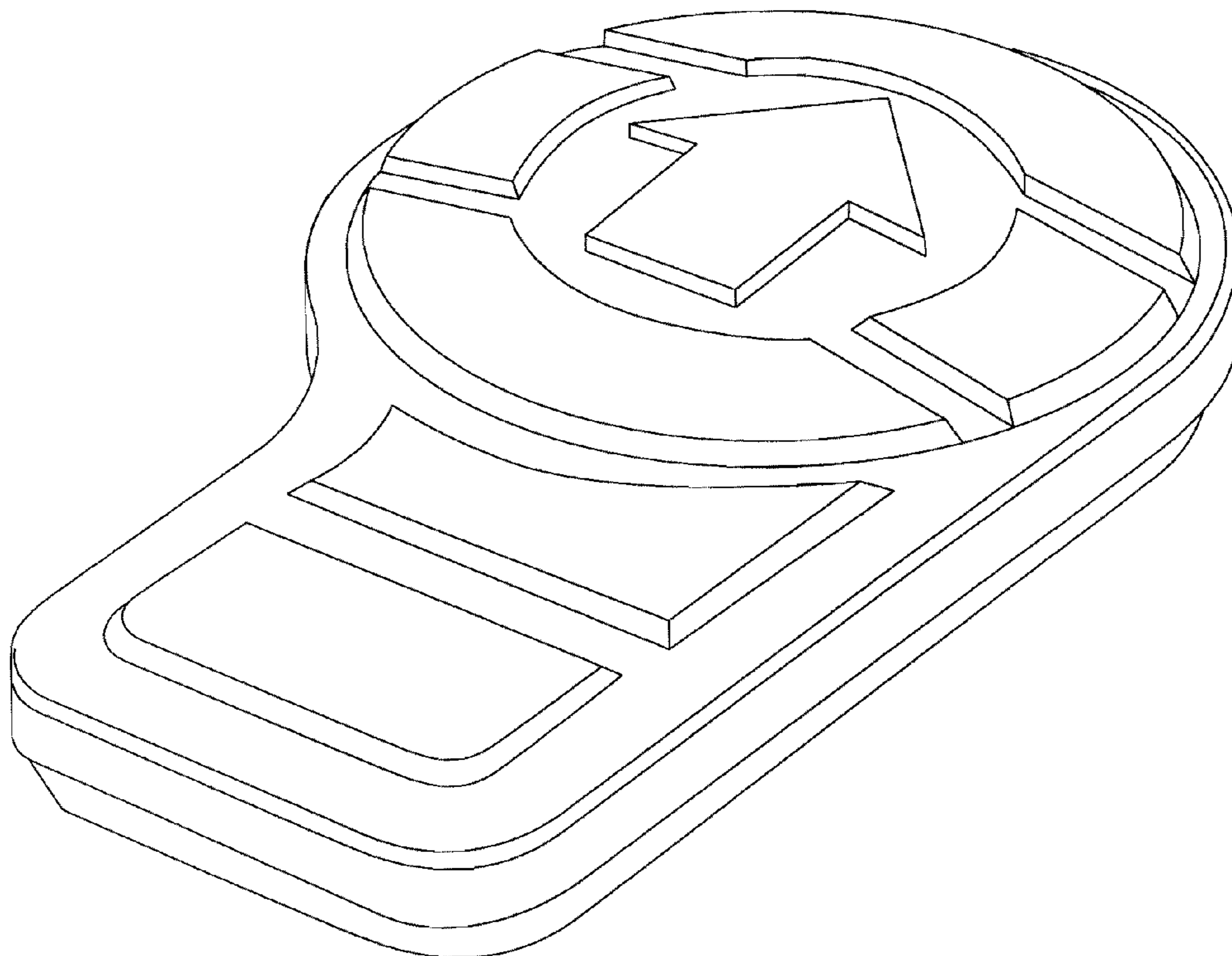
The ornamental design for a pedal cover for a vehicle, as shown and described.

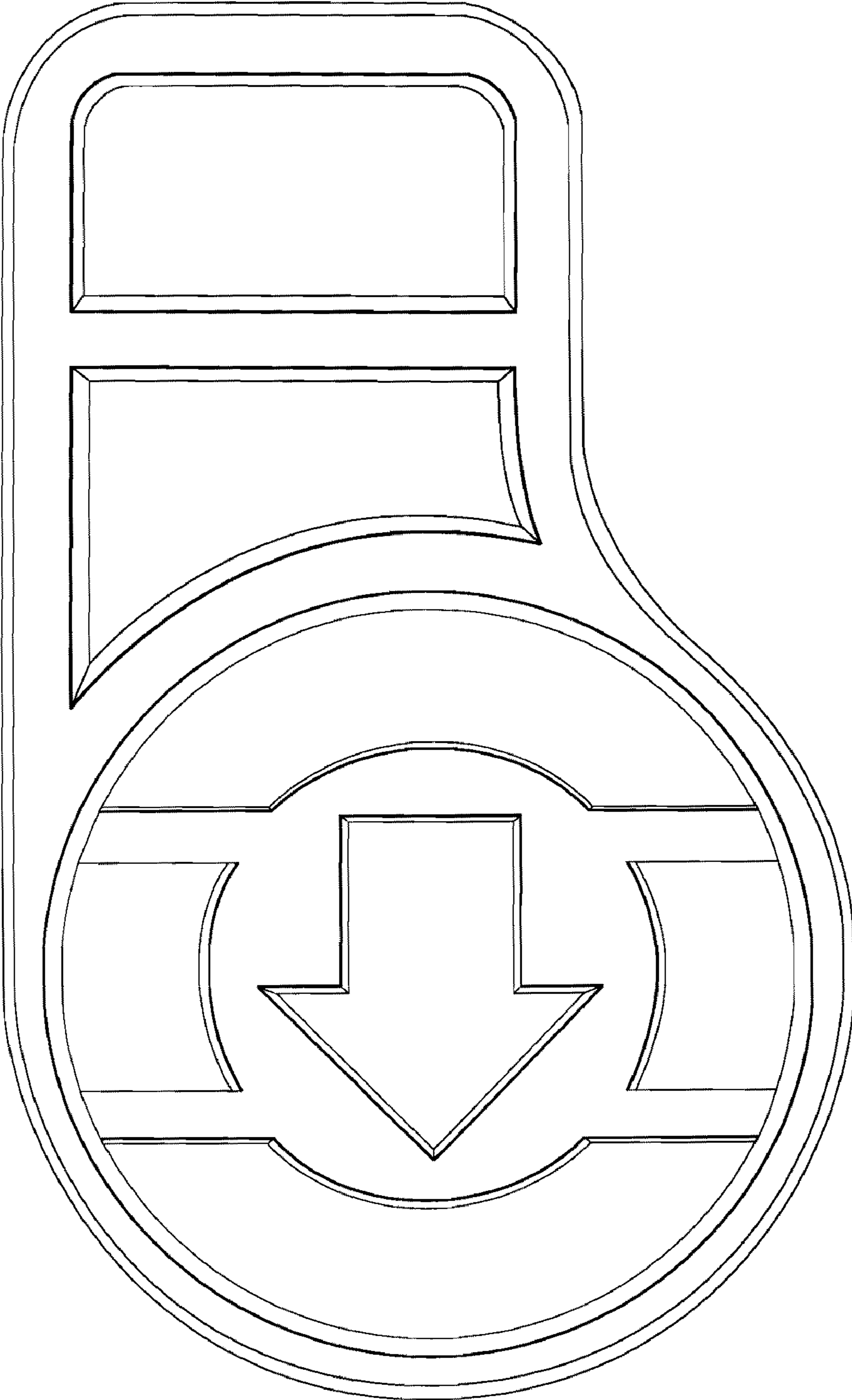
**DESCRIPTION**

FIG. 1 is a top view of a pedal cover for a vehicle;  
FIG. 2 is a left side view thereof;  
FIG. 3 is a right side view thereof;  
FIG. 4 is a front view thereof;  
FIG. 5 is a rear view thereof;  
FIG. 6 is a perspective view thereof; and,  
FIG. 7 is a top view of the pedal cover.  
The broken line showing in FIG. 7 is environmental only and not part of the claimed design.

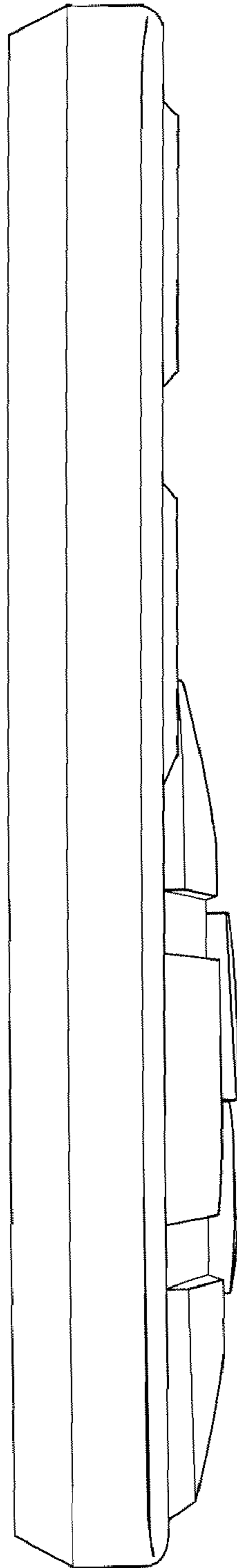
- (56) **References Cited**  
U.S. PATENT DOCUMENTS  
D48,341 S \* 12/1915 Winkler ..... D12/174  
1,455,675 A \* 5/1923 Sinclair ..... 74/563  
1,895,986 A \* 1/1933 Grant ..... 74/563  
D155,383 S \* 10/1949 Bricton ..... D12/174  
D192,853 S \* 5/1962 Wilson ..... D12/174  
D203,811 S \* 2/1966 Ruedin ..... D15/72

**1 Claim, 6 Drawing Sheets**

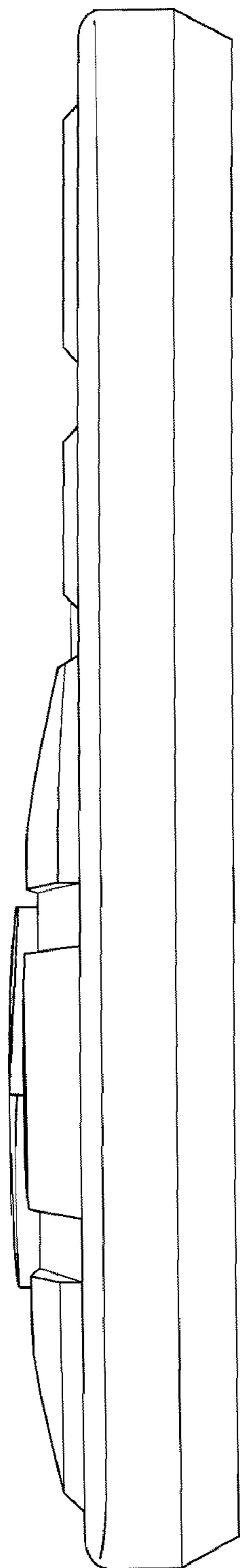




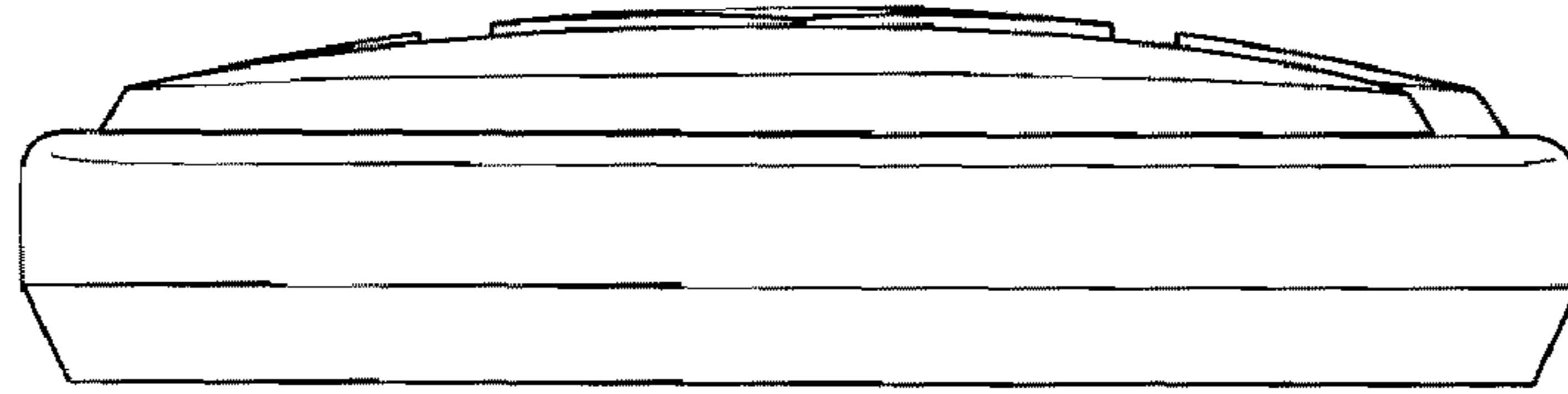
**FIG. 1**



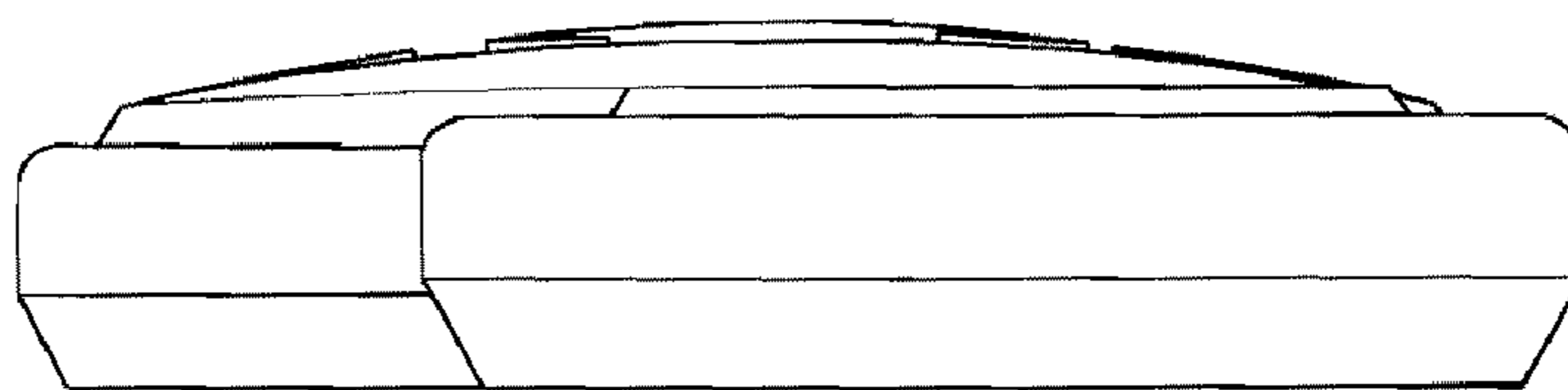
**FIG. 2**



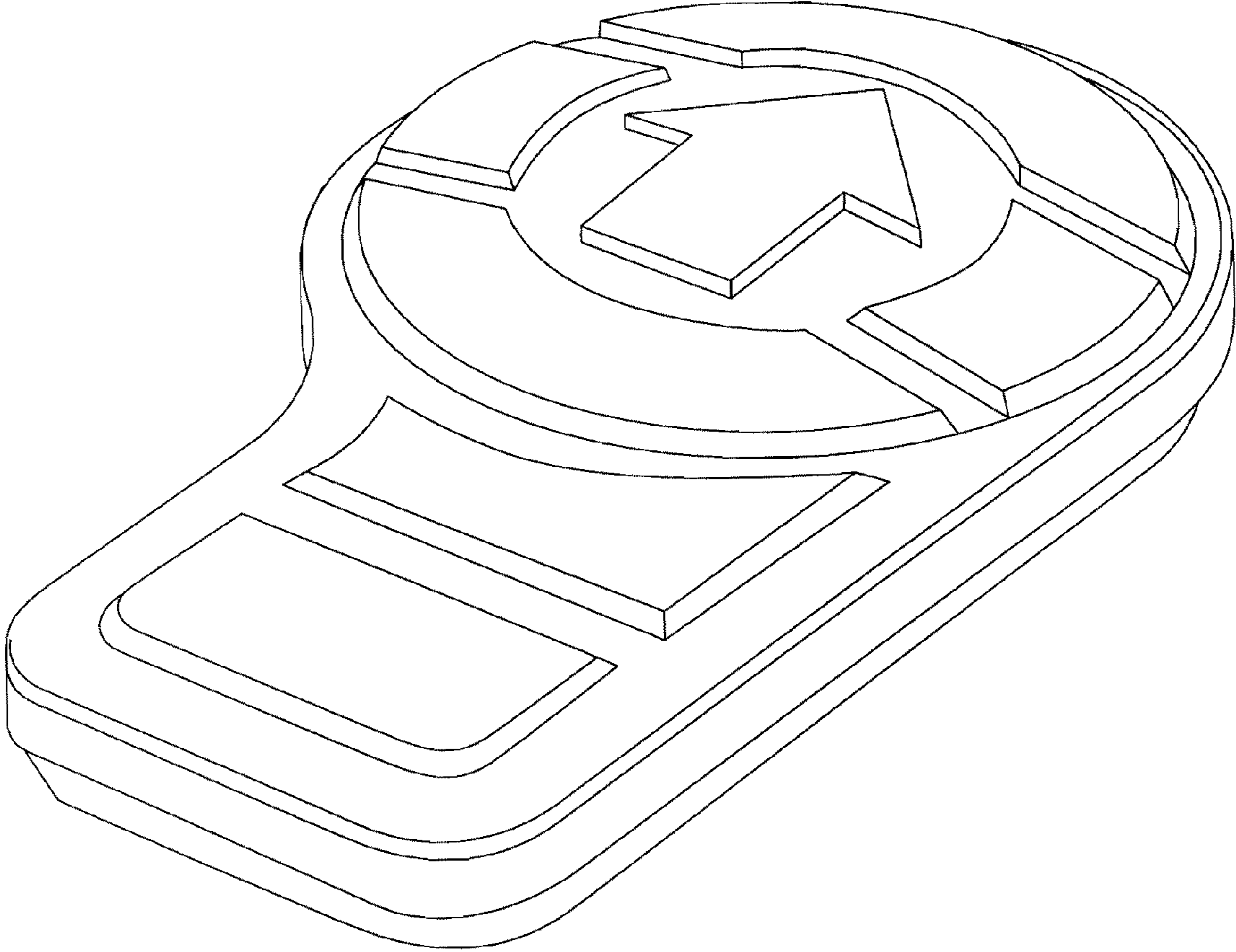
**FIG. 3**



**FIG. 4**



**FIG. 5**



**FIG. 6**

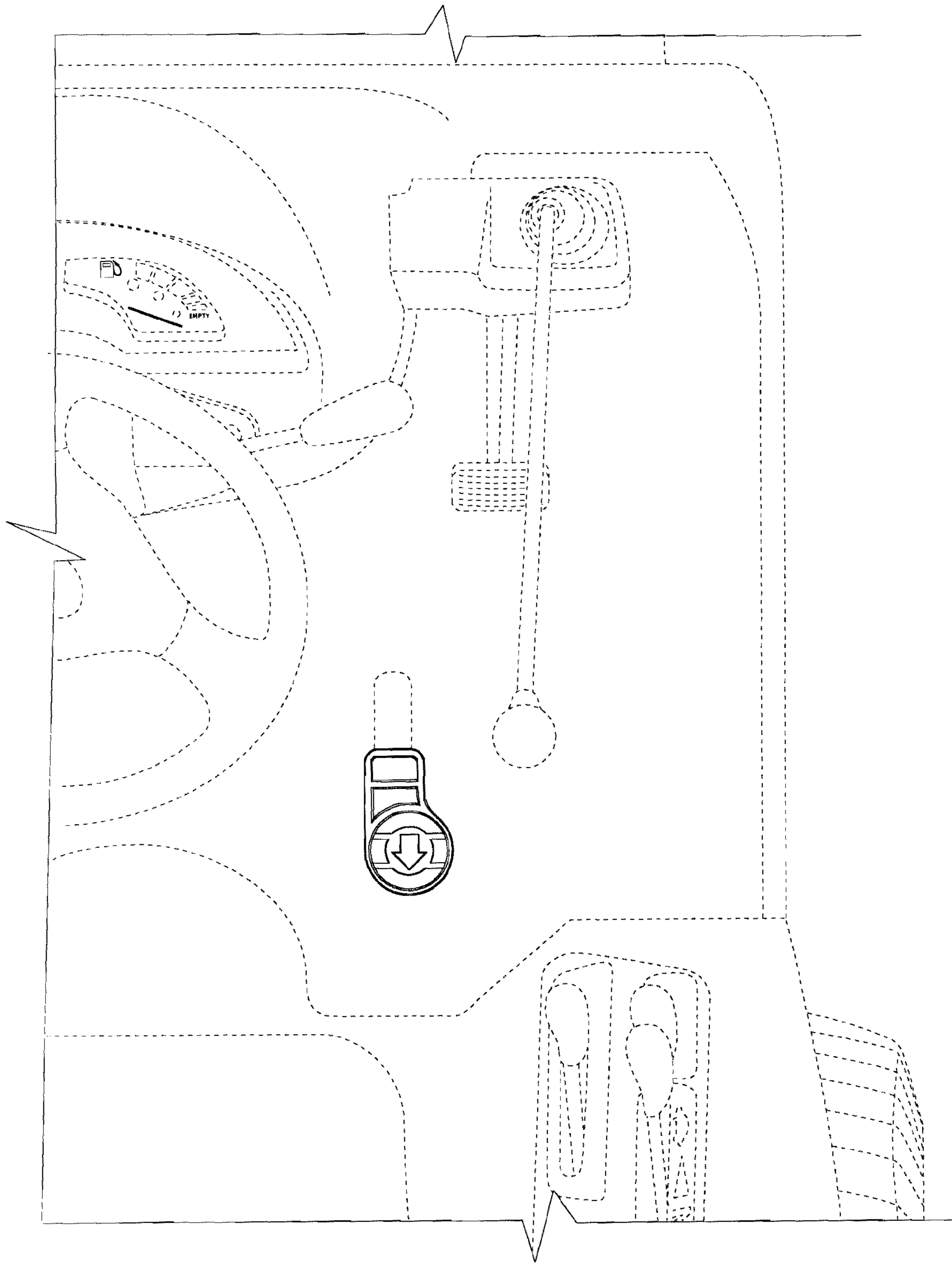


FIG. 7