



US00D590188S

(12) **United States Design Patent**
Tran

(10) **Patent No.:** **US D590,188 S**

(45) **Date of Patent:** **** Apr. 14, 2009**

(54) **FOOTBATH BASE**

(75) Inventor: **Minh Sang Tran**, Cambridge (CA)

(73) Assignee: **Gulfstream Plastics Ltd.**, Cambridge, Ontario (CA)

(**) Term: **14 Years**

(21) Appl. No.: **29/275,774**

(22) Filed: **Jan. 5, 2007**

(51) **LOC (9) Cl.** **06-01**

(52) **U.S. Cl.** **D6/495**

(58) **Field of Classification Search** D6/335–338,
D6/360–361, 367, 491, 495, 500–502; 297/188.01,
297/423.19, 135, 180.15; D28/56, 61; 4/622;
601/158

See application file for complete search history.

(56) **References Cited**

U.S. PATENT DOCUMENTS

D424,819	S	*	5/2000	Galati et al.	D6/336
D434,916	S	*	12/2000	Galati et al.	D6/336
D454,705	S	*	3/2002	Long et al.	D6/336
D455,017	S	*	4/2002	Tran	D6/336
D455,566	S	*	4/2002	Park	D6/336
D456,154	S	*	4/2002	Huynh et al.	D6/336
6,503,212	B2	*	1/2003	Park	601/158
D498,599	S	*	11/2004	Luong	D6/336
D504,783	S	*	5/2005	Park	D6/336
D505,021	S	*	5/2005	Kim	D6/336
D520,761	S	*	5/2006	Masuda	D6/336
D562,575	S	*	2/2008	Le	D6/336
2004/0060108	A1	*	4/2004	Hoon Park	4/622

2004/0261173	A1	*	12/2004	Chen	4/622
2006/0242760	A1	*	11/2006	Chao	4/622
2007/0226896	A1	*	10/2007	Fugate et al.	4/622

* cited by examiner

Primary Examiner—Sandra Snapp

(74) *Attorney, Agent, or Firm*—Banner & Witcoff, Ltd.

(57) **CLAIM**

The ornamental design for a footbath base, as shown and described.

DESCRIPTION

FIG. 1 is a front upper perspective view of a footbath base showing my new design;

FIG. 2 is a rear upper perspective view thereof;

FIG. 3 is a top plan view thereof;

FIG. 4 is a left side view thereof;

FIG. 5 is a bottom plan view thereof;

FIG. 6 is a right side view thereof;

FIG. 7 is a front view thereof;

FIG. 8 is a rear view thereof; and,

FIG. 9 is the perspective view as shown in FIG. 1 including a disclaimed broken line depiction of a footbath and chair.

The broken line showing of various regions in the figures, including the unshaded areas therein, is for illustrative purposes only and forms no part of the claimed design. The broken line showing of the footbath and chair in FIG. 9 is for illustrative purposes only and forms no part of the claimed design.

1 Claim, 5 Drawing Sheets

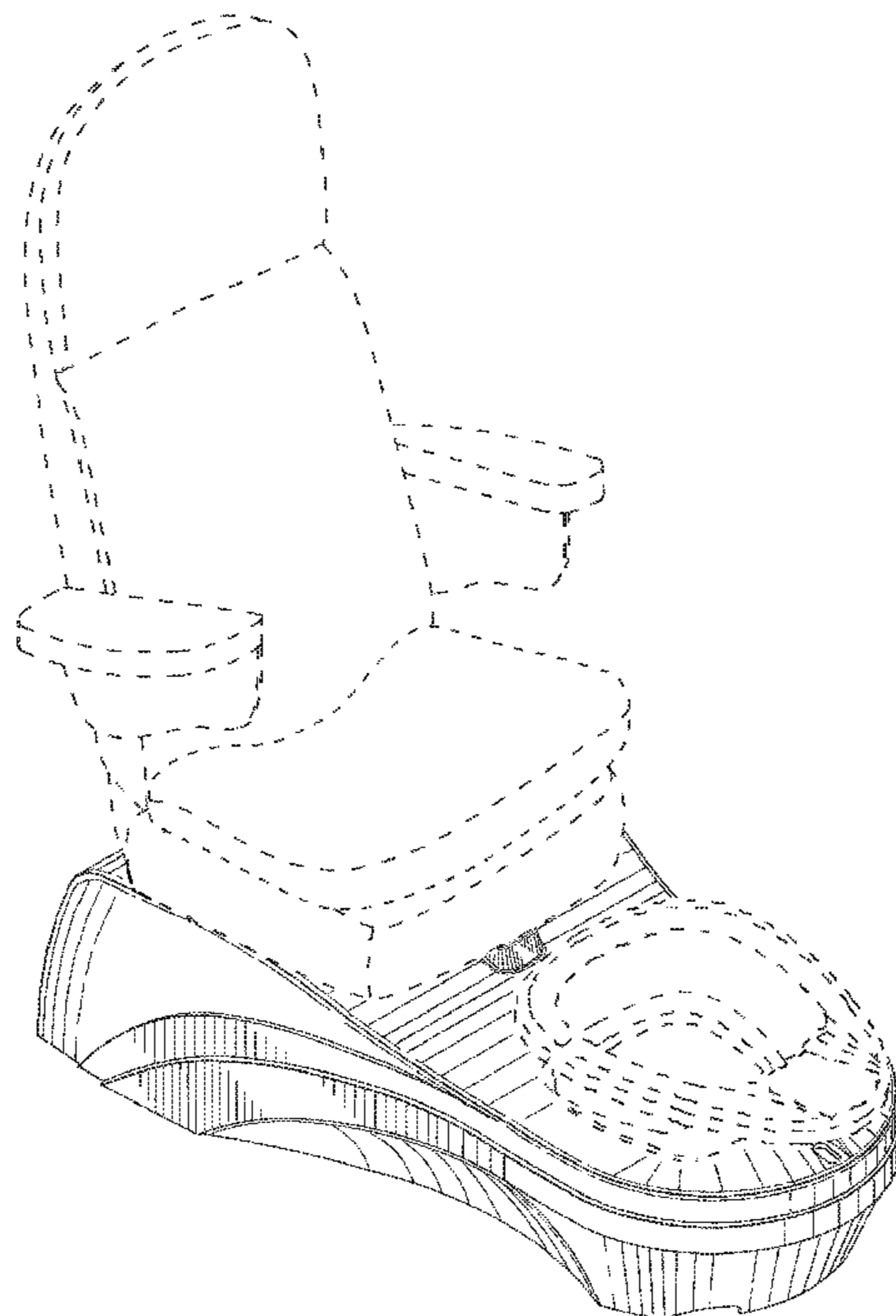

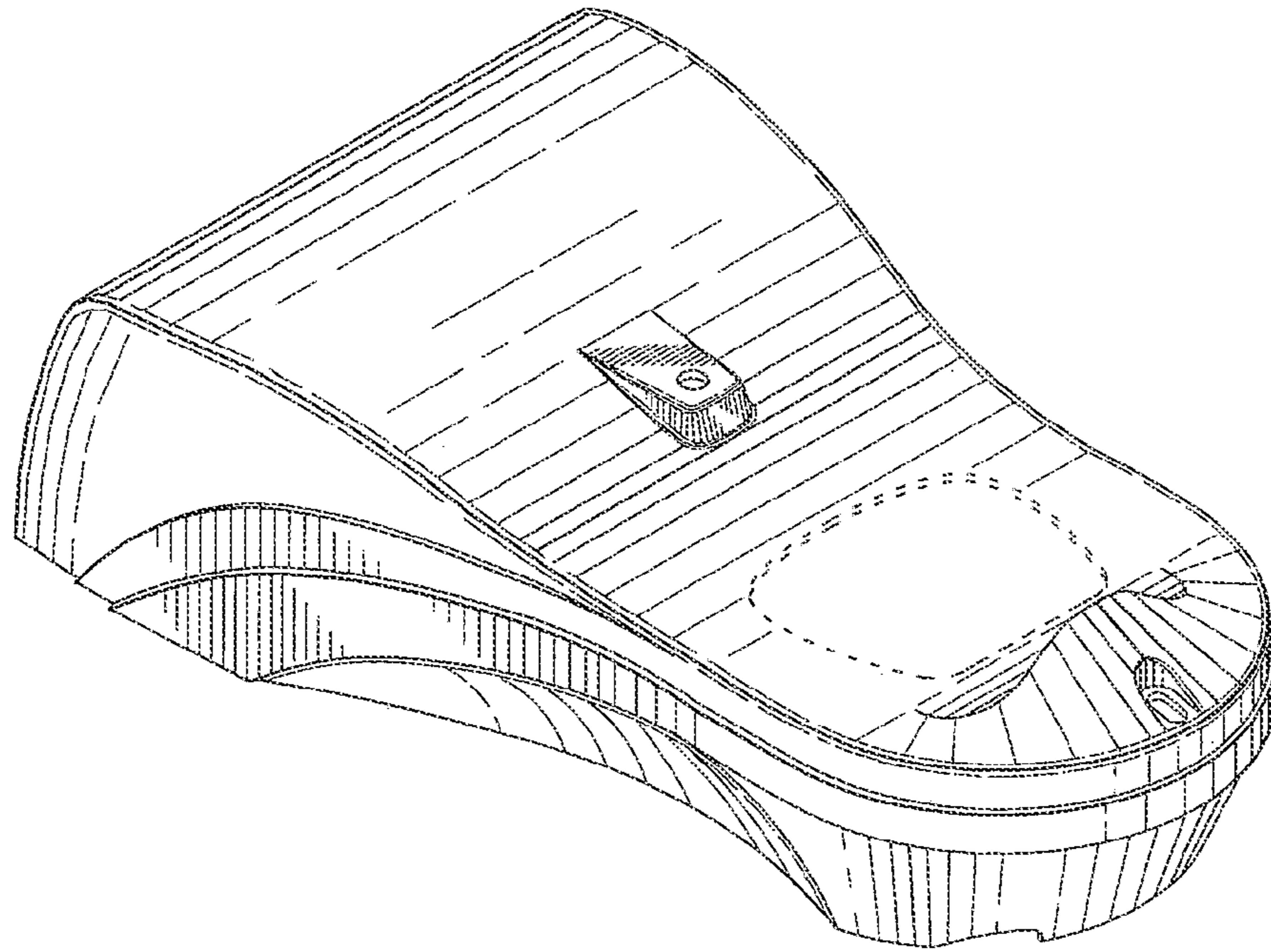

FIG. 1

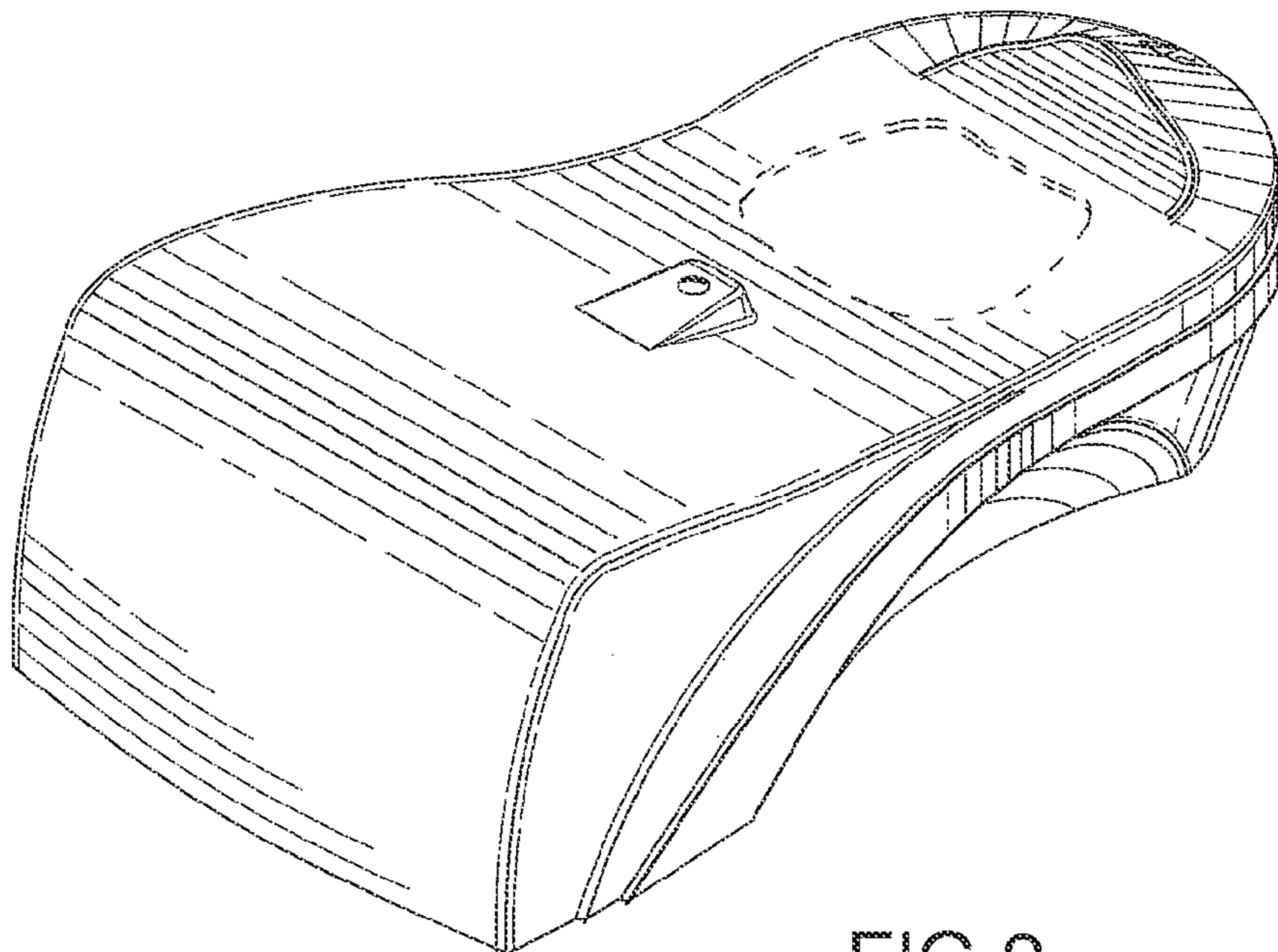

FIG. 2

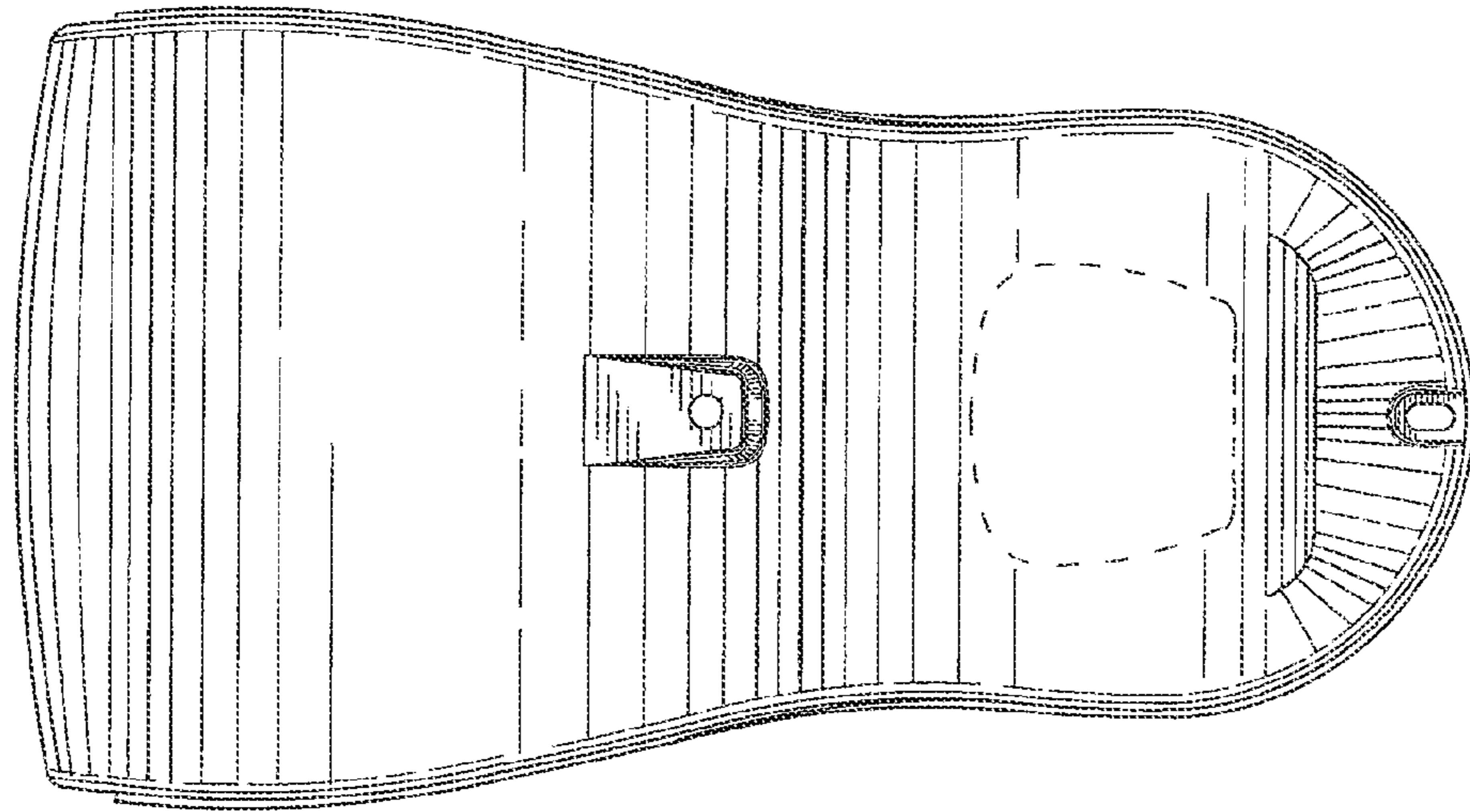

FIG. 3

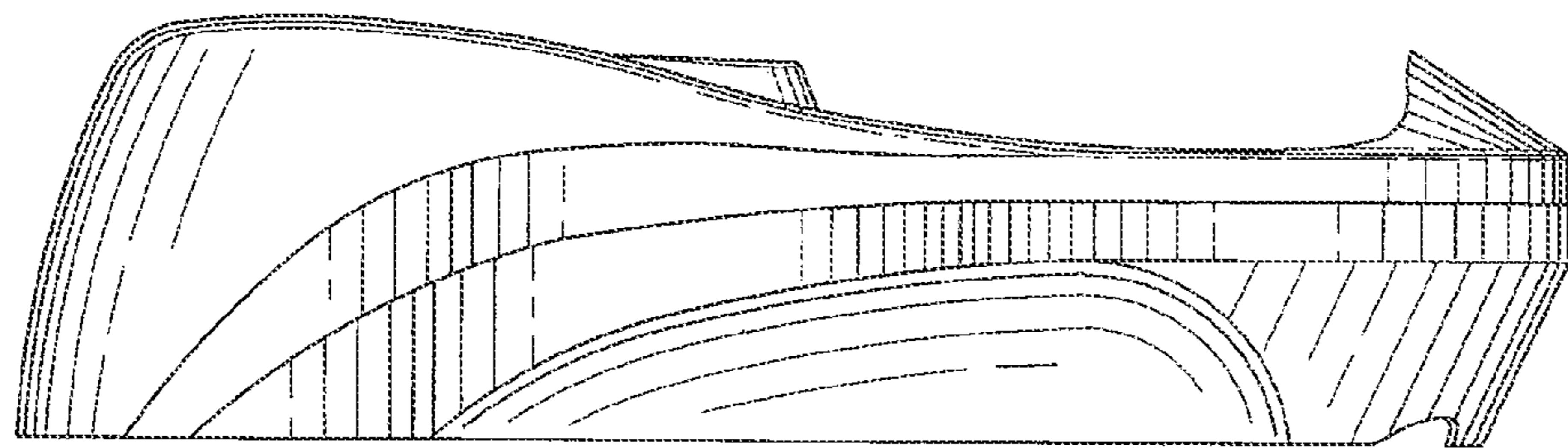

FIG. 4

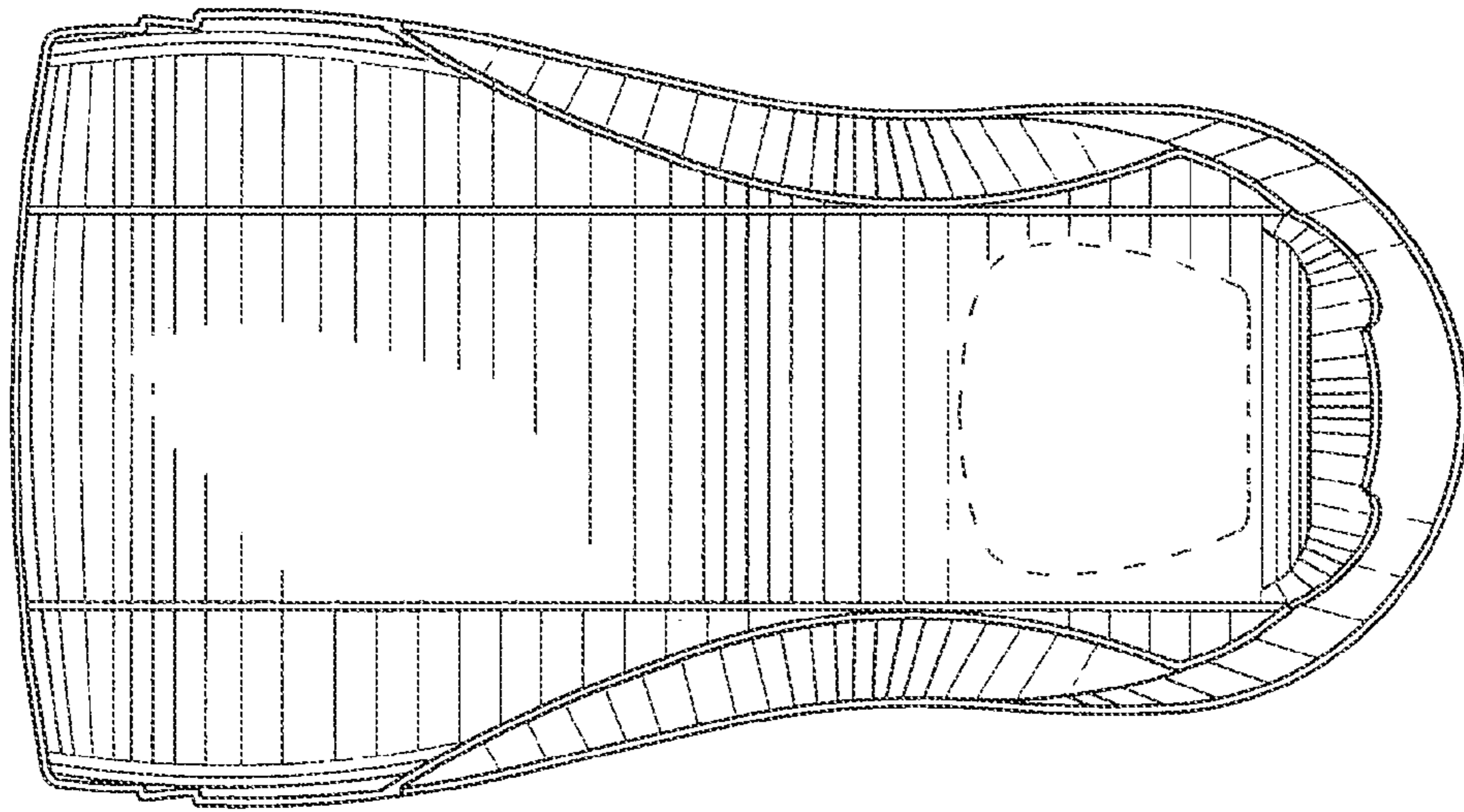

FIG. 5

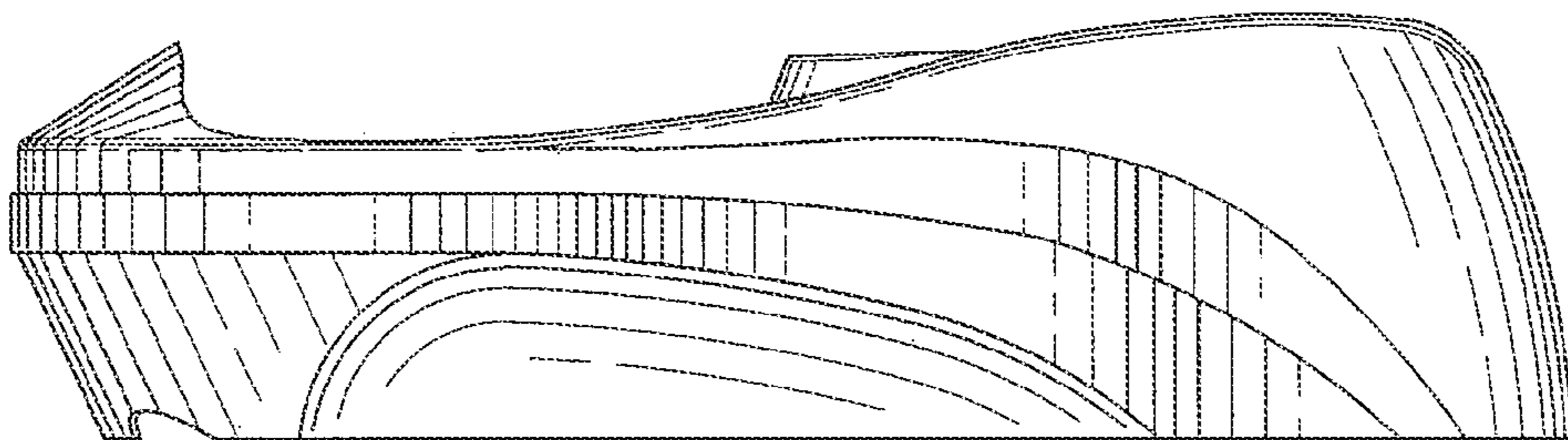

FIG. 6

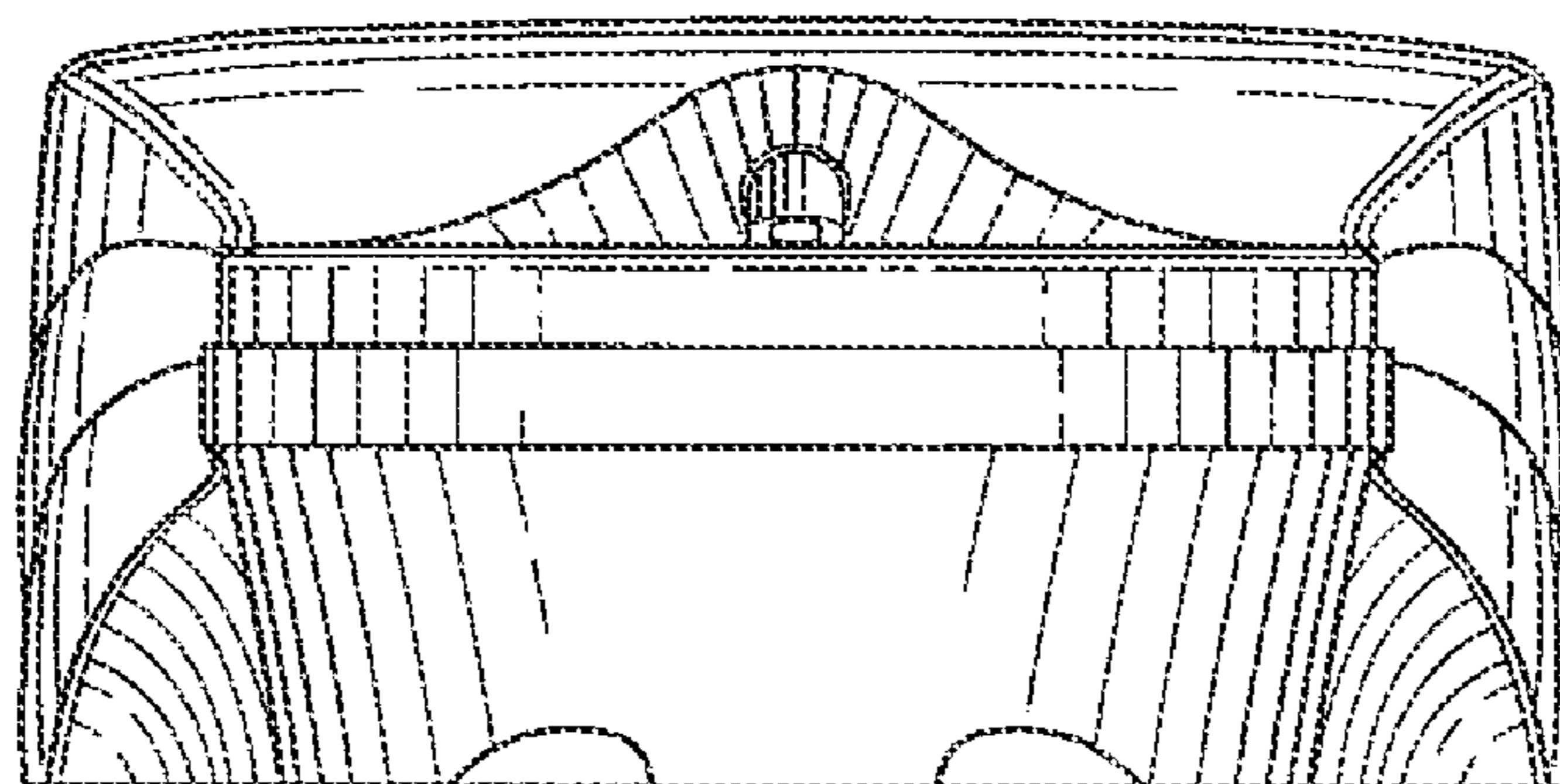

FIG. 7

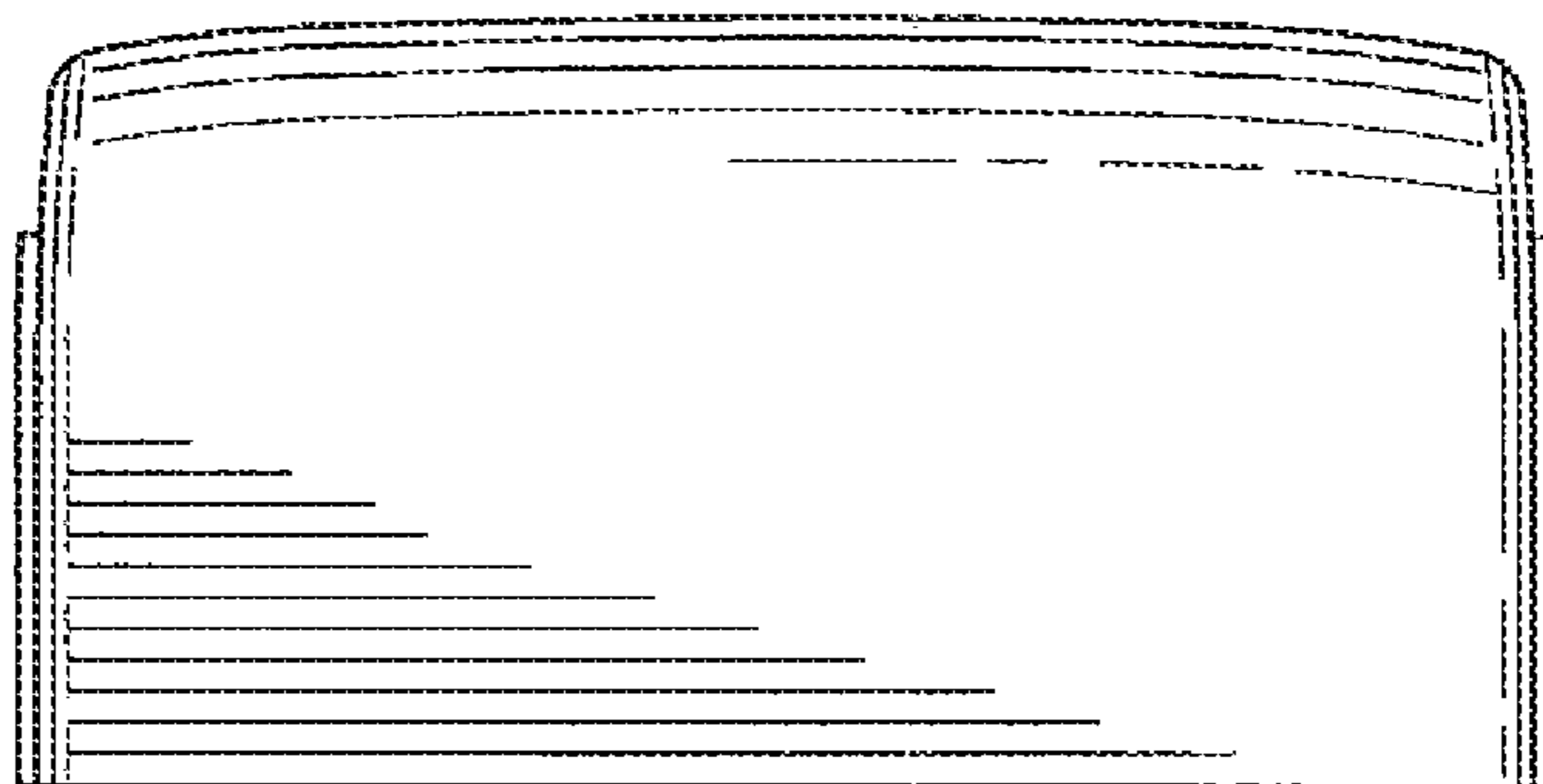

FIG. 8

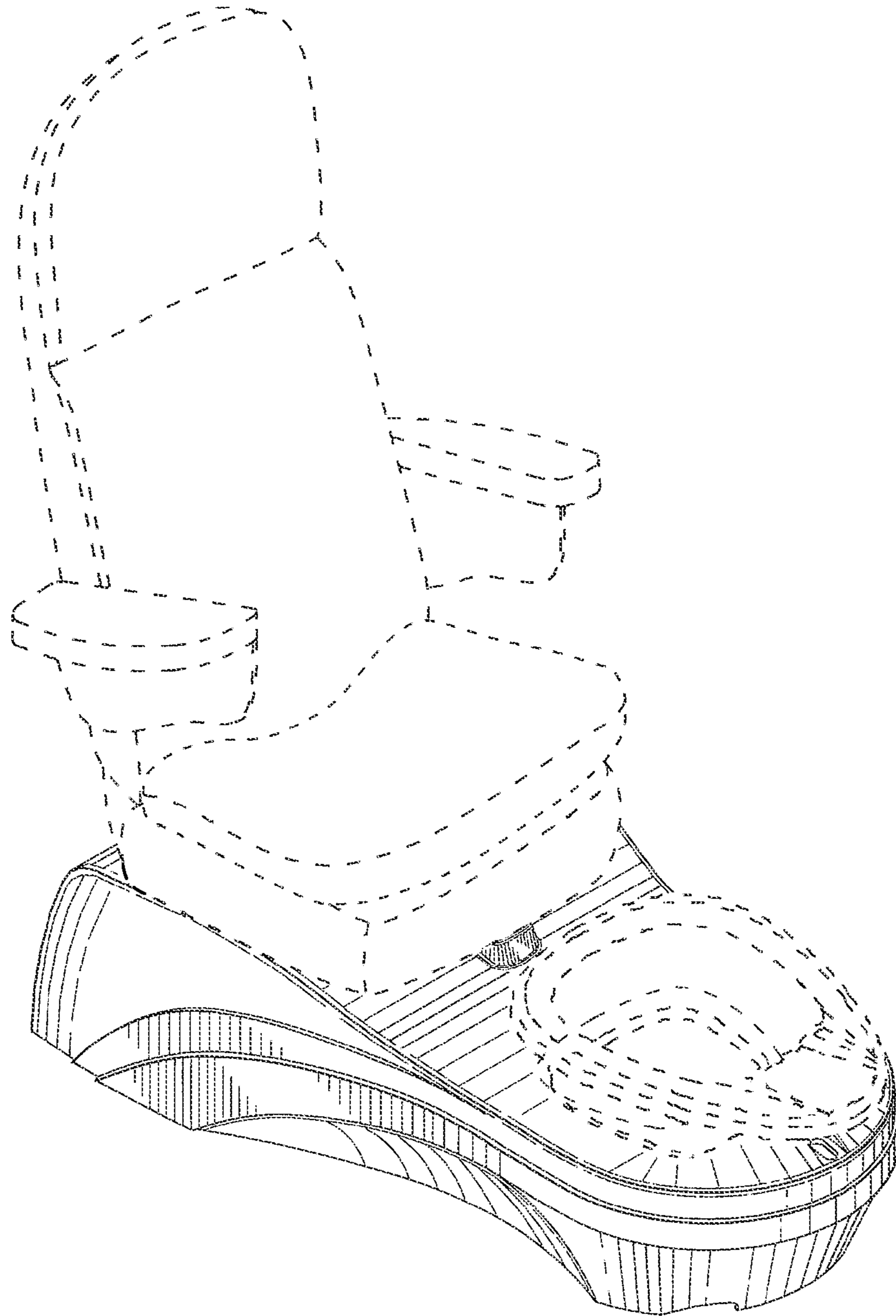

FIG. 9