



US00D590148S

(12) **United States Design Patent**
Lin

(10) **Patent No.:** **US D590,148 S**
(45) **Date of Patent:** **** Apr. 14, 2009**

(54) **CYLINDRICAL BAG**

(76) **Inventor:** **Che-Wen Lin**, P.O. Box No. 6-57,
Junghe, Taipei 235 (TW)

(**) **Term:** **14 Years**

(21) **Appl. No.:** **29/274,811**

(22) **Filed:** **May 29, 2007**

(51) **LOC (9) Cl.** **03-01**

(52) **U.S. Cl.** **D3/217**

(58) **Field of Classification Search** D3/216,
D3/217, 254, 273, 327, 284, 285, 287, 315,
D3/316, 221; 224/153, 259

See application file for complete search history.

(56) **References Cited**

U.S. PATENT DOCUMENTS

3,019,952	A *	2/1962	Brewster	294/142
D286,170	S *	10/1986	Colleuil	D21/662
D418,972	S *	1/2000	Gold	D3/217
D453,876	S *	2/2002	Moor et al.	D3/300
D469,608	S *	2/2003	Nevins	D3/300
6,592,012	B2 *	7/2003	Godshaw et al.	224/153
D506,865	S *	7/2005	Homsher et al.	D3/254
D517,801	S *	3/2006	Woo	D3/217
D520,136	S *	5/2006	Keller et al.	D24/131
7,374,071	B2 *	5/2008	Lavelle	224/153

* cited by examiner

Primary Examiner—Ian Simmons

Assistant Examiner—Anna J Burmeister

(57) **CLAIM**

The ornamental design for a cylindrical bag, as shown and described.

DESCRIPTION

FIG. 1 is a front perspective view of a cylindrical bag, shown in the closed condition;

FIG. 2 is a front elevational view thereof;

FIG. 3 is a rear elevational view thereof;

FIG. 4 is a left side elevational view thereof;

FIG. 5 is a right side elevational view thereof;

FIG. 6 is a top plan view thereof;

FIG. 7 is a bottom plan view thereof;

FIG. 8 is a front perspective view thereof, shown in the opened condition, revealing the shoulder straps;

FIG. 9 is a front perspective view thereof, shown in the opened condition, revealing the shoulder straps, with the front cover shown inserted into the article;

FIG. 10 is a front perspective view thereof, shown in the closed condition, with the shoulder straps on the exterior of the article; and,

FIG. 11 is a front elevational view thereof, shown in the closed condition, with the shoulder straps on the exterior of the article.

The broken lines depicting the human form shown in the FIG. 9 drawing view are for illustrative purposes only and form no part of the claimed design.

1 Claim, 11 Drawing Sheets

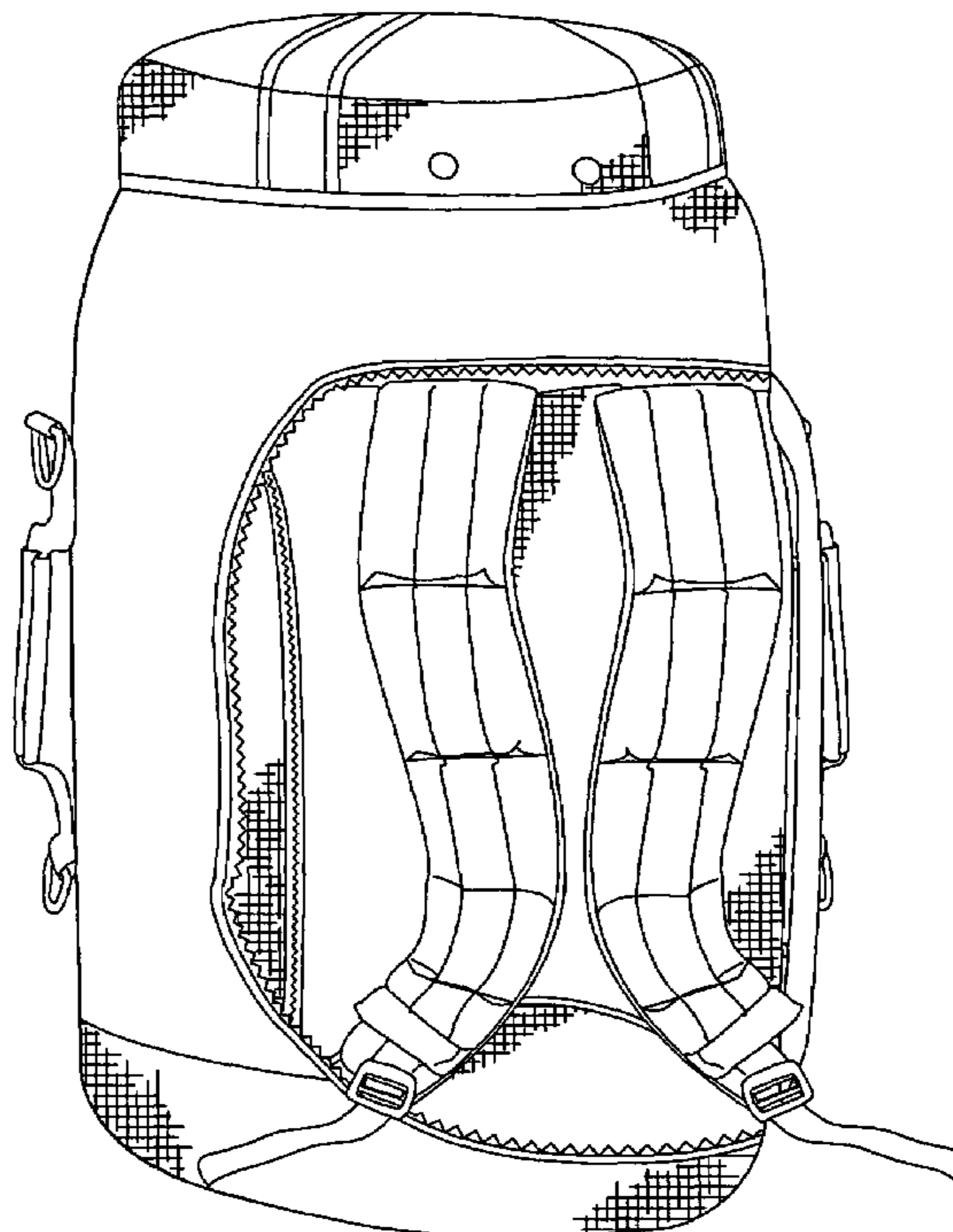
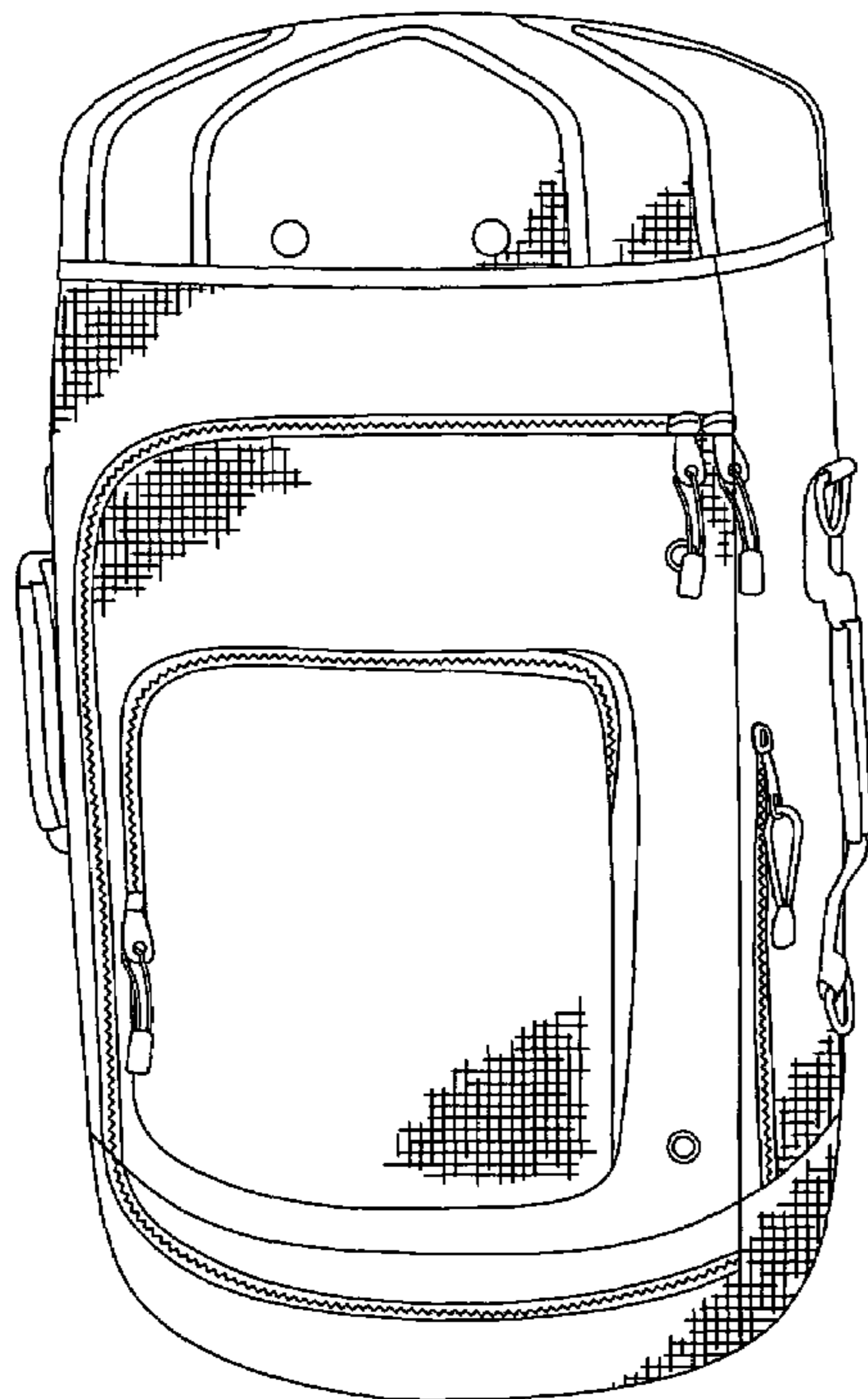

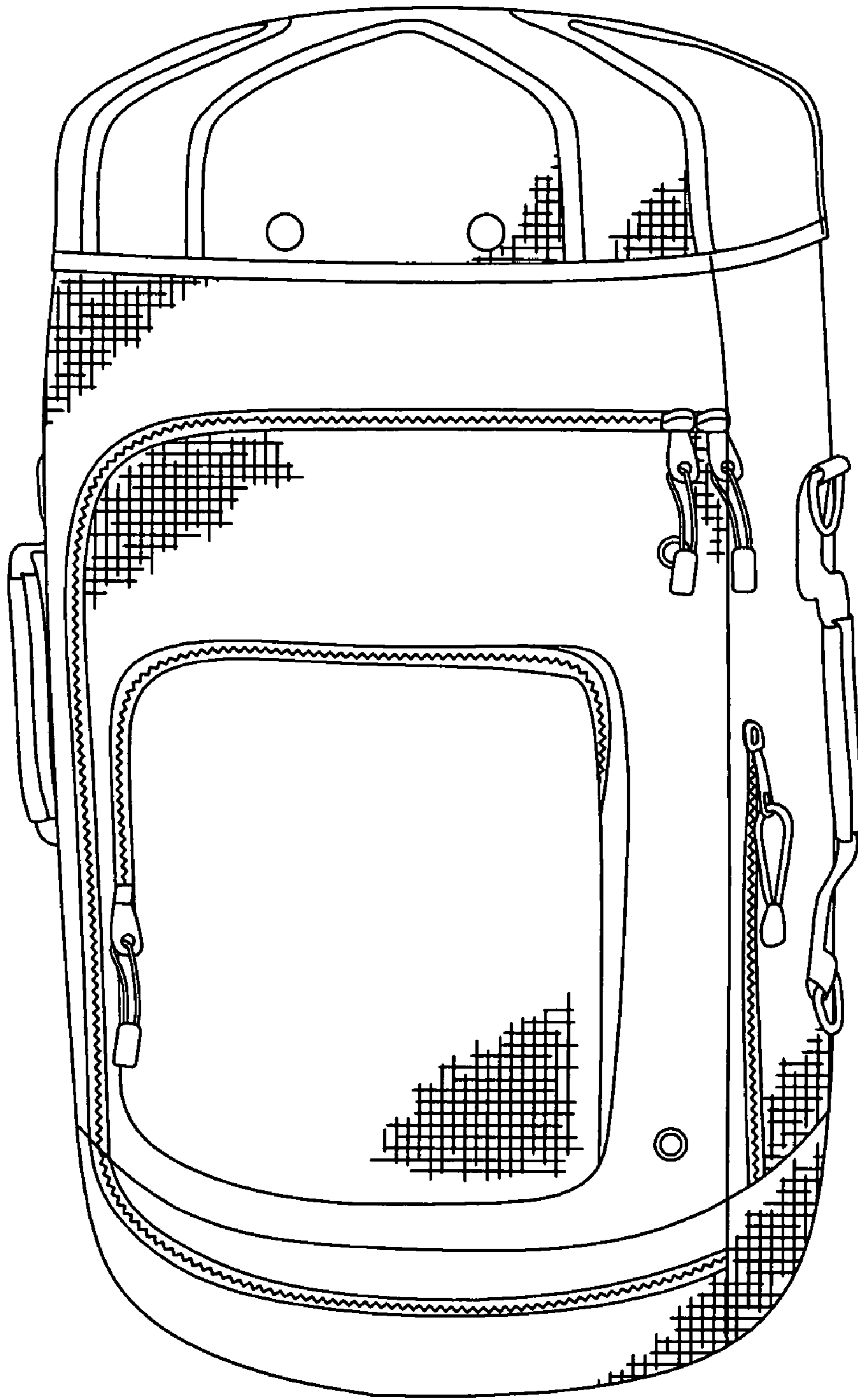

FIG. 1

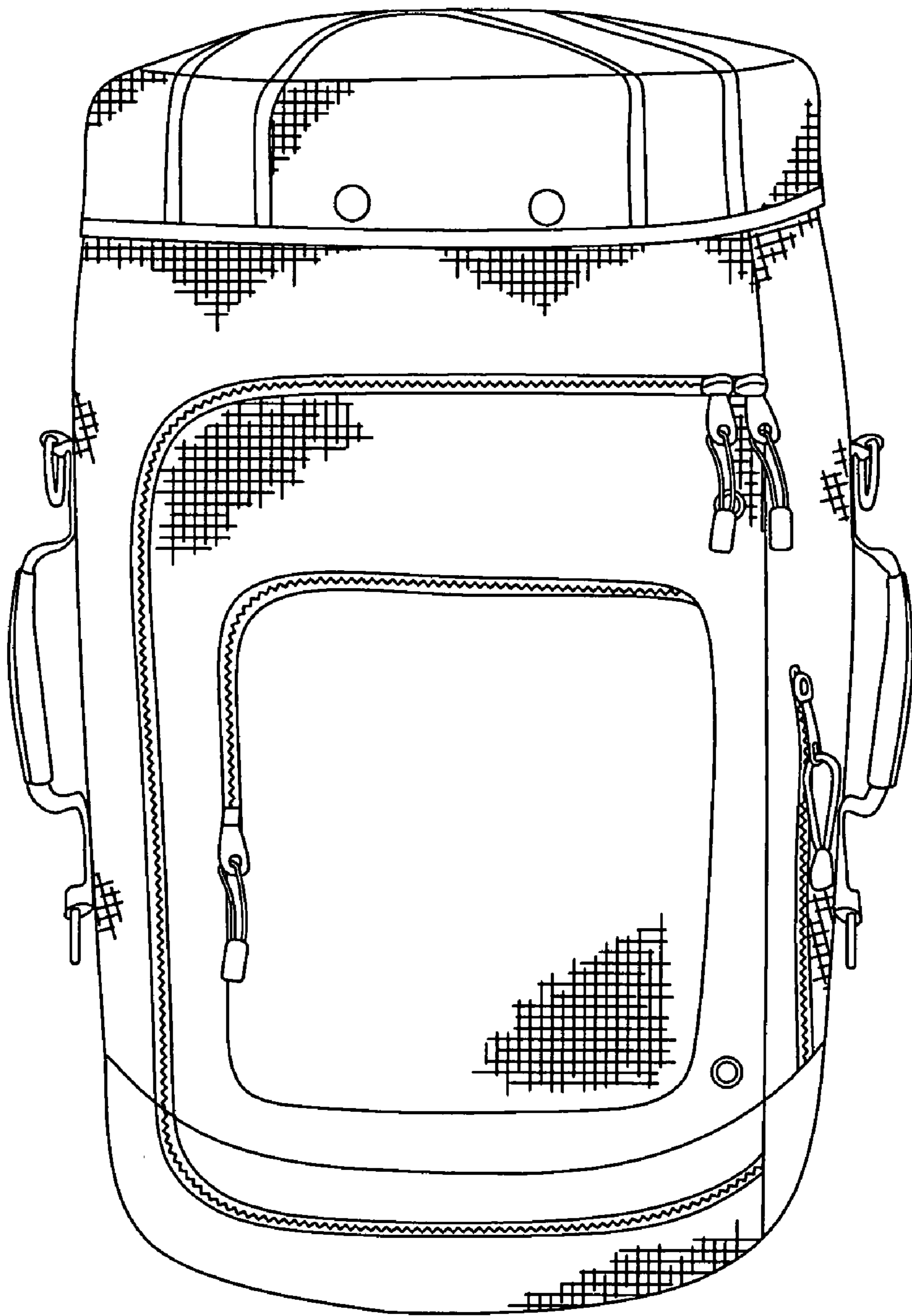

FIG.2

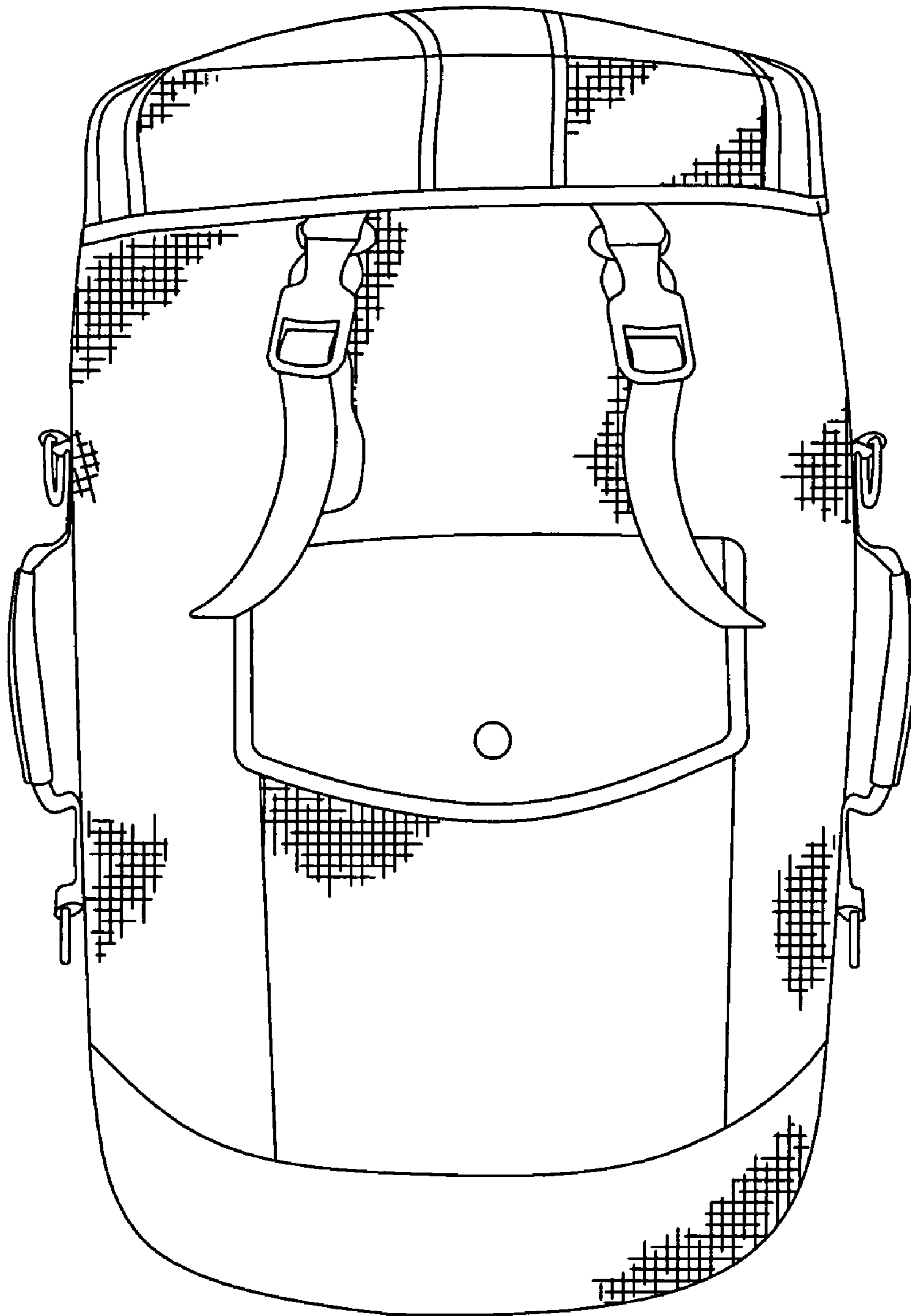

FIG.3

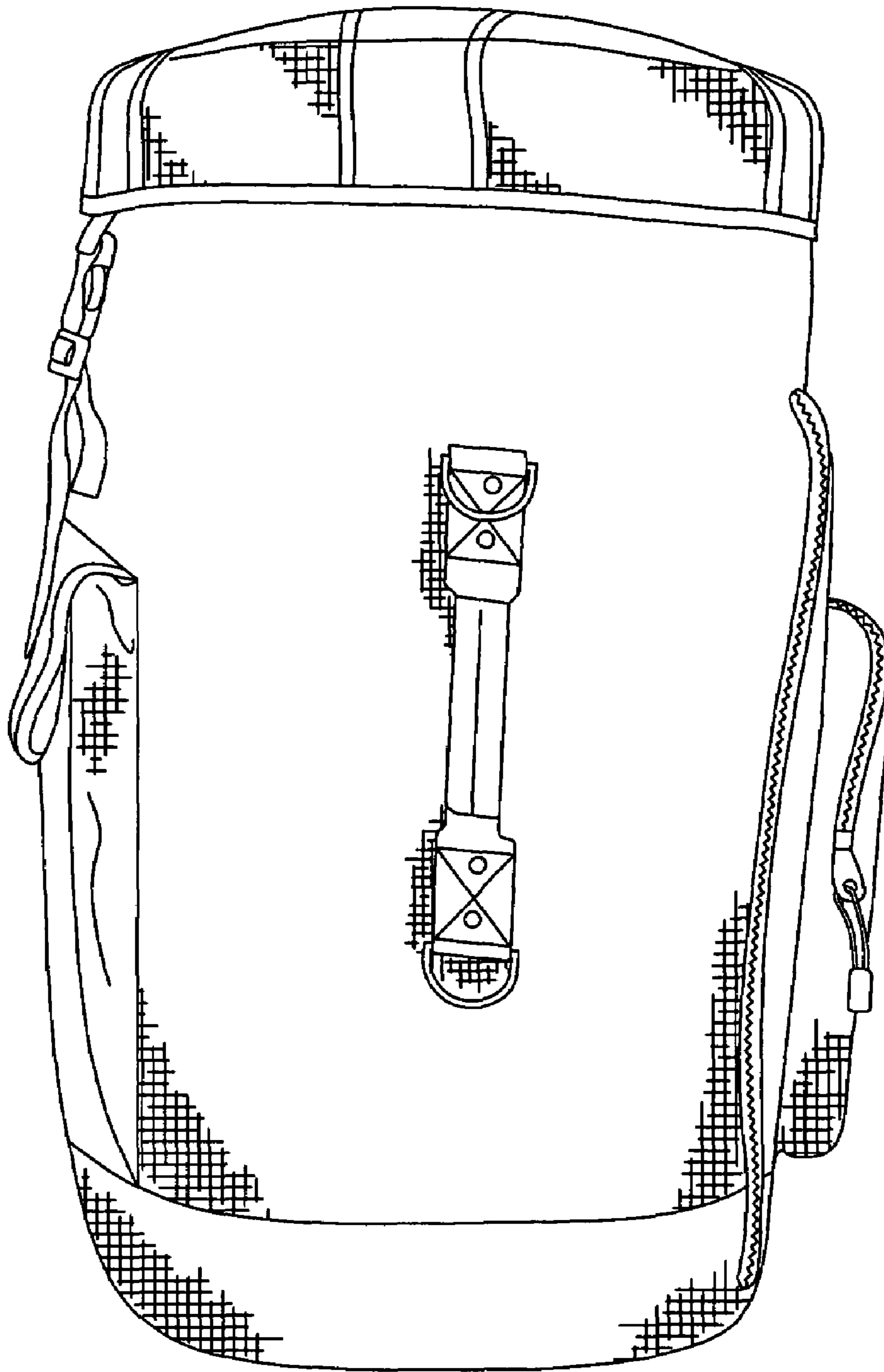

FIG.4

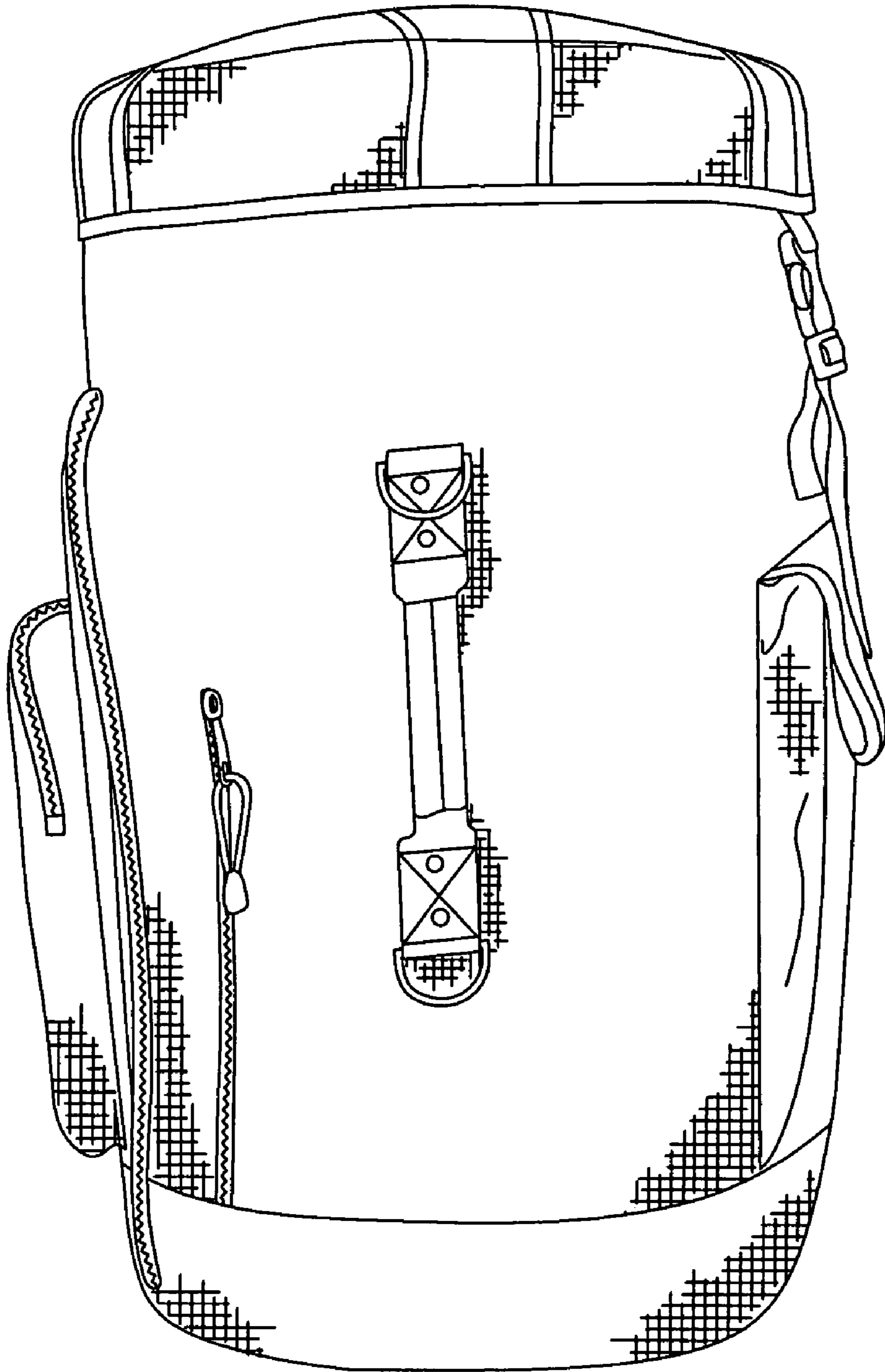

FIG. 5

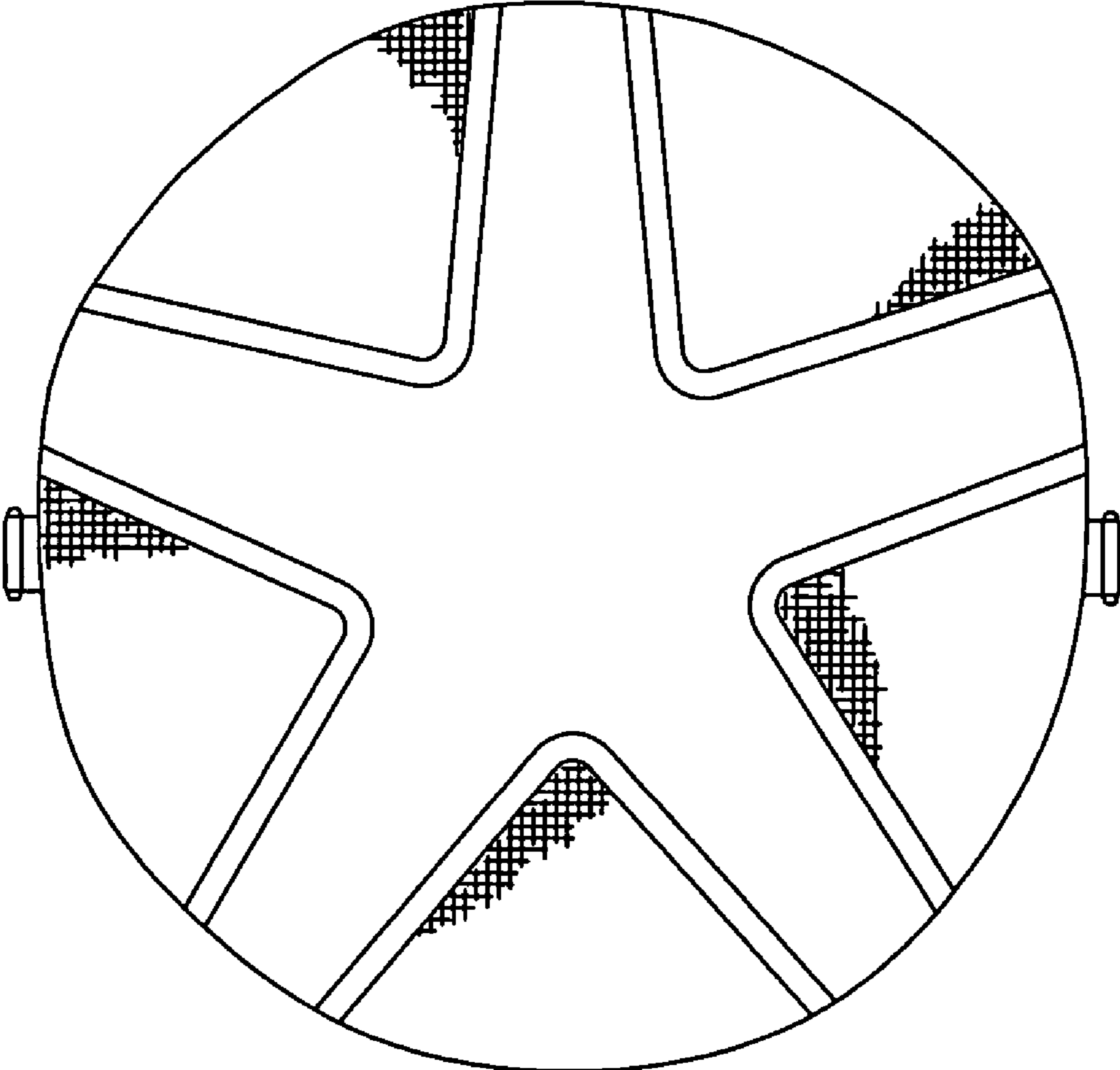

FIG.6

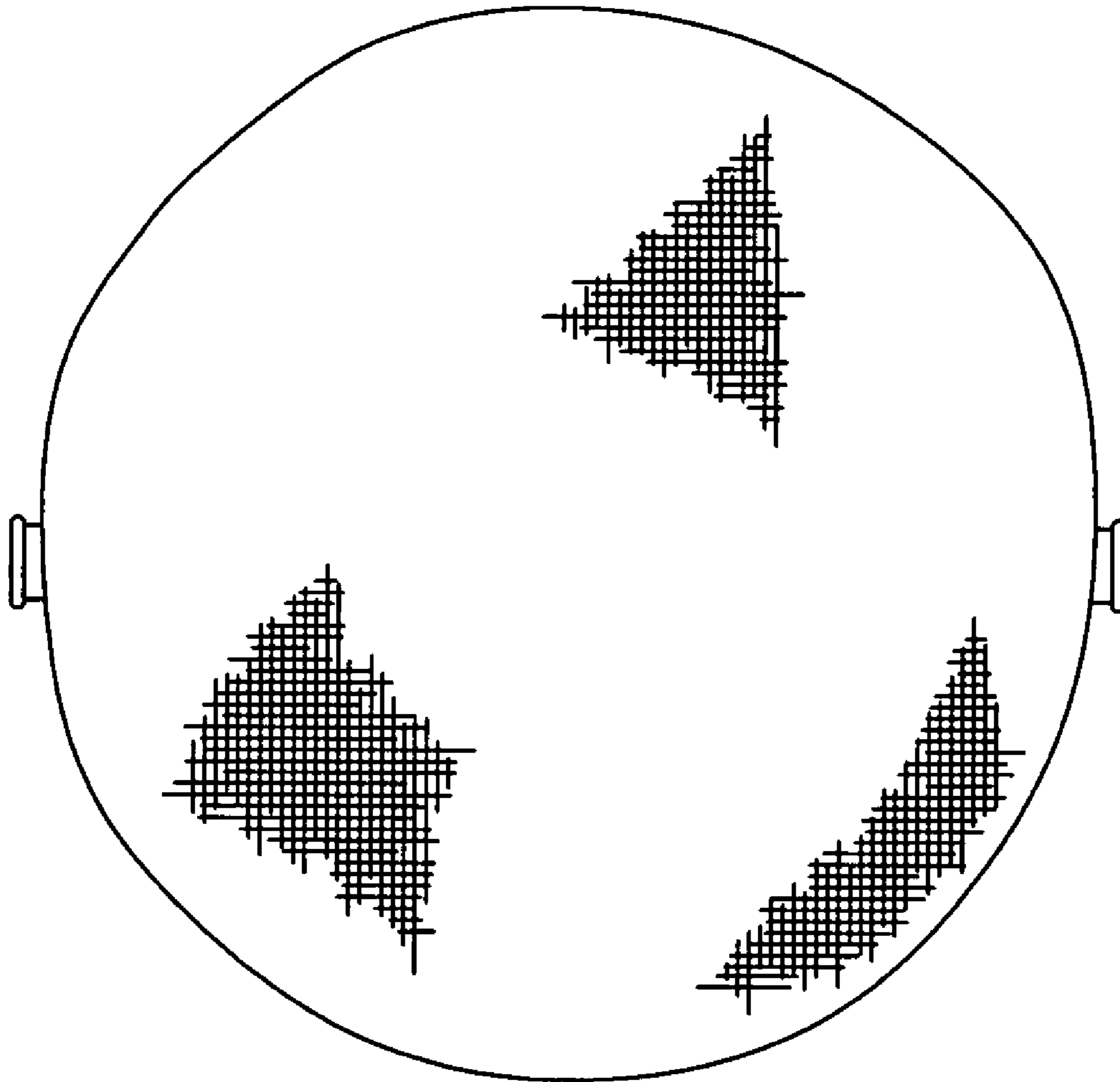

FIG. 7

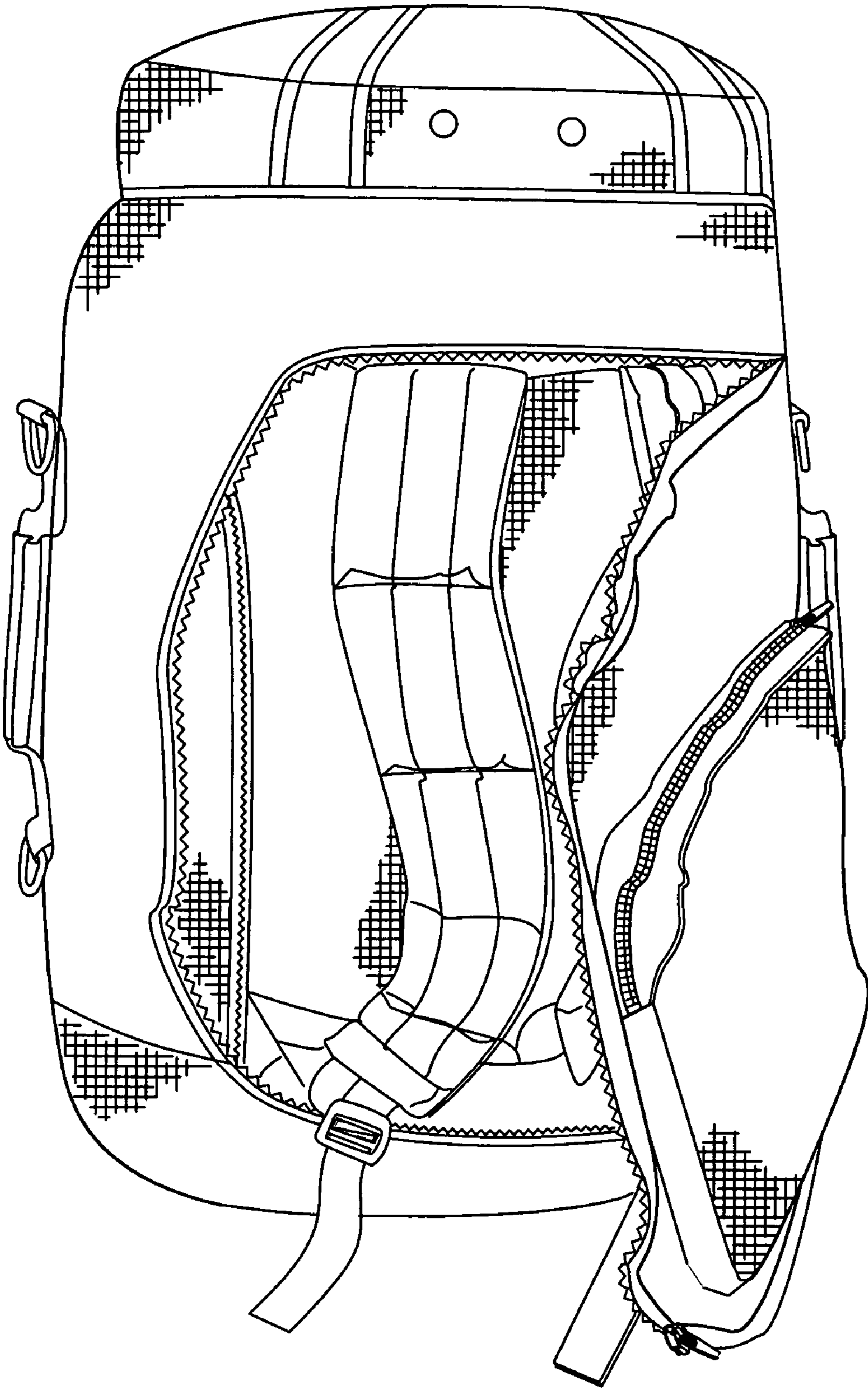

FIG. 8

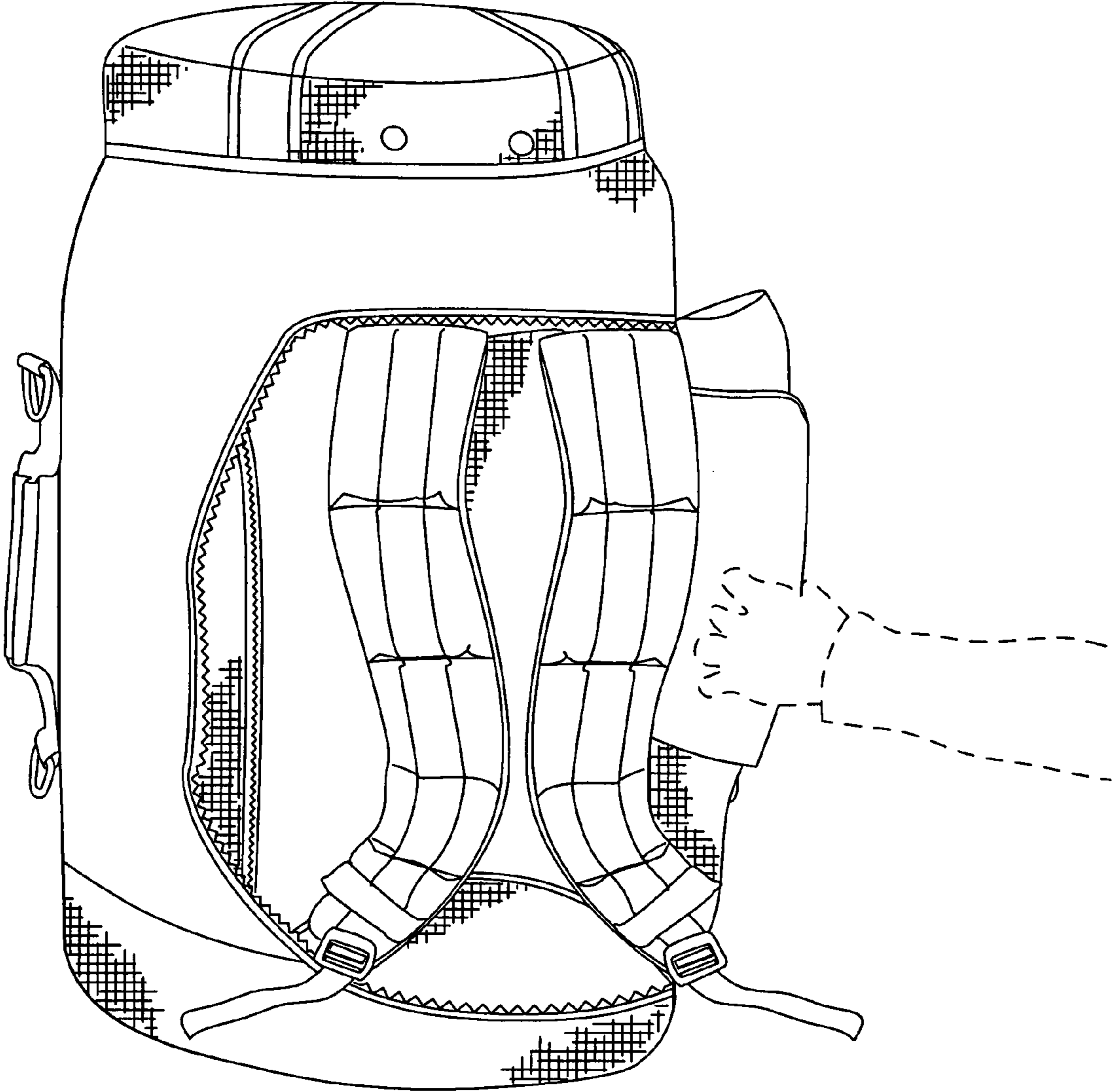

FIG.9

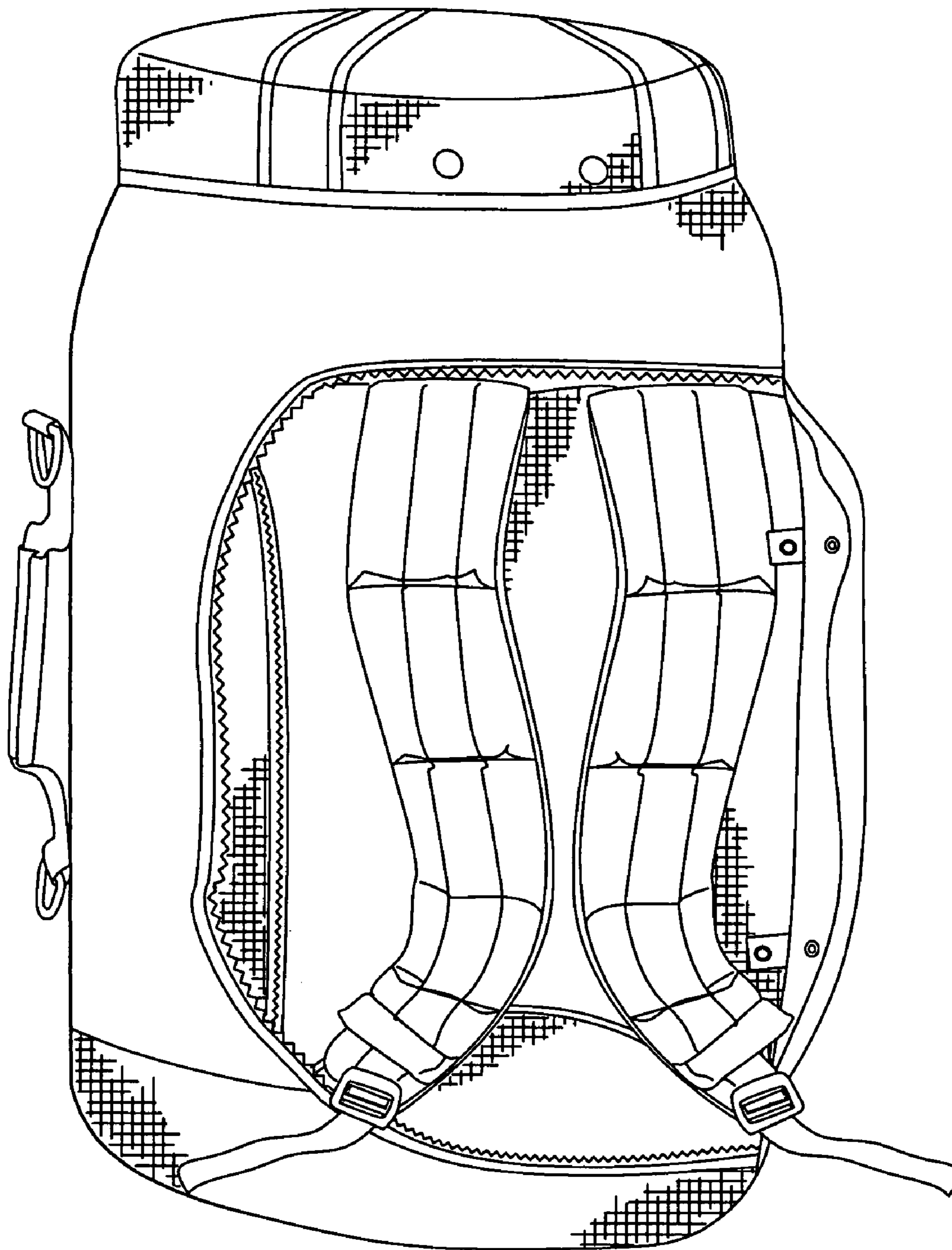

FIG. 10

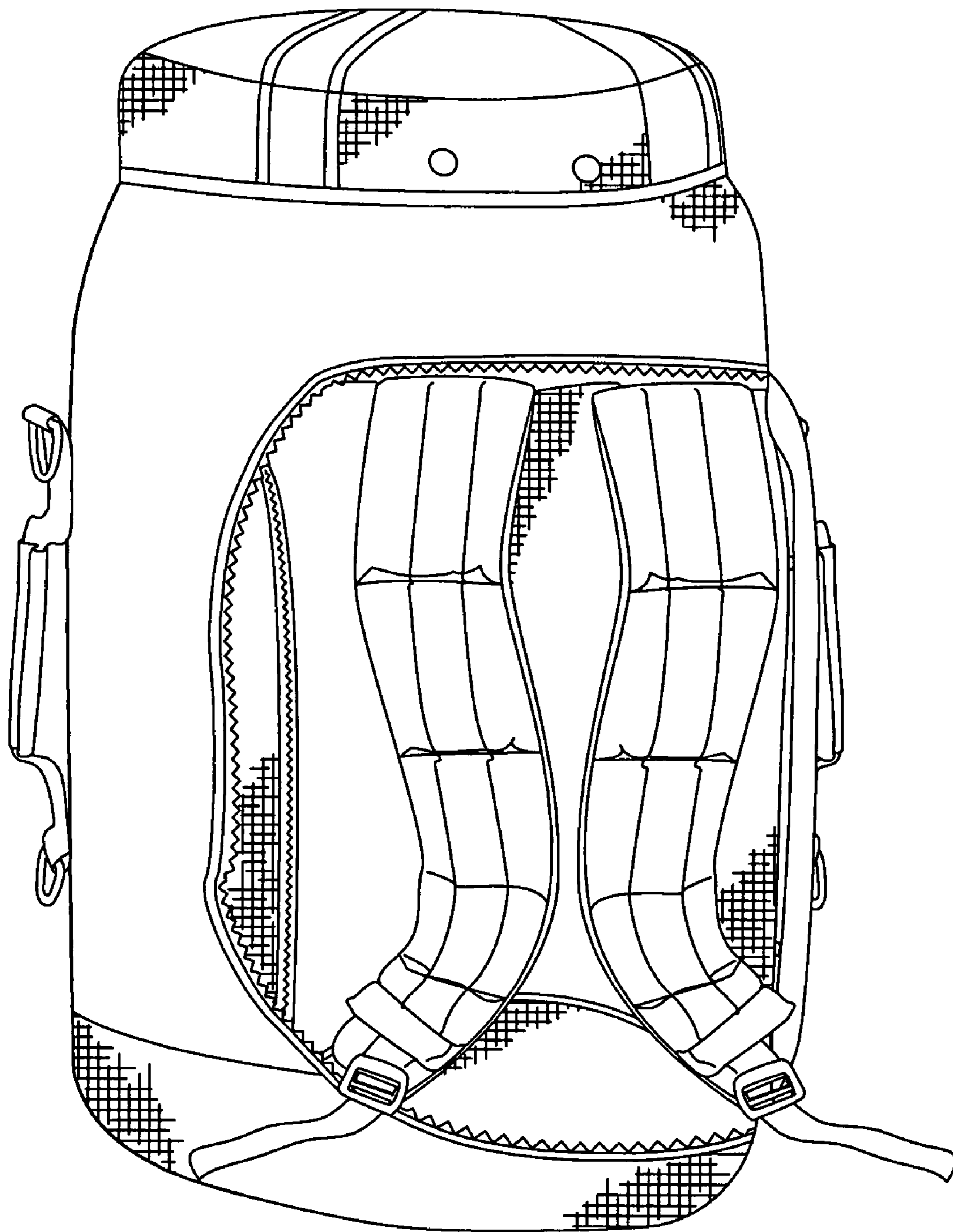

FIG. 11