



US00D590106S

(12) **United States Design Patent**
Nimmons

(10) **Patent No.:** **US D590,106 S**

(45) **Date of Patent:** **** Apr. 7, 2009**

(54) **FACEGUARD**

(75) Inventor: **Kenneth W. Nimmons**, Litchfield, IL (US)

(73) Assignee: **Melas, Inc.**, Litchfield, IL (US)

(**) Term: **14 Years**

(21) Appl. No.: **29/292,936**

(22) Filed: **Oct. 31, 2007**

(51) **LOC (9) Cl.** **29-02**

(52) **U.S. Cl.** **D29/122**

(58) **Field of Classification Search** D29/102-112, D29/122; D24/110.1-110.4, 191; 267/142-146, 267/113, 64.13; 2/410-414, 416, 422-425, 2/9, 10, 206, 427, 429, 5, 6.3, 6.5, 6.7; 128/857-858
See application file for complete search history.

(56) **References Cited**

U.S. PATENT DOCUMENTS

1,522,952 A	1/1925	Goldsmith
1,892,943 A	1/1933	Geyer
2,140,716 A	12/1938	Pryale
2,296,335 A	9/1942	Brady
2,969,546 A	1/1961	Morgan, Jr.
3,166,761 A	1/1965	Strohm
3,186,004 A	6/1965	Carlini
3,263,236 A	8/1966	Humphrey
3,274,613 A	9/1966	Sowle
3,548,409 A	12/1970	Aileo
3,609,764 A	10/1971	Morgan
3,761,959 A	10/1973	Dunning
3,882,547 A	5/1975	Morgan
3,897,598 A	8/1975	Bednarczuk et al.
4,028,743 A	6/1977	Christensen
4,075,714 A	2/1978	Ryder et al.
4,086,664 A	5/1978	Humphrey et al.

(Continued)

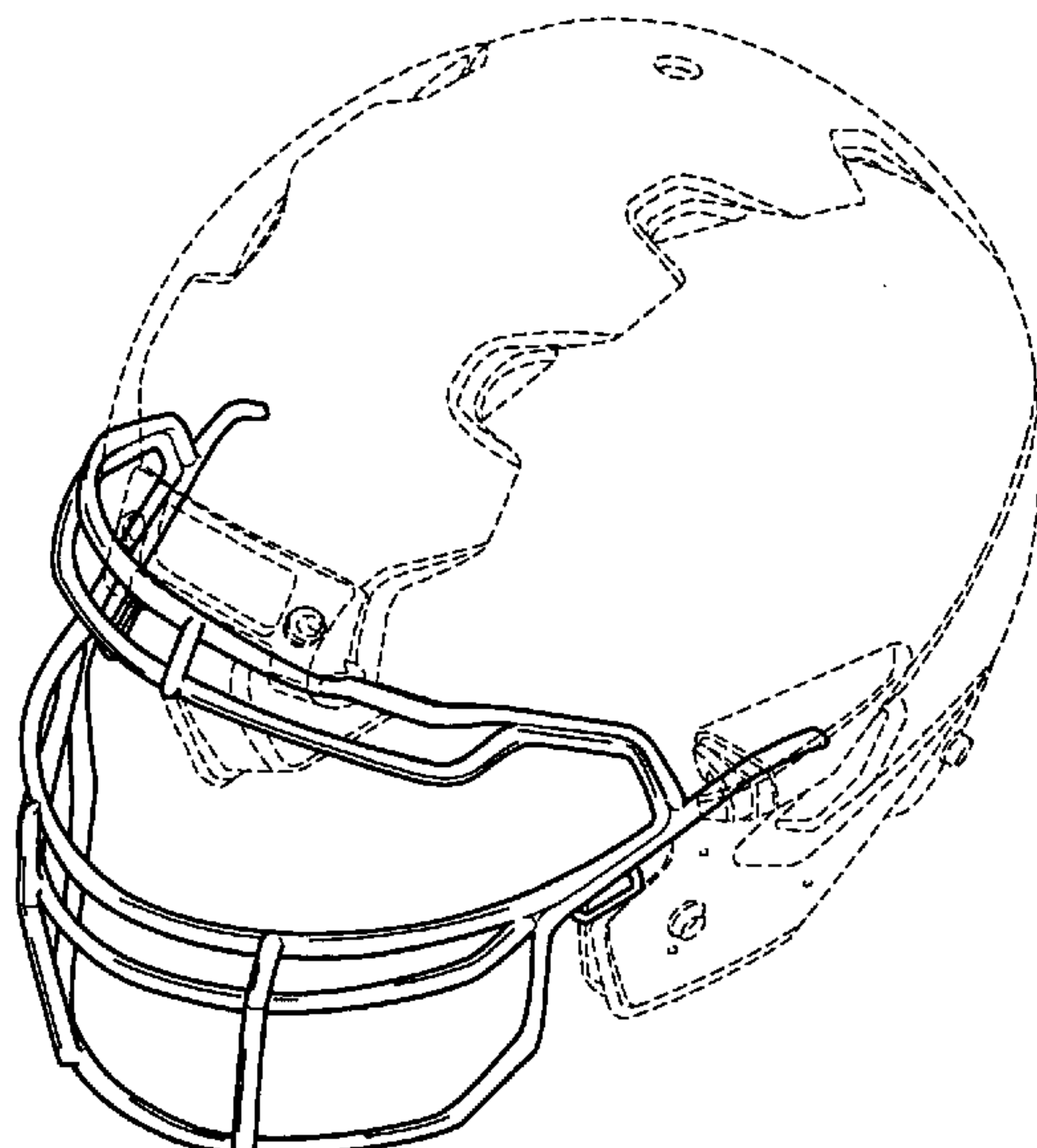

OTHER PUBLICATIONS

Face-off Lacrosse Yearbook, 2003, vol. 10, Spring 2003, three pages.

(Continued)

Primary Examiner—Ruth McInroy

(74) *Attorney, Agent, or Firm*—Brinks Hofer Gilson & Lione

(57) **CLAIM**

I claim the ornamental design for a faceguard, as shown and described.

DESCRIPTION

FIG. 1 is a perspective view of a first embodiment of a new design of a faceguard;

FIG. 2 is a front view of the design shown in FIG. 1;

FIG. 3 is a rear view of the design shown in FIG. 1;

FIG. 4 is a right side view of the design shown in FIG. 1;

FIG. 5 is a left side view of the design shown in FIG. 1;

FIG. 6 is a top view of the design shown in FIG. 1;

FIG. 7 is a bottom view of the design shown in FIG. 1;

FIG. 8 is a perspective view of a second embodiment of a new design of a faceguard;

FIG. 9 is a front view of the design shown in FIG. 8;

FIG. 10 is a rear view of the design shown in FIG. 8;

FIG. 11 is a right side view of the design shown in FIG. 8;

FIG. 12 is a left side view of the design shown in FIG. 8;

FIG. 13 is a top view of the design shown in FIG. 8; and,

FIG. 14 is a bottom view of the design shown in FIG. 8.

The ornamental designs which are claimed are shown in solid lines in the drawings. Any broken lines in the drawings are for illustrative purposes only and form no part of the claimed designs.

1 Claim, 8 Drawing Sheets

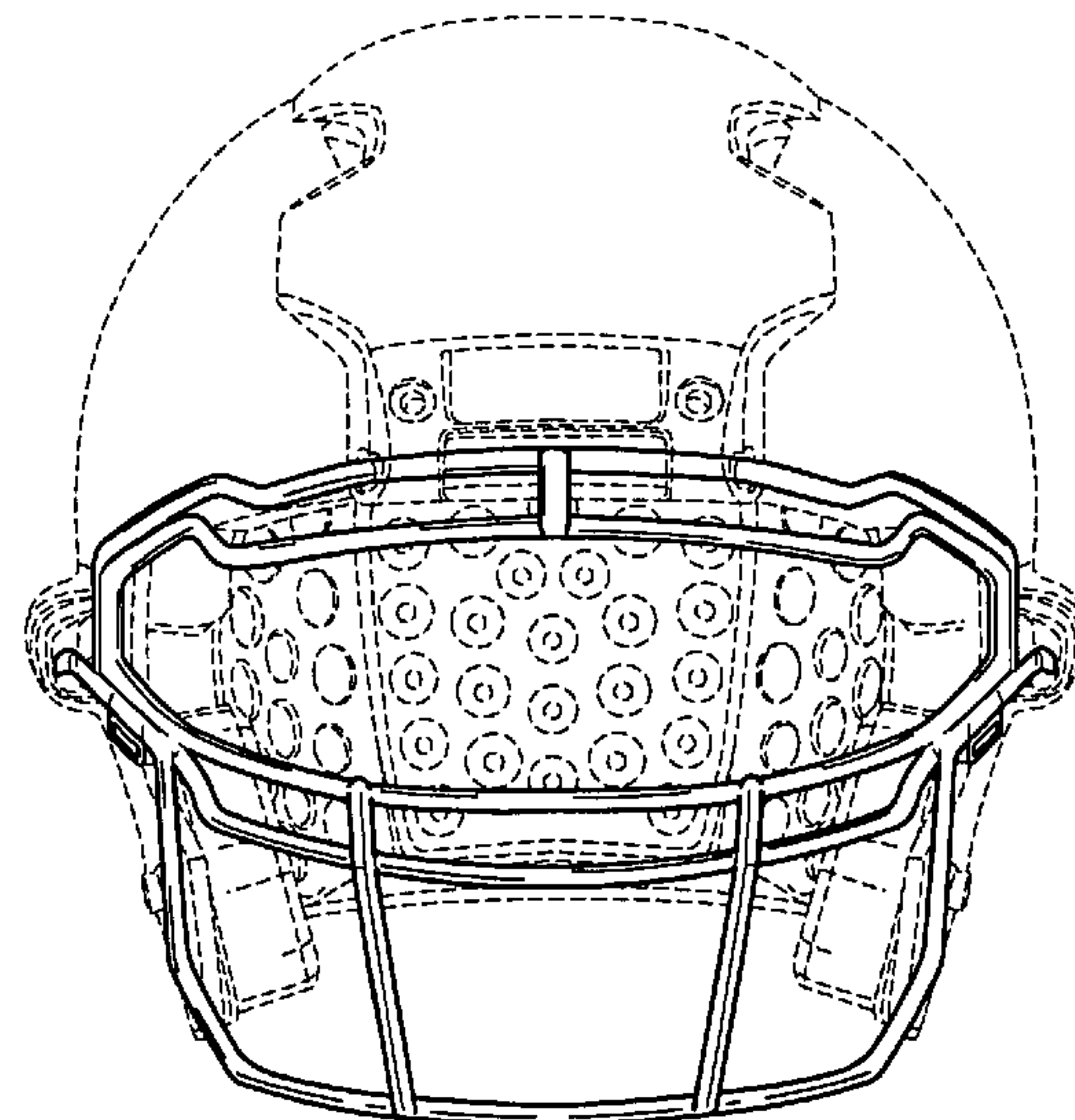

US D590,106 S

Page 2

U.S. PATENT DOCUMENTS

D249,397 S *	9/1978	Humphrey et al.	D29/111	D408,236 S	4/1999	Rennick	
4,233,687 A	11/1980	Lancellotti		5,963,990 A	10/1999	White	
4,287,613 A	9/1981	Schulz		6,128,786 A	10/2000	Maddux et al.	
D267,287 S	12/1982	Gooding		6,189,156 B1	2/2001	Loiars	
4,363,140 A	12/1982	Correale		6,219,850 B1	4/2001	Halstead et al.	
4,370,759 A	2/1983	Zide		6,226,801 B1	5/2001	Alexander et al.	
4,390,995 A	7/1983	Walck		6,370,699 B1	4/2002	Halstead et al.	
4,404,690 A	9/1983	Farquharson		D459,032 S	6/2002	Gatellet	
4,633,531 A	1/1987	Nimmons		D459,554 S	6/2002	Gatellet	
4,646,368 A	3/1987	Infusino et al.		6,438,762 B1	8/2002	Jenkins	
D289,568 S *	4/1987	Nimmons	D29/111	D463,885 S *	10/2002	Burns	D29/111
D289,569 S *	4/1987	Nimmons	D29/111	D465,067 S	10/2002	Ide et al.	
4,692,947 A	9/1987	Black et al.		6,481,024 B1	11/2002	Grant	
4,744,107 A	5/1988	Föhl		D466,651 S	12/2002	Halstead et al.	
D298,868 S *	12/1988	Klindt	D29/111	D475,486 S	6/2003	Ide et al.	
4,794,652 A	1/1989	Piech von Planta et al.		D508,298 S *	8/2005	Bernacchi et al.	D29/111
4,831,668 A	5/1989	Schulz		6,934,971 B2	8/2005	Ide et al.	
4,837,866 A	6/1989	Rector et al.		D517,250 S *	3/2006	Polstein	D29/122
4,853,980 A	8/1989	Zarotti		7,036,151 B2	5/2006	Ide et al.	
4,903,346 A	2/1990	Reddemann et al.		D528,705 S	9/2006	Ida et al.	
4,916,759 A	4/1990	Arai		7,146,652 B2	12/2006	Ide et al.	
4,947,490 A	8/1990	Hayden		7,240,376 B2	7/2007	Ide et al.	
5,014,365 A	5/1991	Schulz		2002/0104533 A1	8/2002	Kalhok et al.	
5,035,009 A	7/1991	Wingo, Jr. et al.		2007/0192944 A1	8/2007	Ide et al.	
5,142,700 A	8/1992	Reed					
D332,507 S	1/1993	Anderson et al.					
5,175,889 A	1/1993	Infusino					
5,177,816 A	1/1993	Schmidt et al.					
5,263,203 A	11/1993	Kraemer et al.					
5,267,353 A	12/1993	Milligan					
5,293,649 A	3/1994	Corpus					
D350,710 S	9/1994	Keiffer					
D358,686 S *	5/1995	Kraemer	D29/111				
D364,487 S	11/1995	Tutton et al.					
D381,127 S *	7/1997	Rothwell	D29/111				
D383,953 S	9/1997	DeFilippo					
5,732,414 A	3/1998	Monica					

OTHER PUBLICATIONS

Photographs of four (4) helmets, labeled A1-A6, B1-B5, C1-C7, D1-D5, E1-E3, and F1-F5, eighteen pages, Atty Morgan verified date: Apr. 20, 2005.

U.S. Appl. No. 11/981,171, filed Oct. 31, 2007, Nimmons et al.

U.S. Appl. No. 29/292,931, filed Oct. 31, 2007, Nimmons.

U.S. Appl. No. 29/292,922, filed Oct. 31, 2007, Nimmons.

U.S. Appl. No. 29/294,838, filed Jan. 29, 2008, Nimmons et al.

U.S. Appl. No. 29/294,839, filed Jan. 29, 2008, Nimmons et al.

U.S. Appl. No. 29/294,848, filed Jan. 29, 2008, Nimmons et al.

U.S. Appl. No. 29/294,857, filed Jan. 29, 2008, Nimmons et al.

* cited by examiner

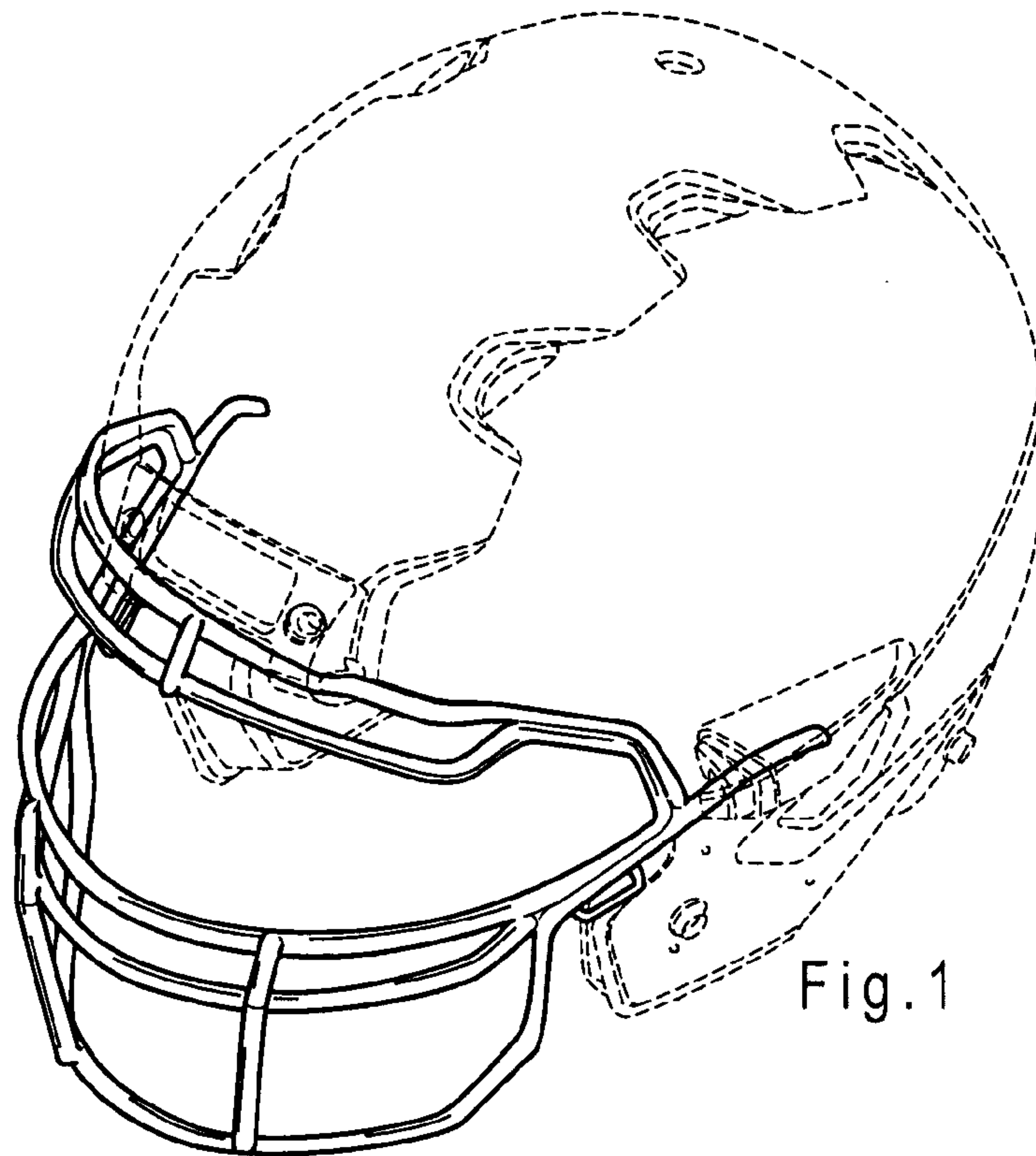

Fig. 1

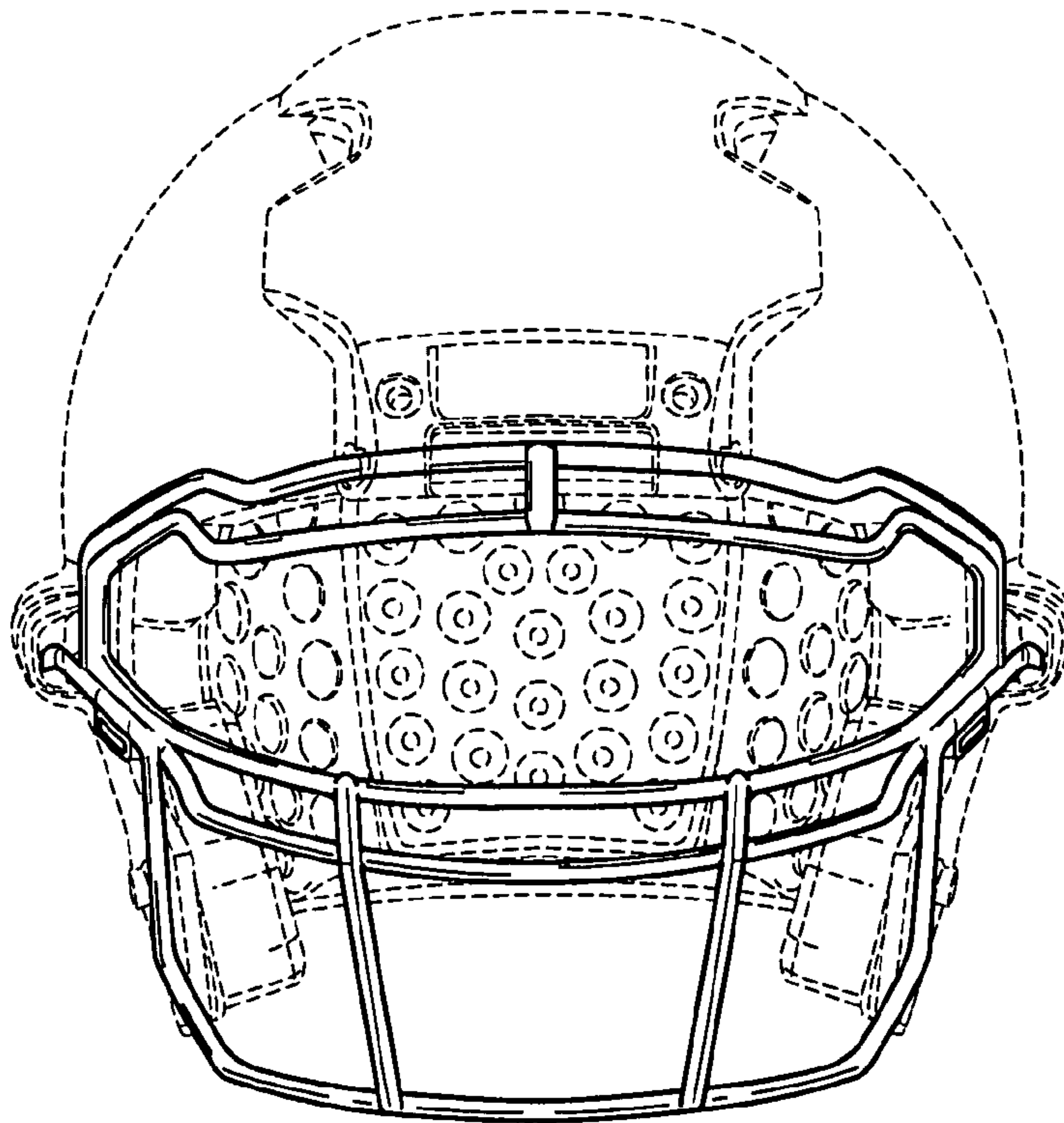

Fig. 2

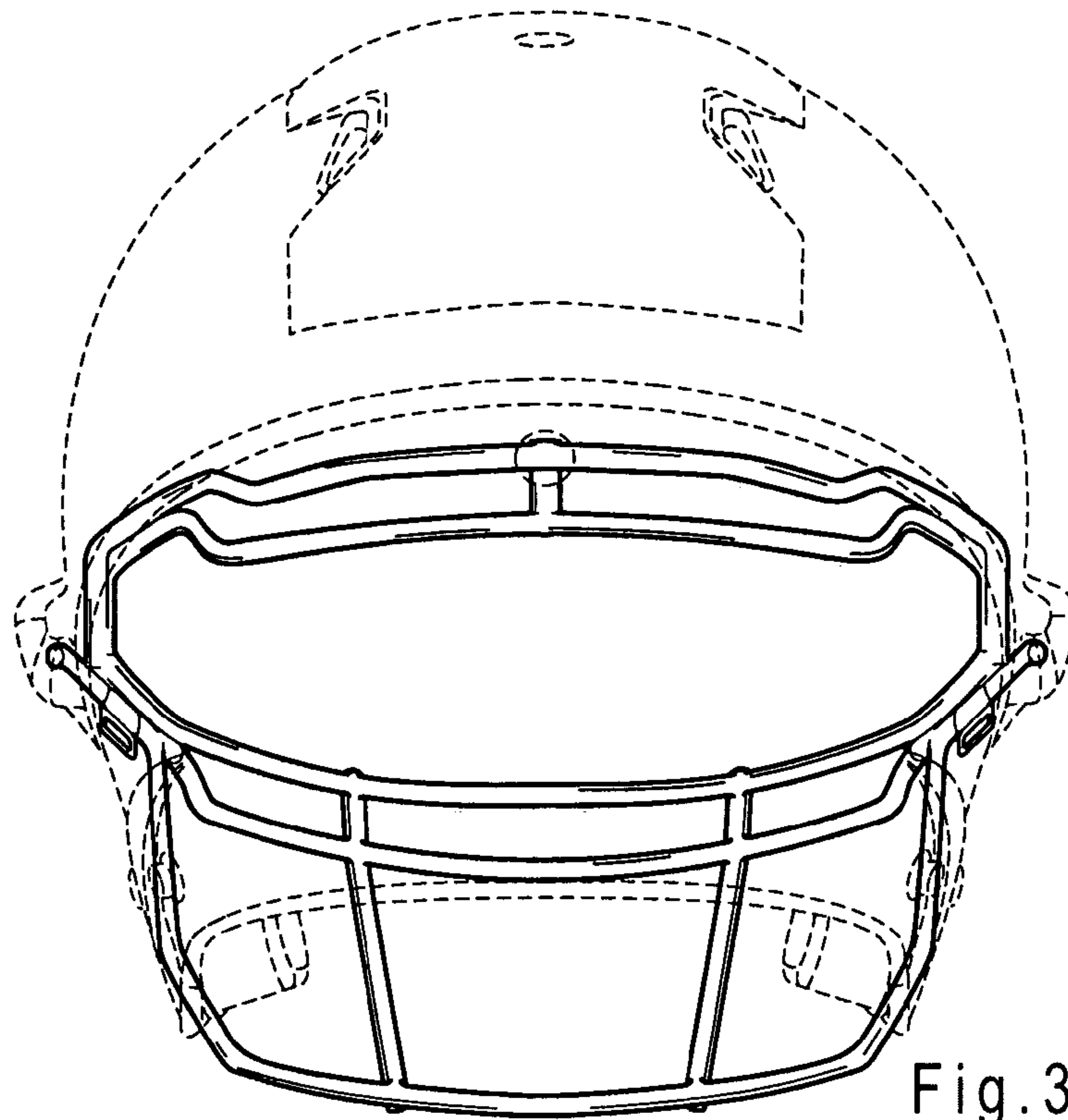

Fig. 3

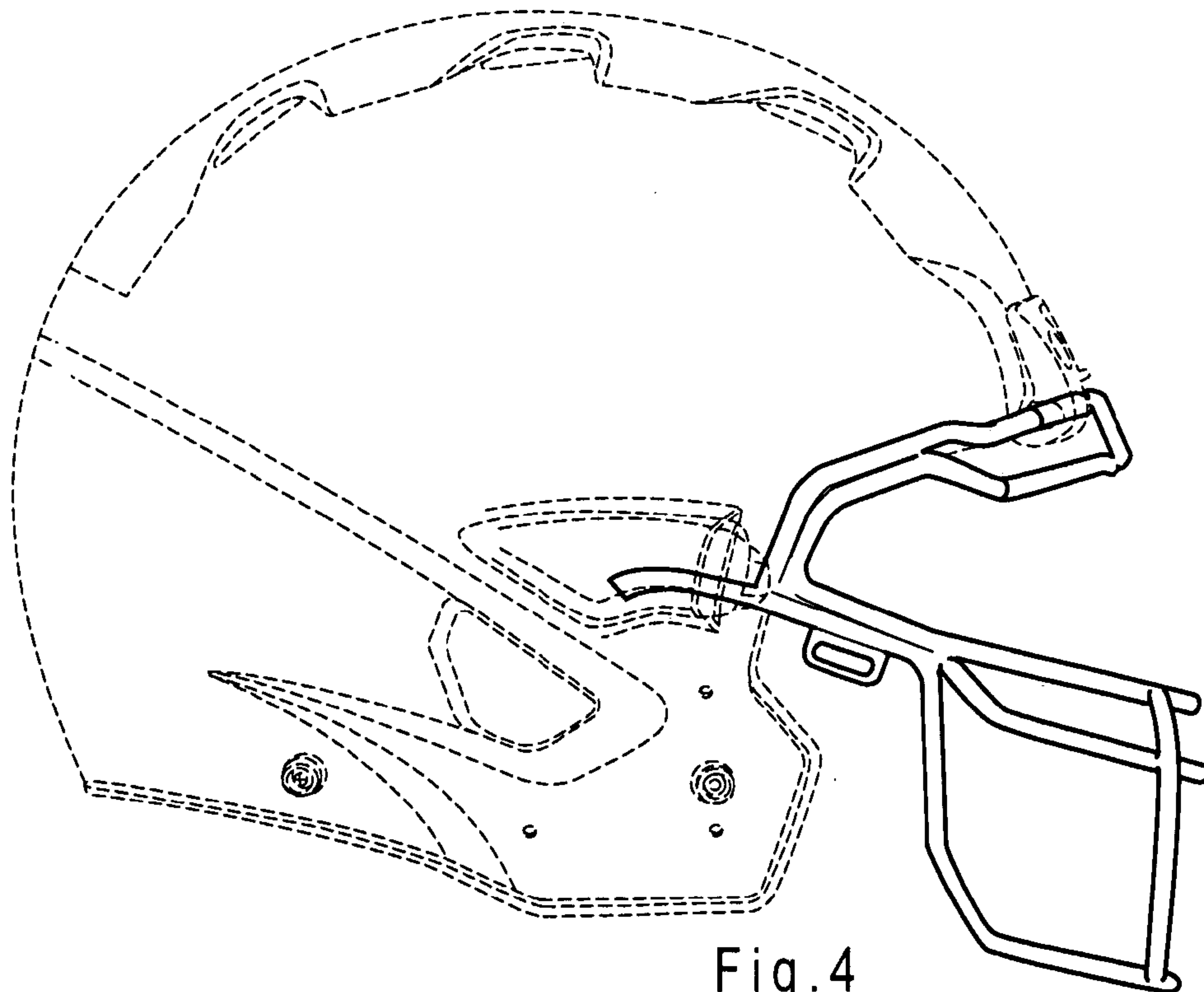

Fig. 4

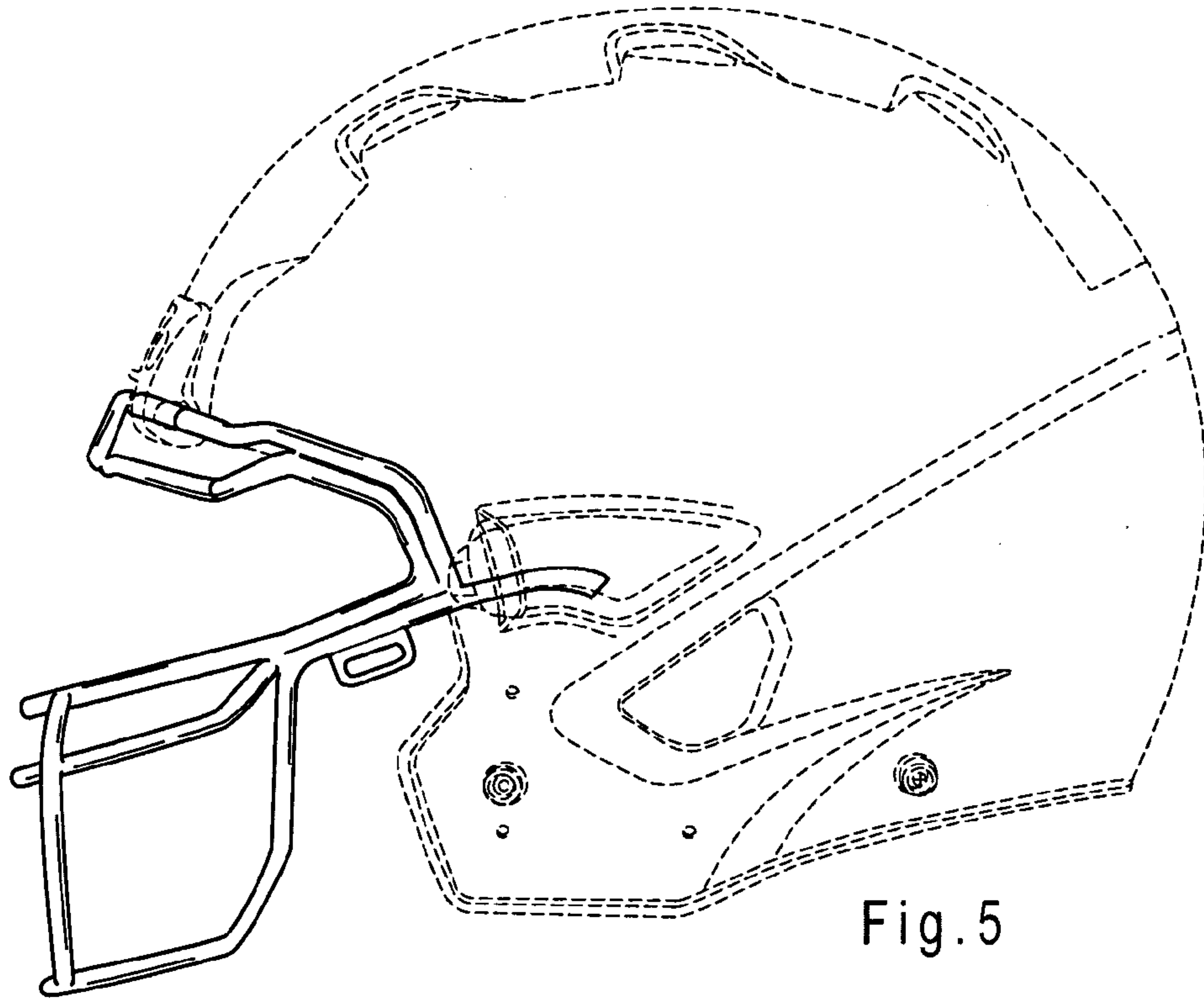

Fig. 5

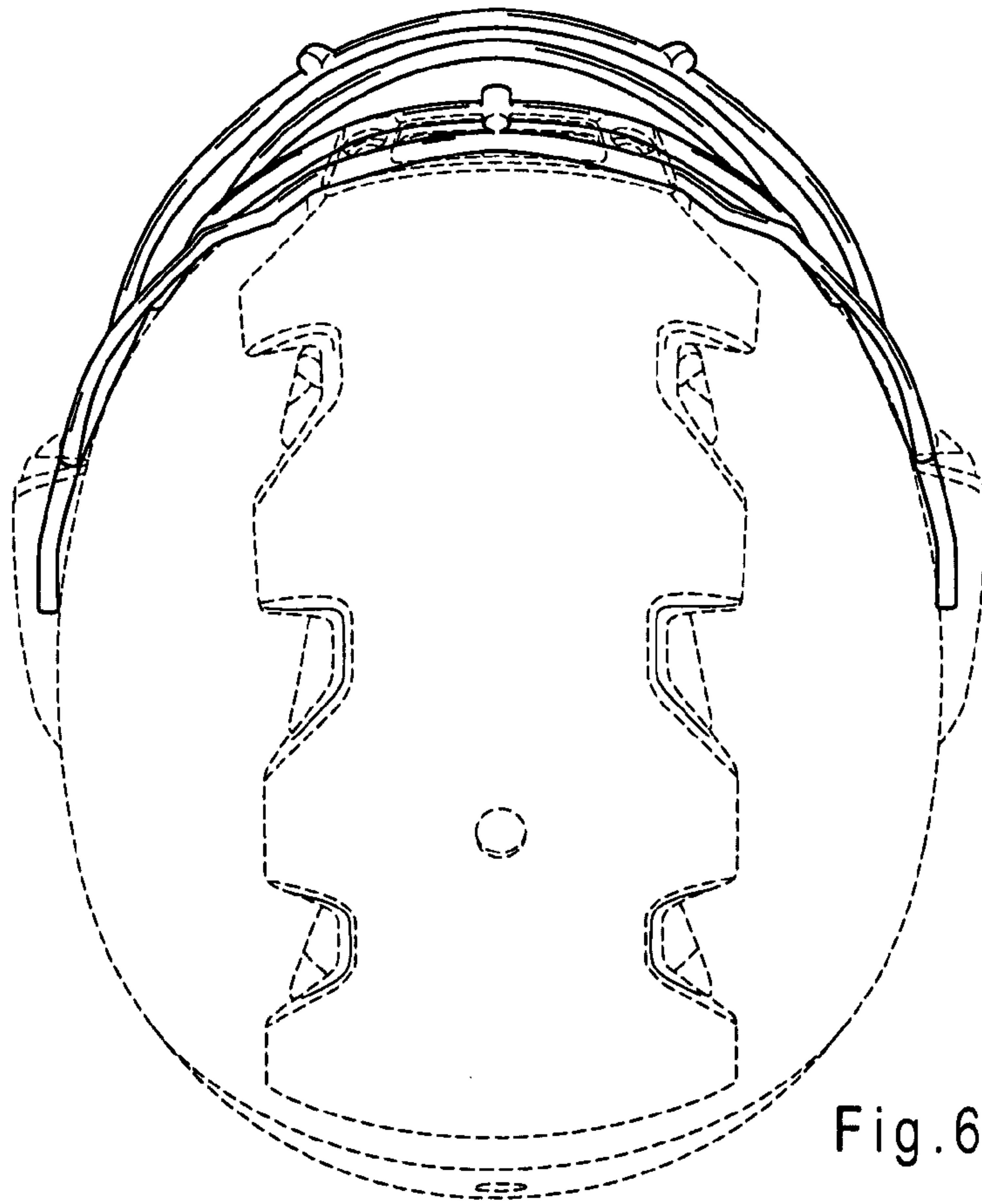

Fig. 6

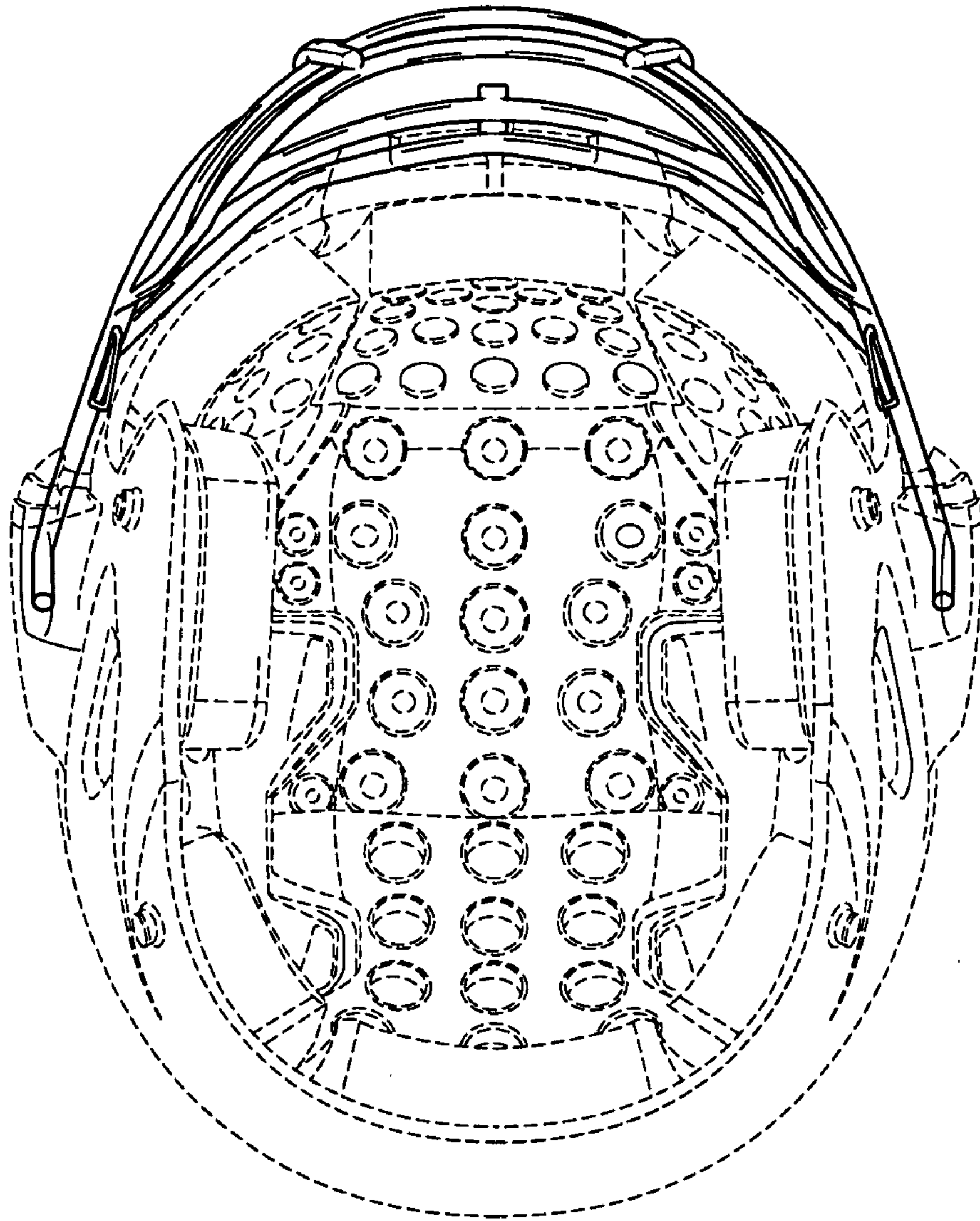

Fig. 7

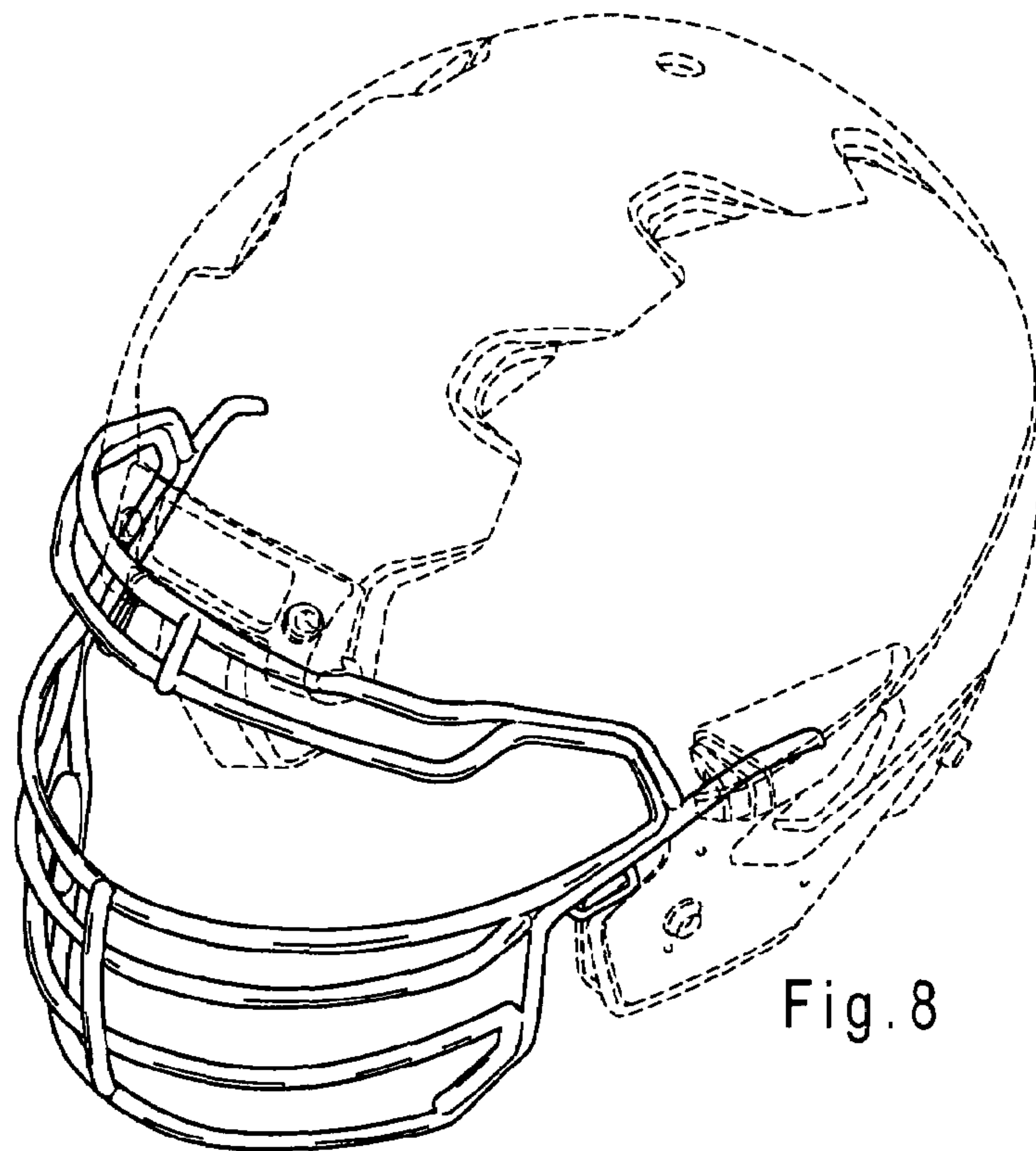

Fig. 8

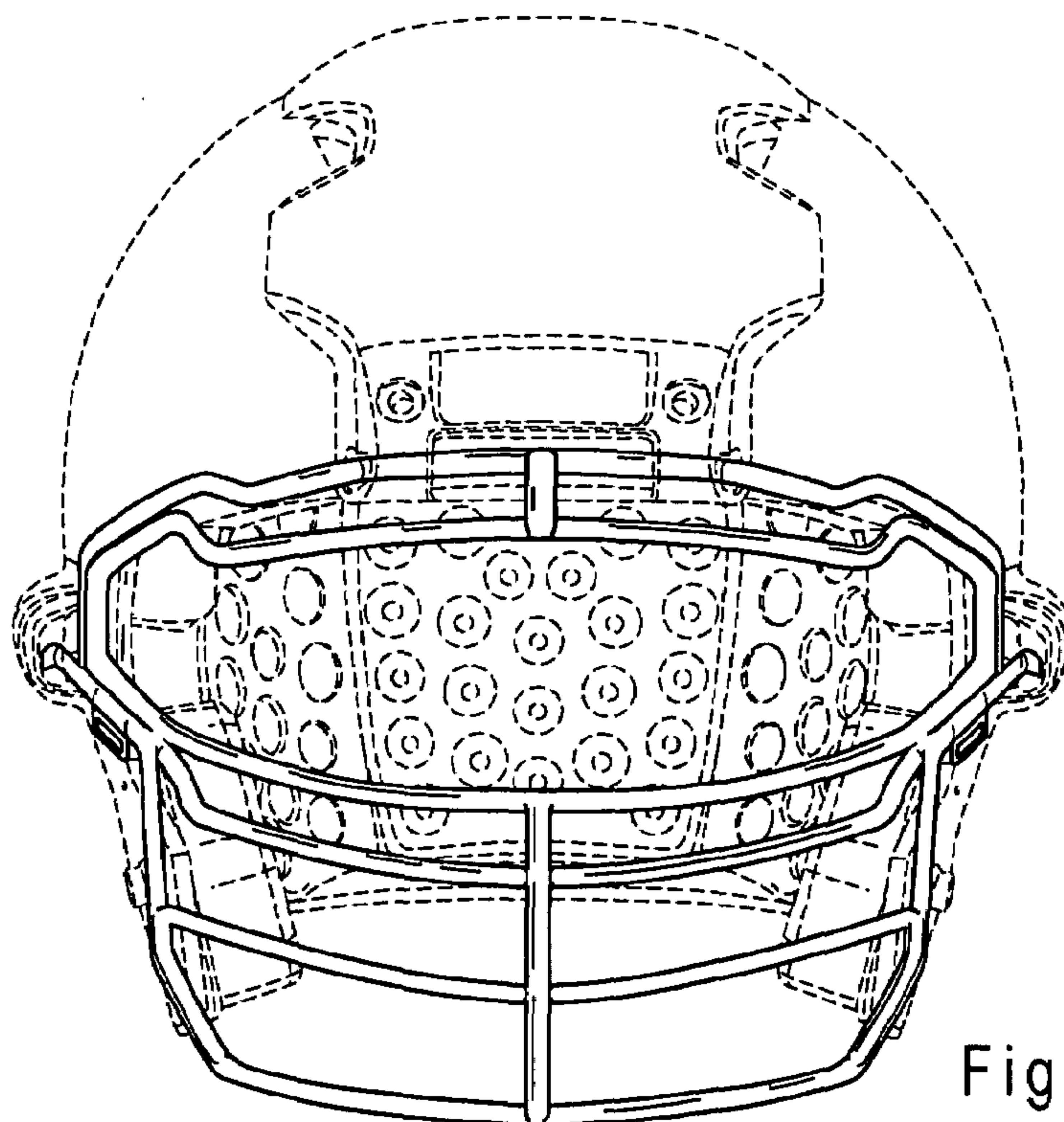

Fig. 9

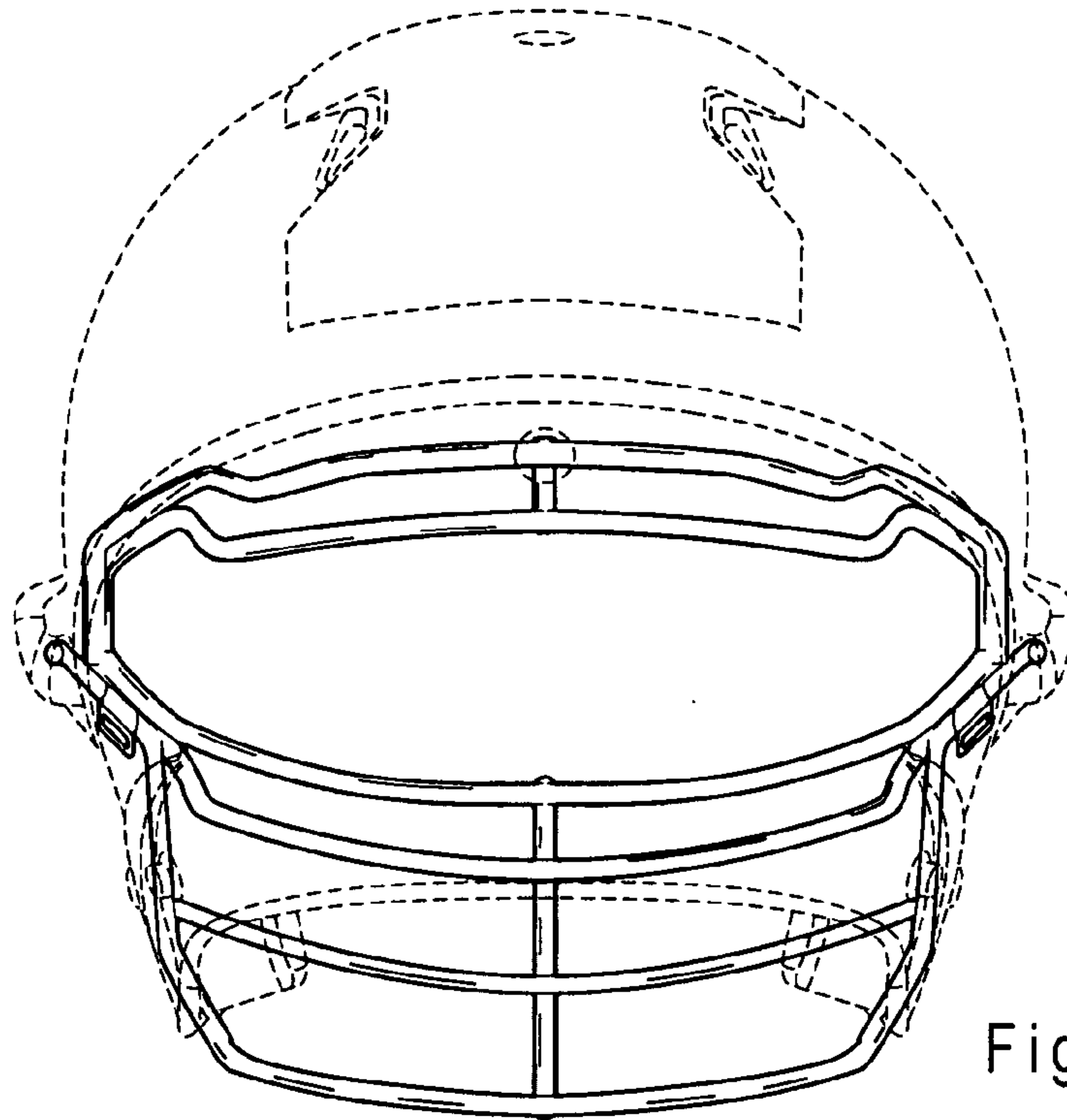

Fig. 10

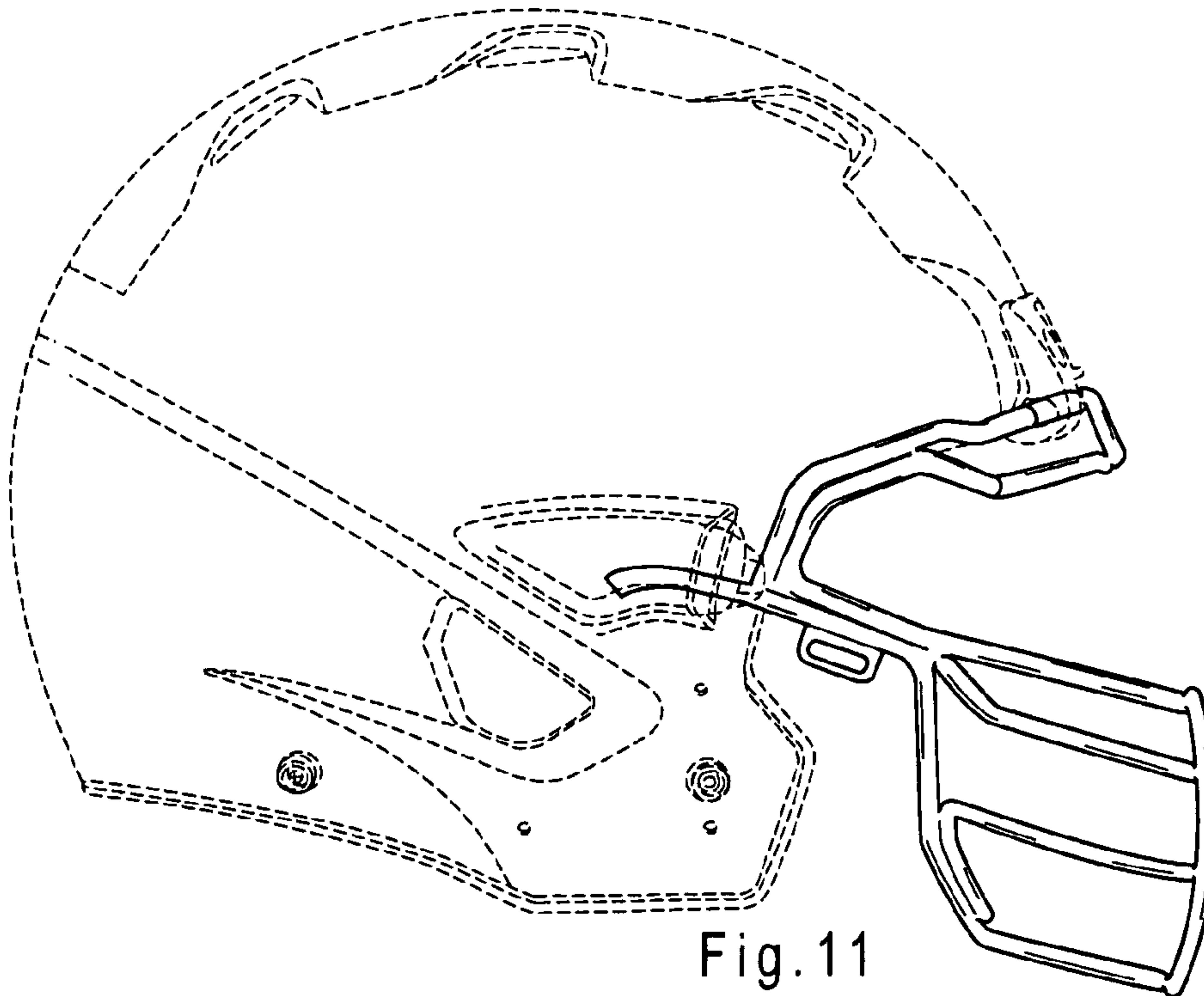

Fig. 11

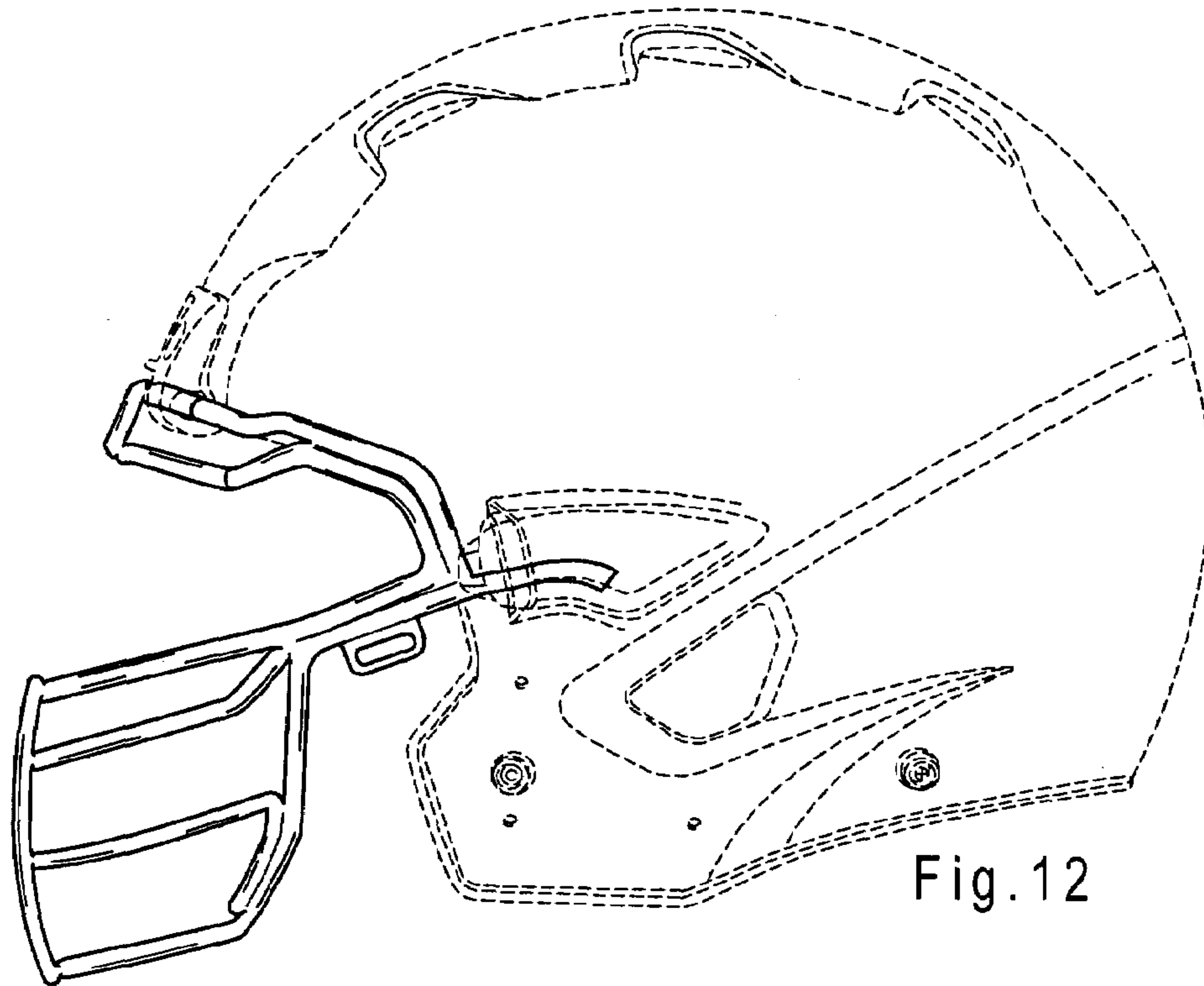

Fig. 12

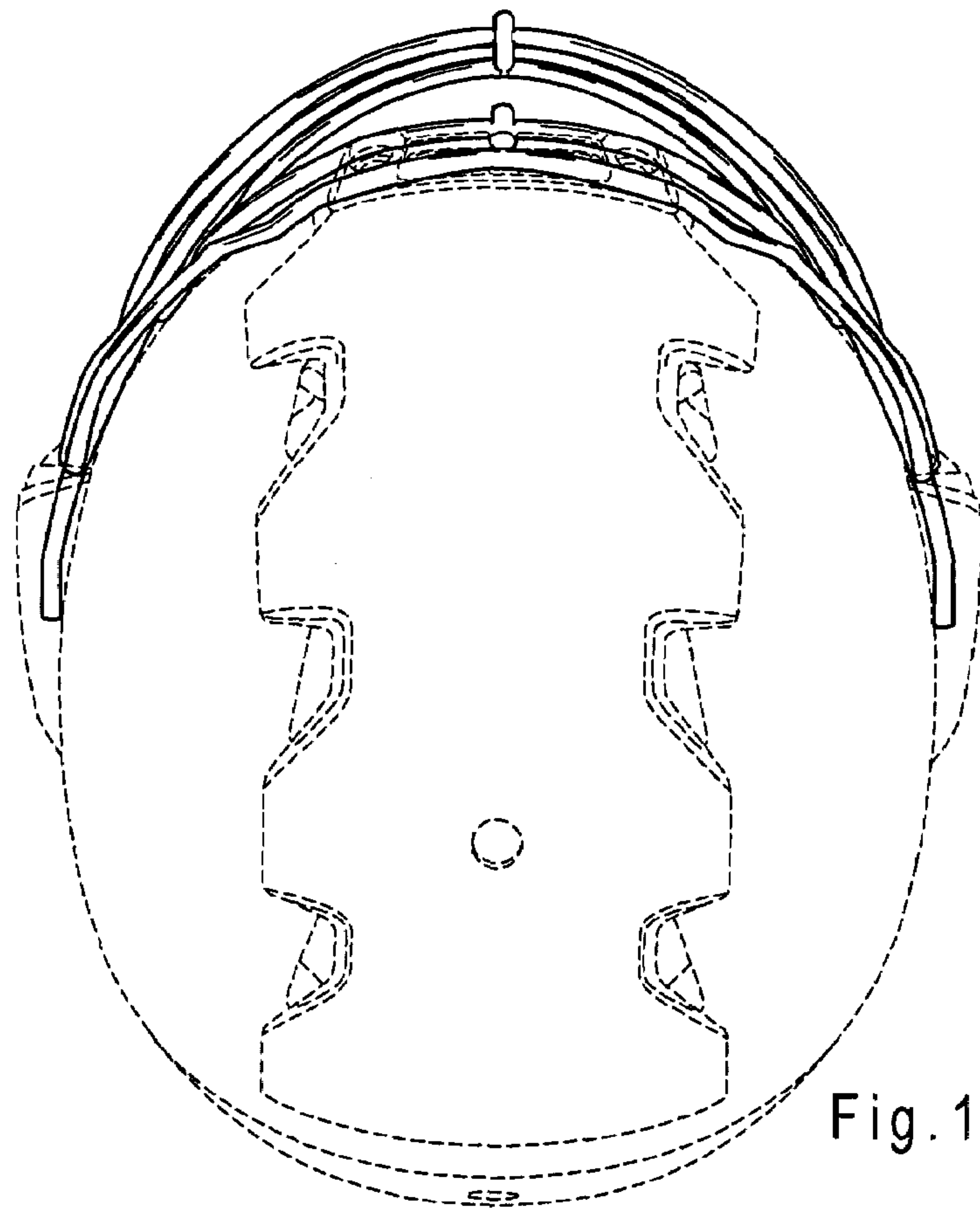

Fig. 13

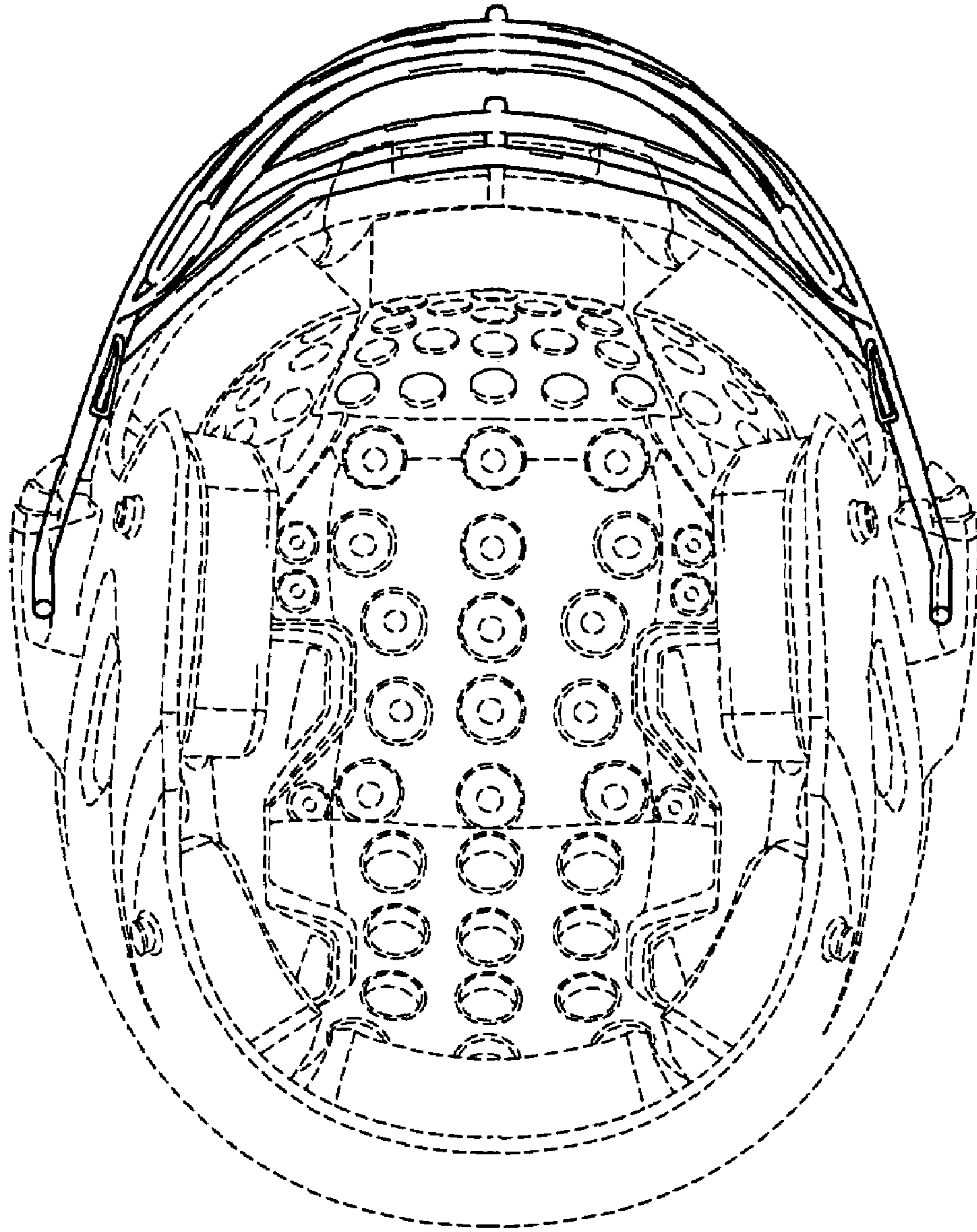

Fig. 14