



US00D590019S

(12) **United States Design Patent**
Urdarevik

(10) **Patent No.:** **US D590,019 S**
(45) **Date of Patent:** **** Apr. 7, 2009**

(54) **AID FOR TEACHING PROJECTION DRAWING**

(57) **CLAIM**

(76) Inventor: **Slobodan Urdarevik**, 1108 Imperial Crescent, Windsor Ontario (CA) N96 2T4

The ornamental design for aid for teaching projection drawing, as shown and described.

(**) Term: **14 Years**

DESCRIPTION

(21) Appl. No.: **29/306,531**

FIG. 1 is a front perspective view of the aid for teaching projection drawing showing my new design. Shown in condition of use with part patterns (on the aid for teaching projection drawing), pattern box and sample part. The technical drawing line indicia showing of a hidden line, center line, and hole center form part of the claimed design. The broken line showing of the sample part stand forms no part of the claimed design.

(22) Filed: **Apr. 10, 2008**

Related U.S. Application Data

(63) Continuation of application No. 29/238,260, filed on Sep. 14, 2005, now Pat. No. Des. 566,767.

FIG. 2 is a right side view thereof.

(51) **LOC (9) Cl.** **19-07**

FIG. 3 is a front view thereof.

(52) **U.S. Cl.** **D19/62**

FIG. 4 is a left side view thereof.

(58) **Field of Classification Search** D19/20, D19/59-64; D11/131, 157, 158; D21/483; 434/188, 195, 208, 211, 214, 283; D7/380; D24/176; D14/300

FIG. 5 is a rear view thereof.

FIG. 6 is a top view thereof.

FIG. 7 is a bottom view thereof.

See application file for complete search history.

FIG. 8 is a slightly enlarged detail front perspective view of a part inside the aid for teaching projection drawing. The broken line showing of the names of the colors on each face of the part forms no part of the claimed design.

(56) **References Cited**

U.S. PATENT DOCUMENTS

FIG. 9 is a right side view of the part thereof.

FIG. 10 is a front view of the part thereof.

FIG. 11 is a left side view of the part thereof.

FIG. 12 is a rear view the part thereof.

FIG. 13 is a top view of the part thereof.

FIG. 14 is a bottom view of the part thereof; and,

FIG. 15 is a slightly reduced unfolded top planar view of the pattern box with the technical drawing line indicia showing of hidden lines, center lines, and hole center lines forms part of the claimed design.

The broken lines shown in the figures are for the purpose of illustrating the environment related to the claimed design and forms no part of the claimed design as to those figures.

D254,793 S	4/1980	Morey	
D259,866 S	7/1981	Mortillaro	
D286,651 S	11/1986	Morey	
D292,932 S	11/1987	McGinley	
D297,437 S	8/1988	Mortensen	
D346,136 S	4/1994	Dollery	
D377,218 S	1/1997	Cohen	
D412,890 S	8/1999	Nesenoff	
D480,425 S	10/2003	Suchta	
D512,338 S	12/2005	Hannon	
D528,162 S	9/2006	Lucas	
D531,672 S	11/2006	Hannon	
D566,767 S *	4/2008	Urdarevik D19/62

* cited by examiner

Primary Examiner—Robert A. Delehanty

Assistant Examiner—Mark Cavanna

1 Claim, 15 Drawing Sheets

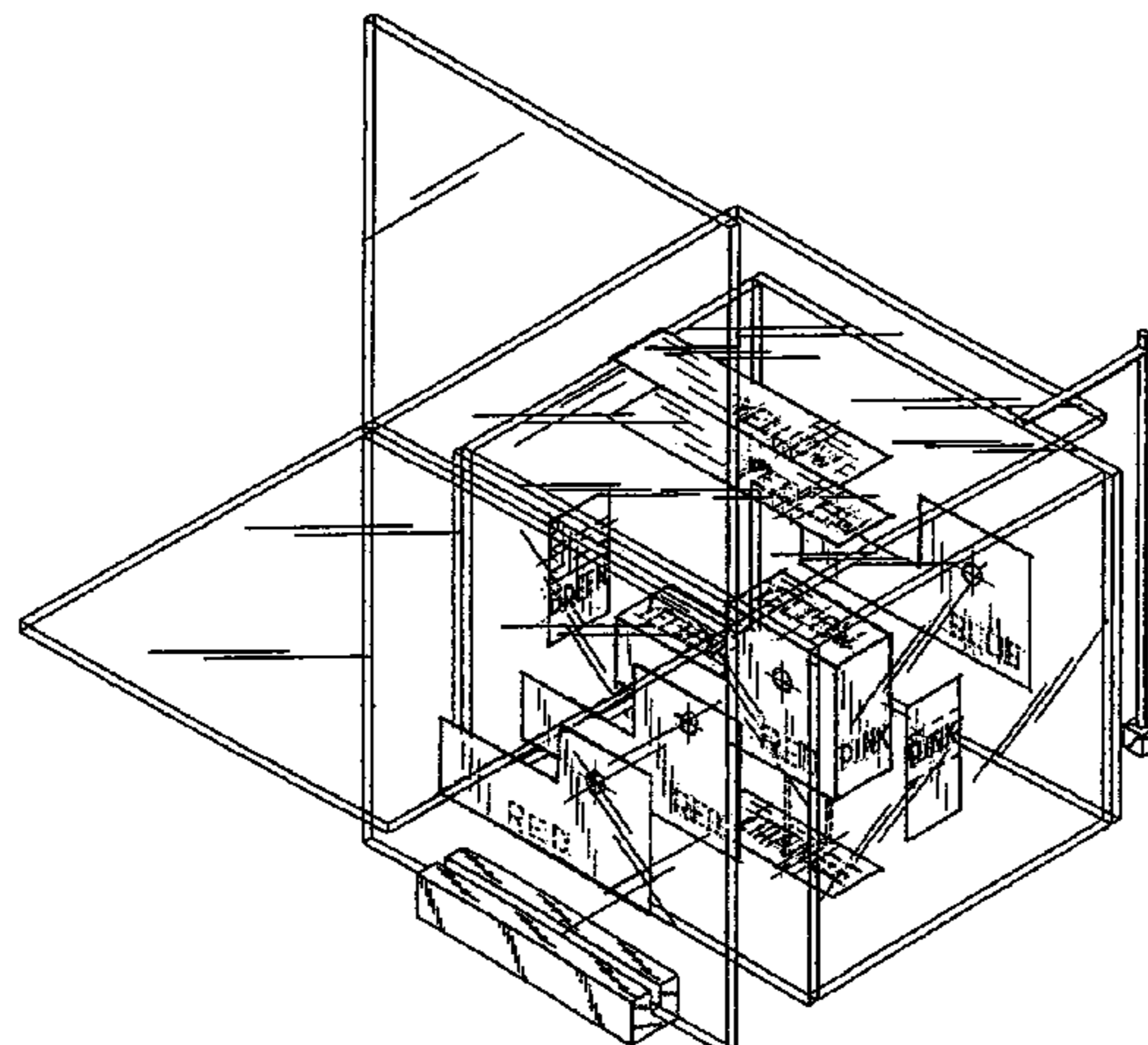

FIG. 1

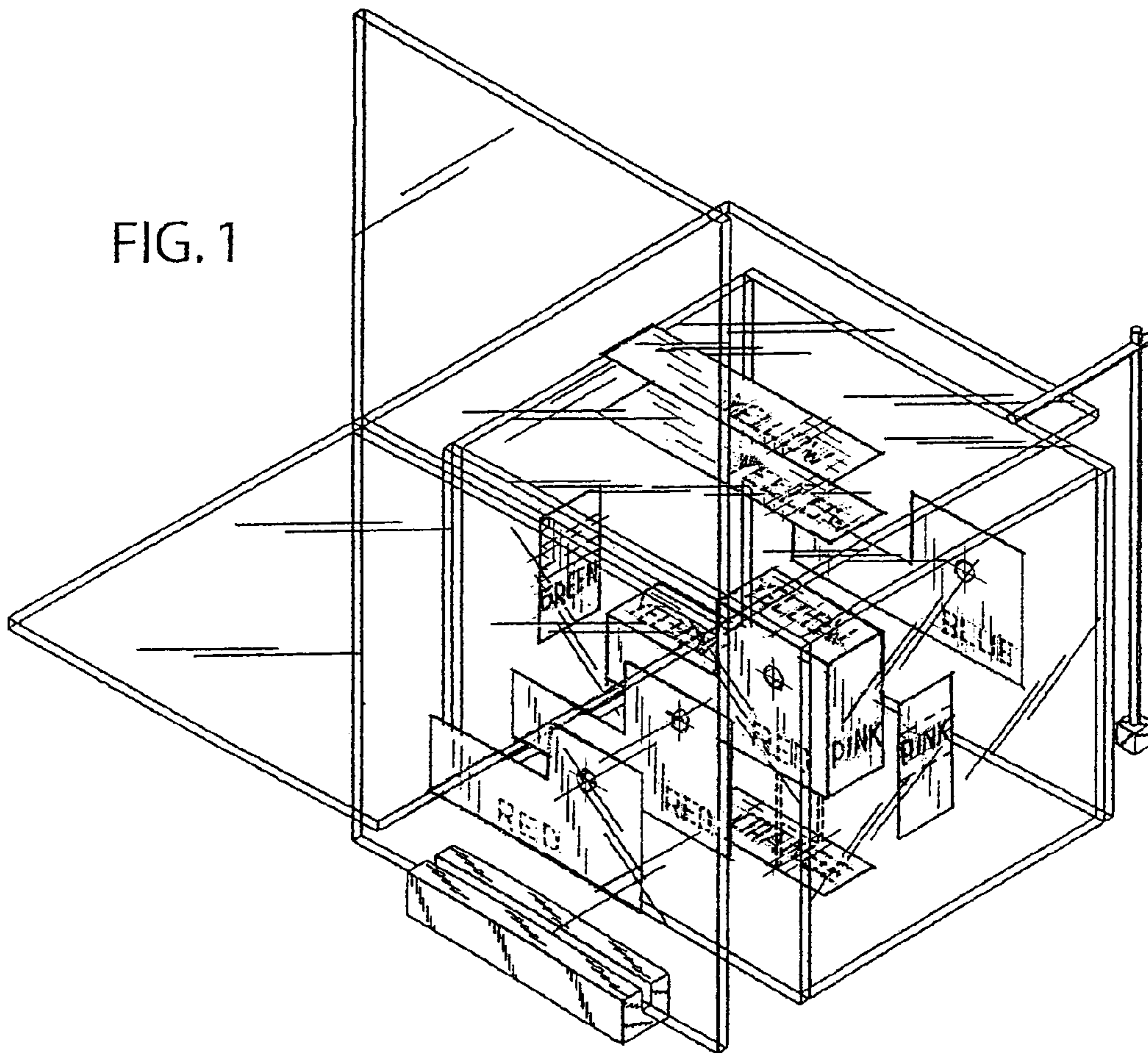

FIG. 2

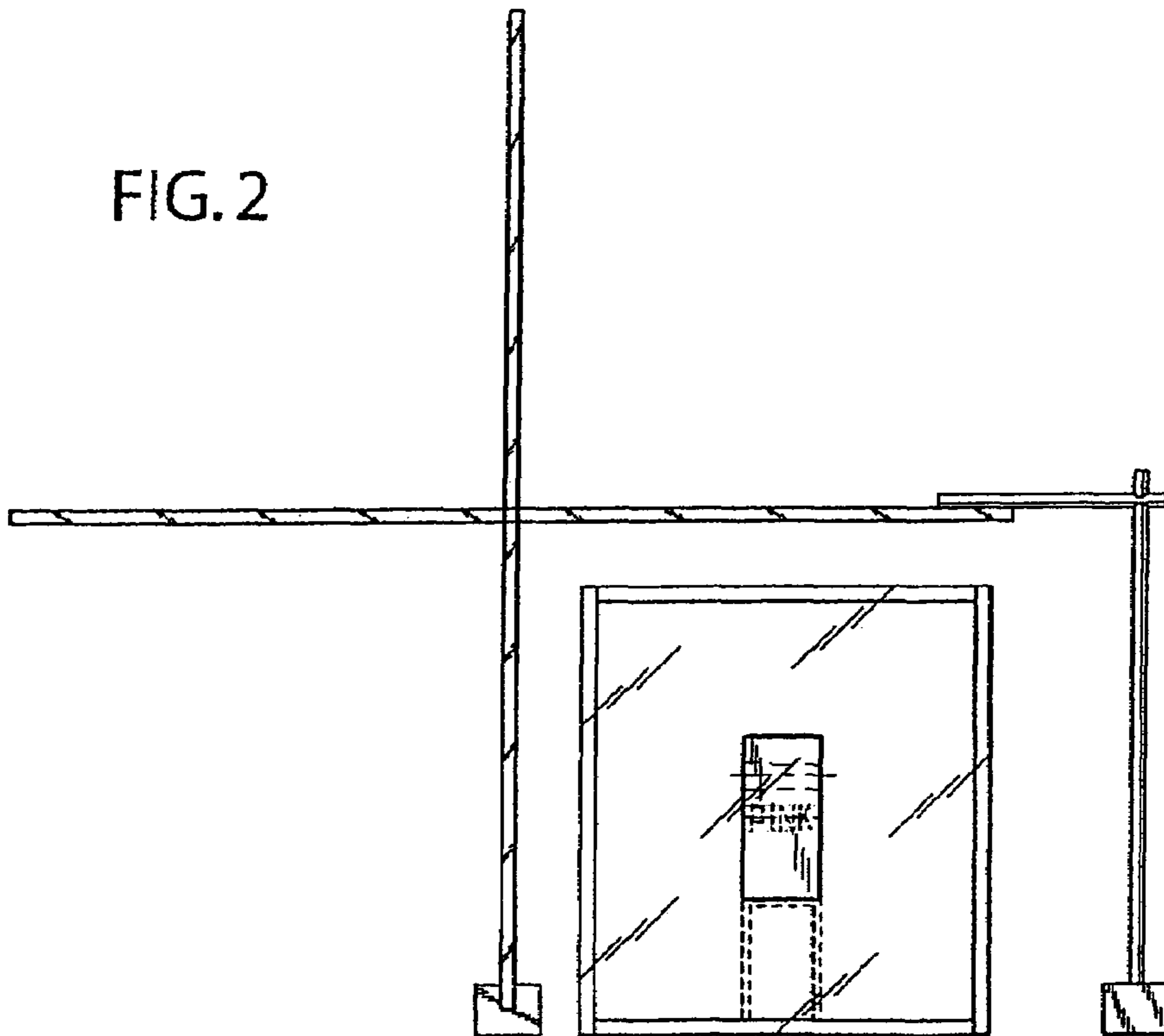

FIG. 3

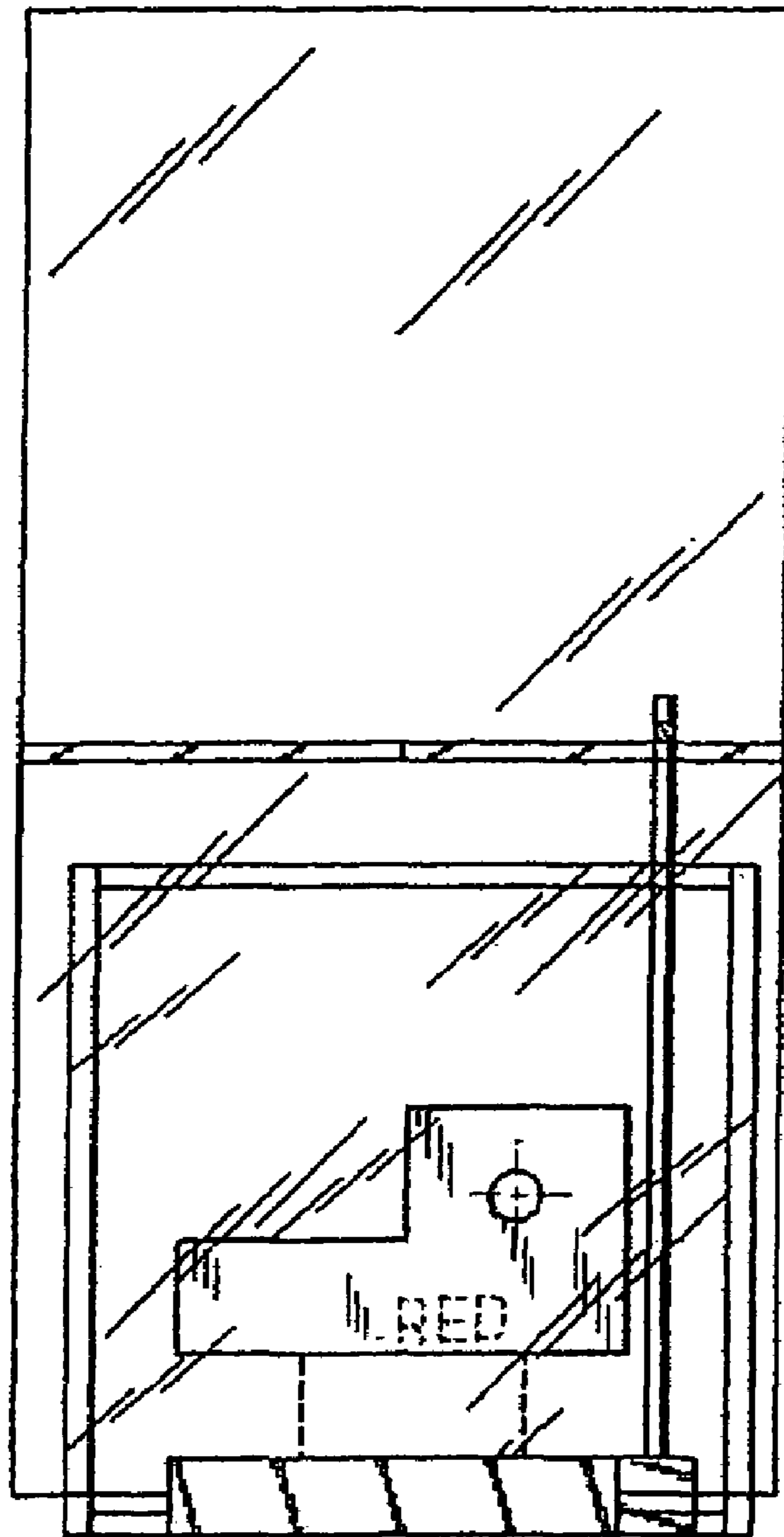

FIG. 4

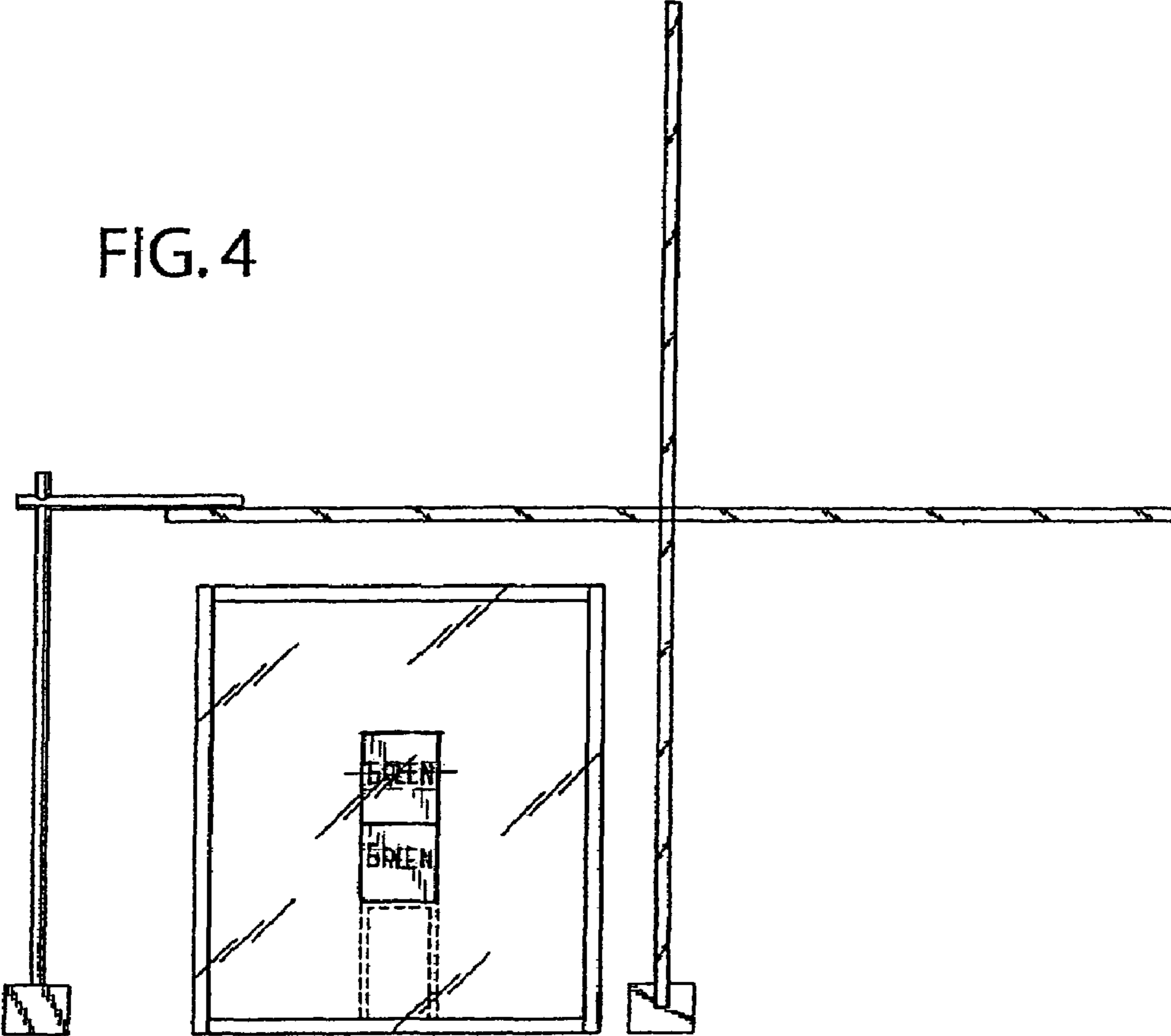

FIG. 5

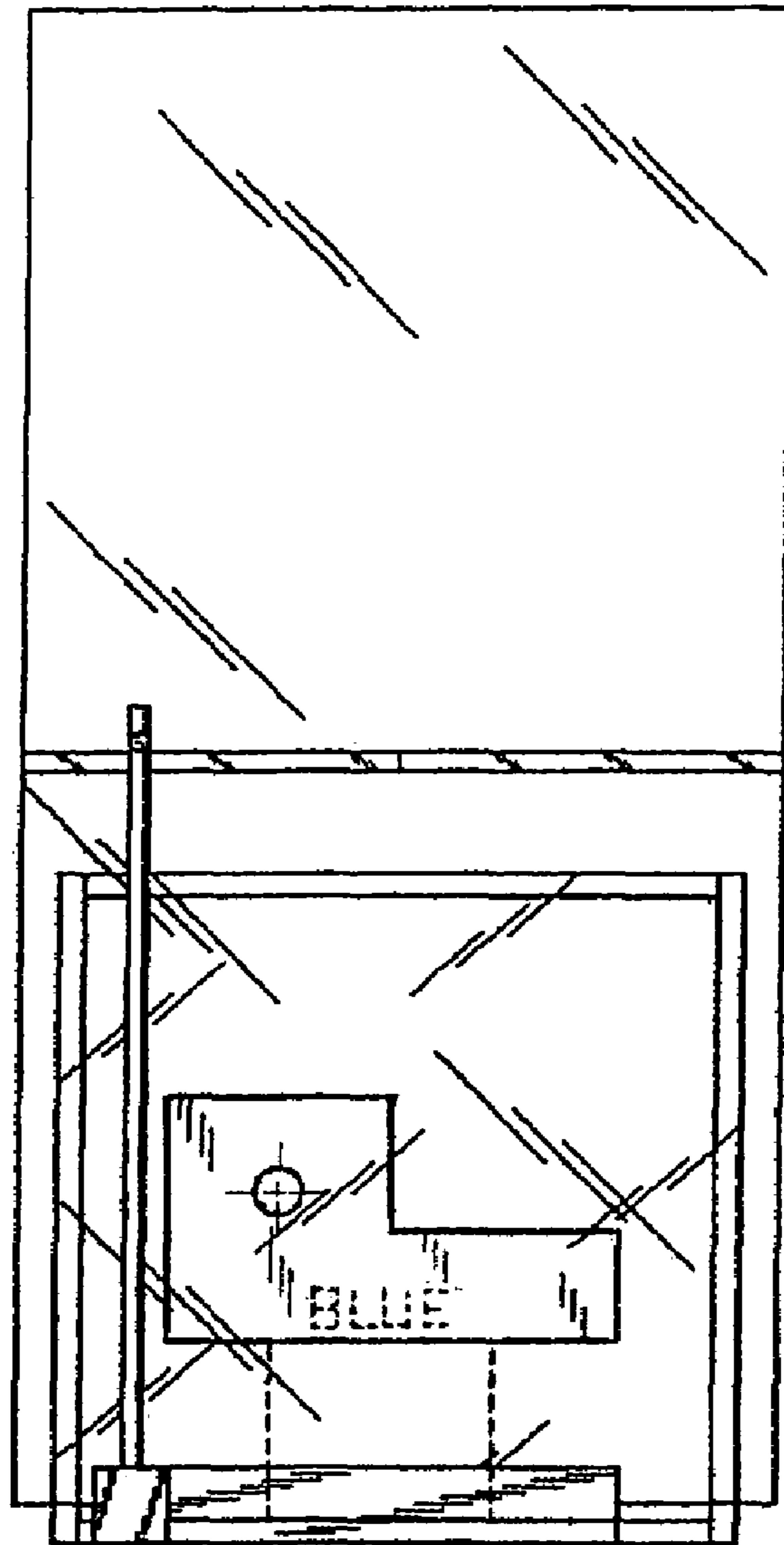
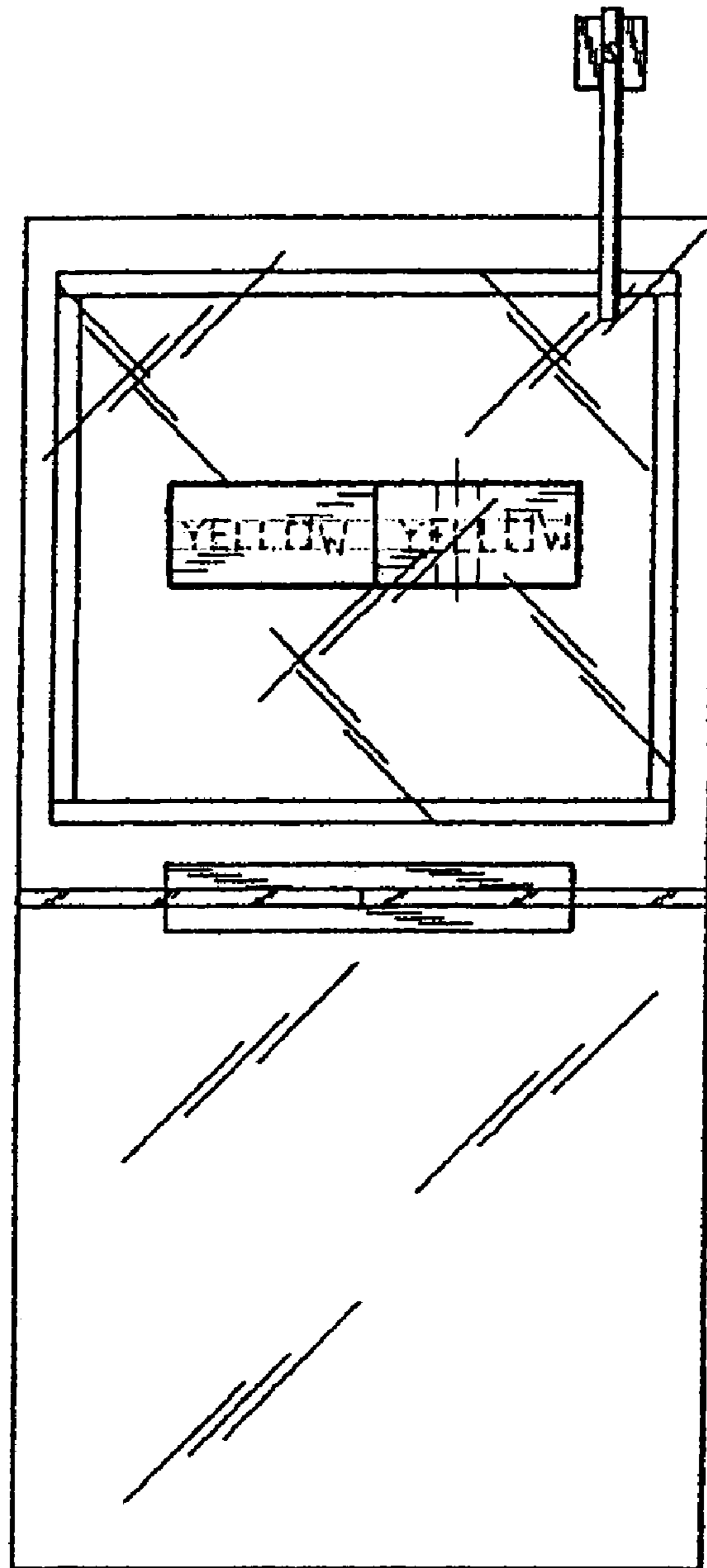

FIG. 6



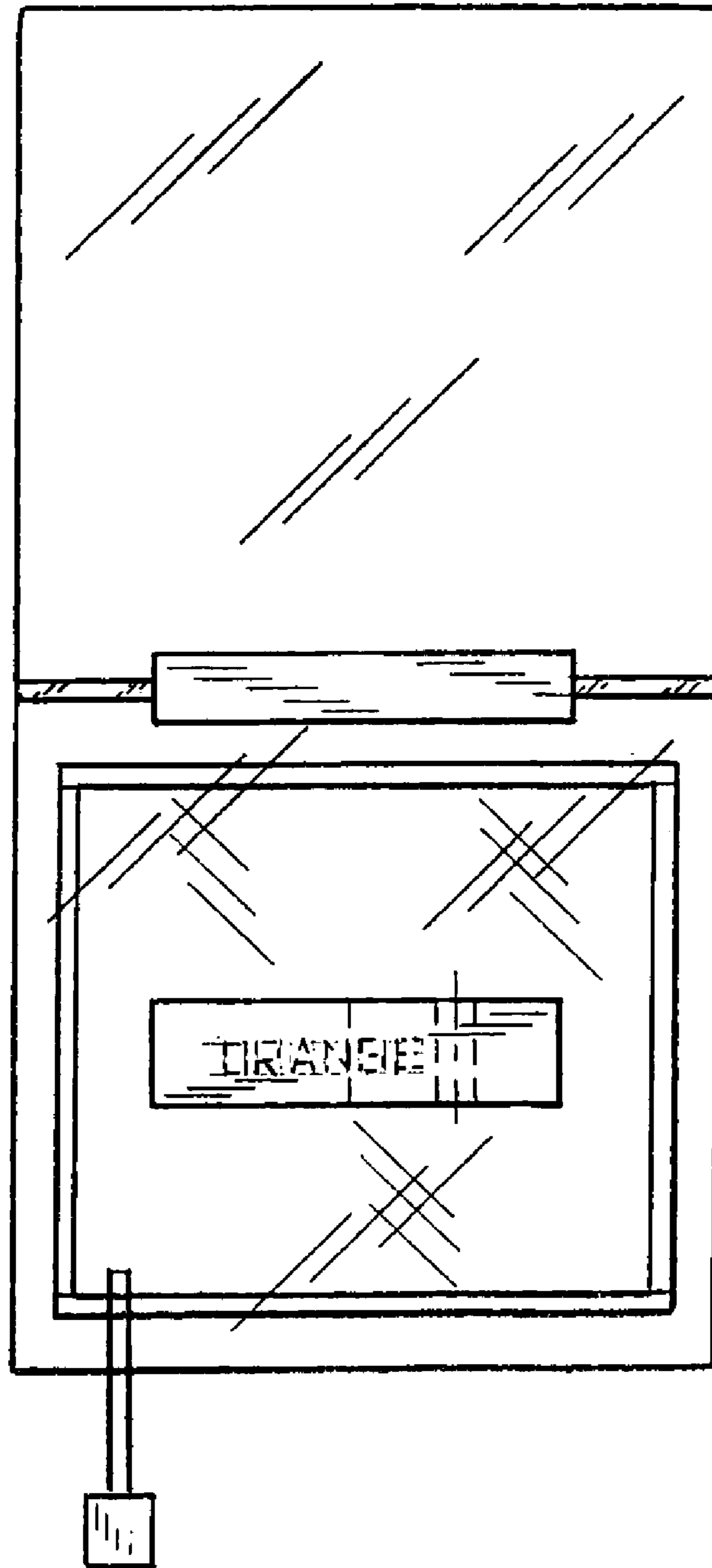

FIG. 7

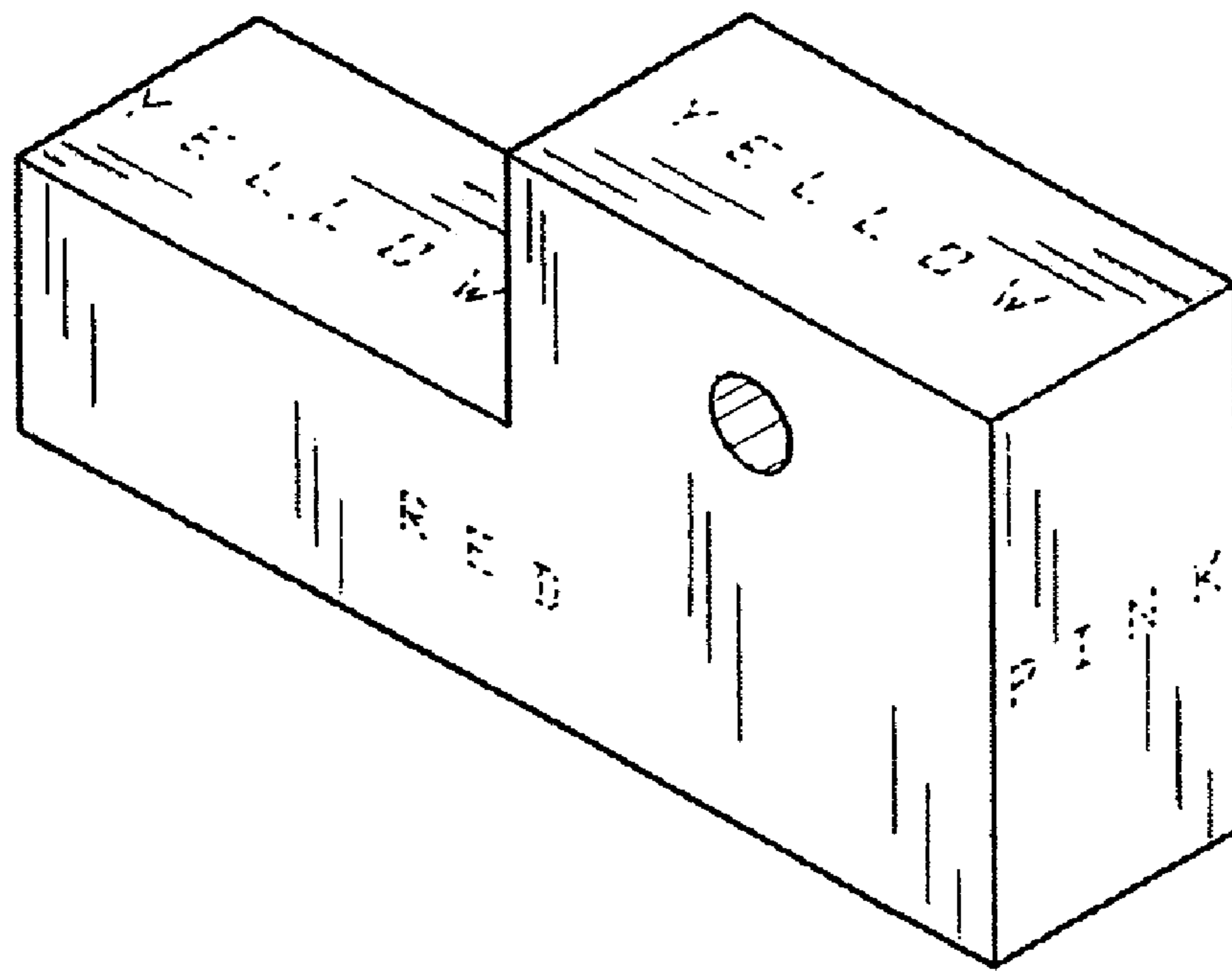

FIG. 8

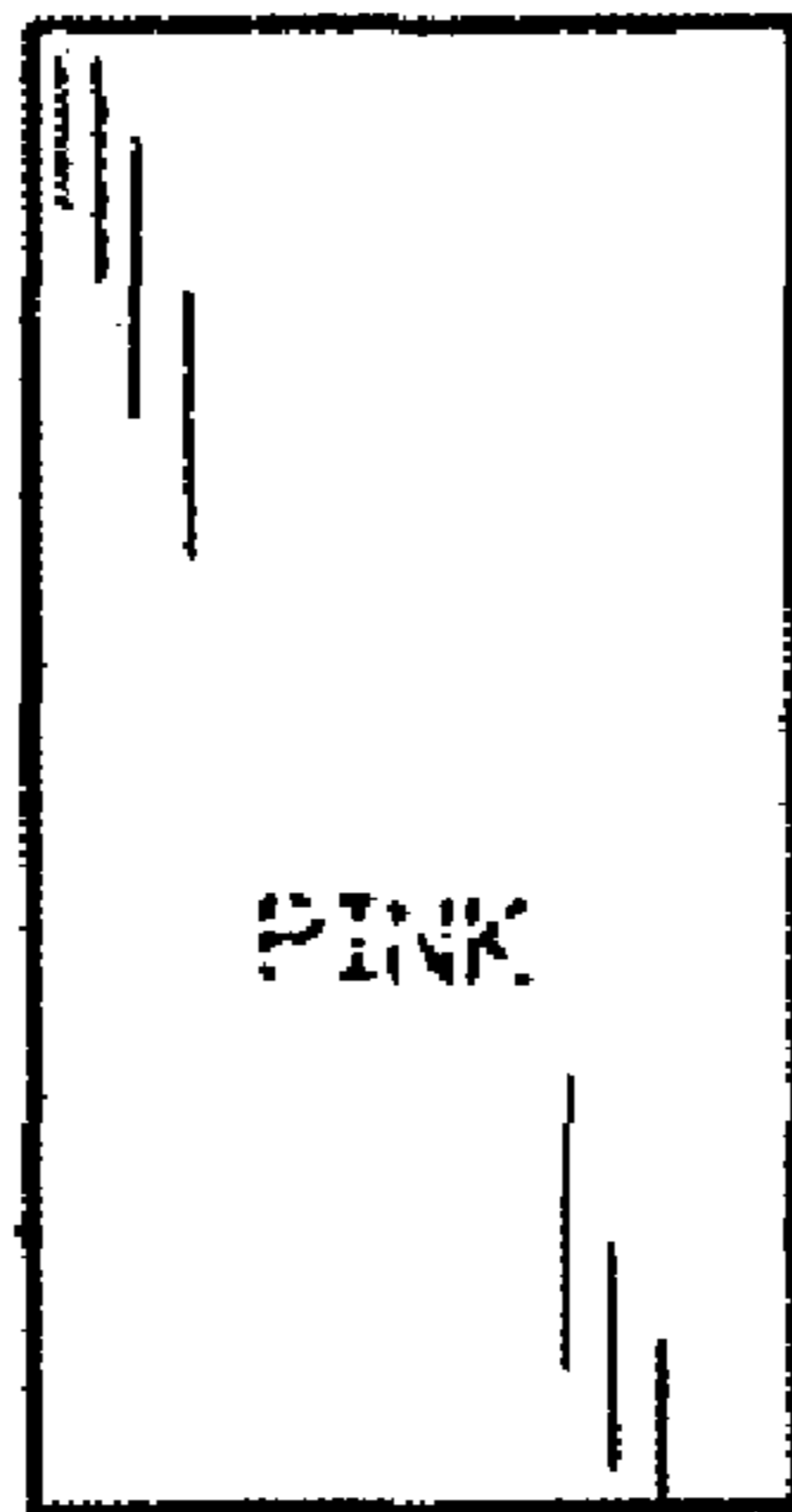

FIG. 9

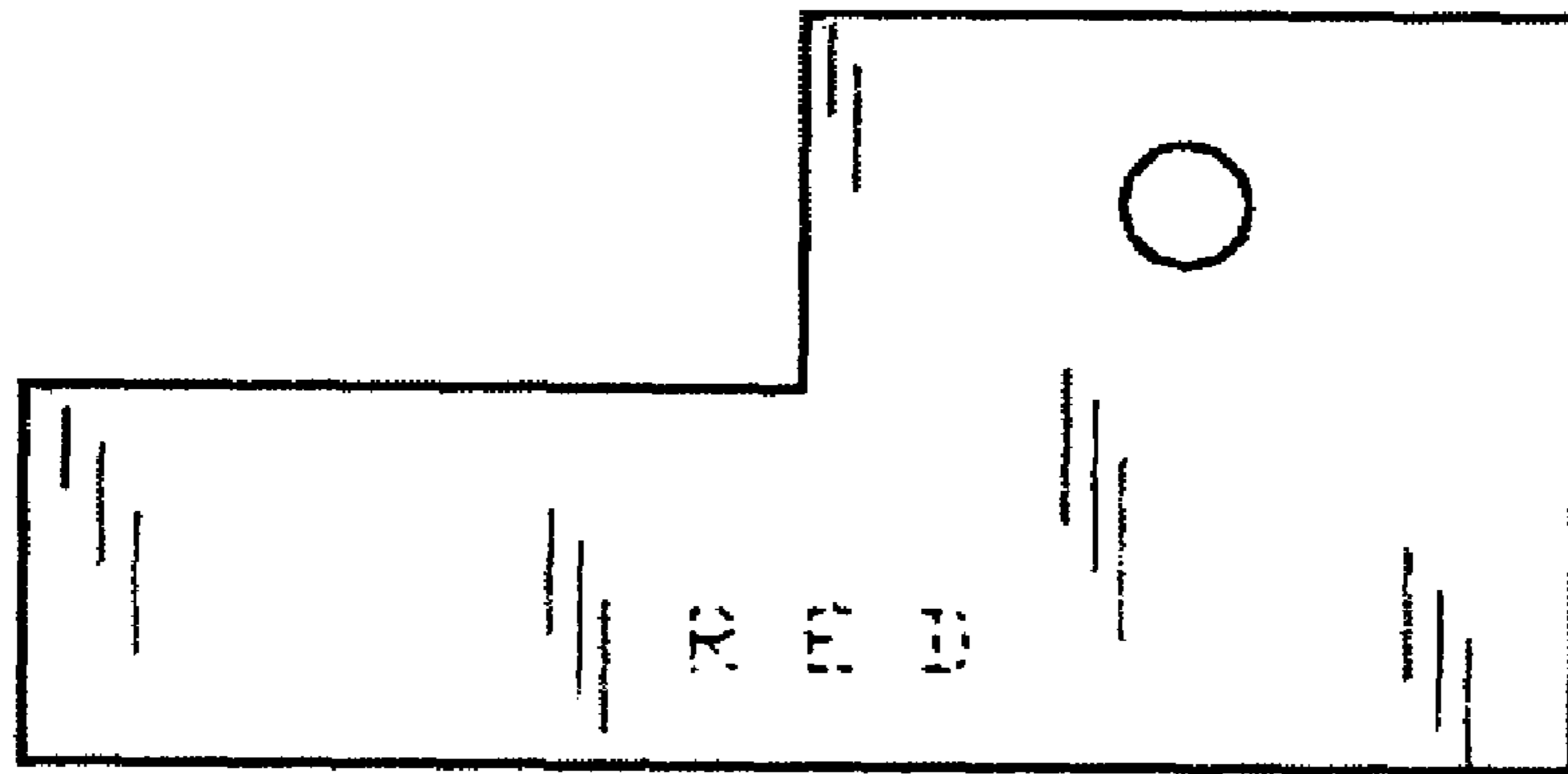

FIG. 10

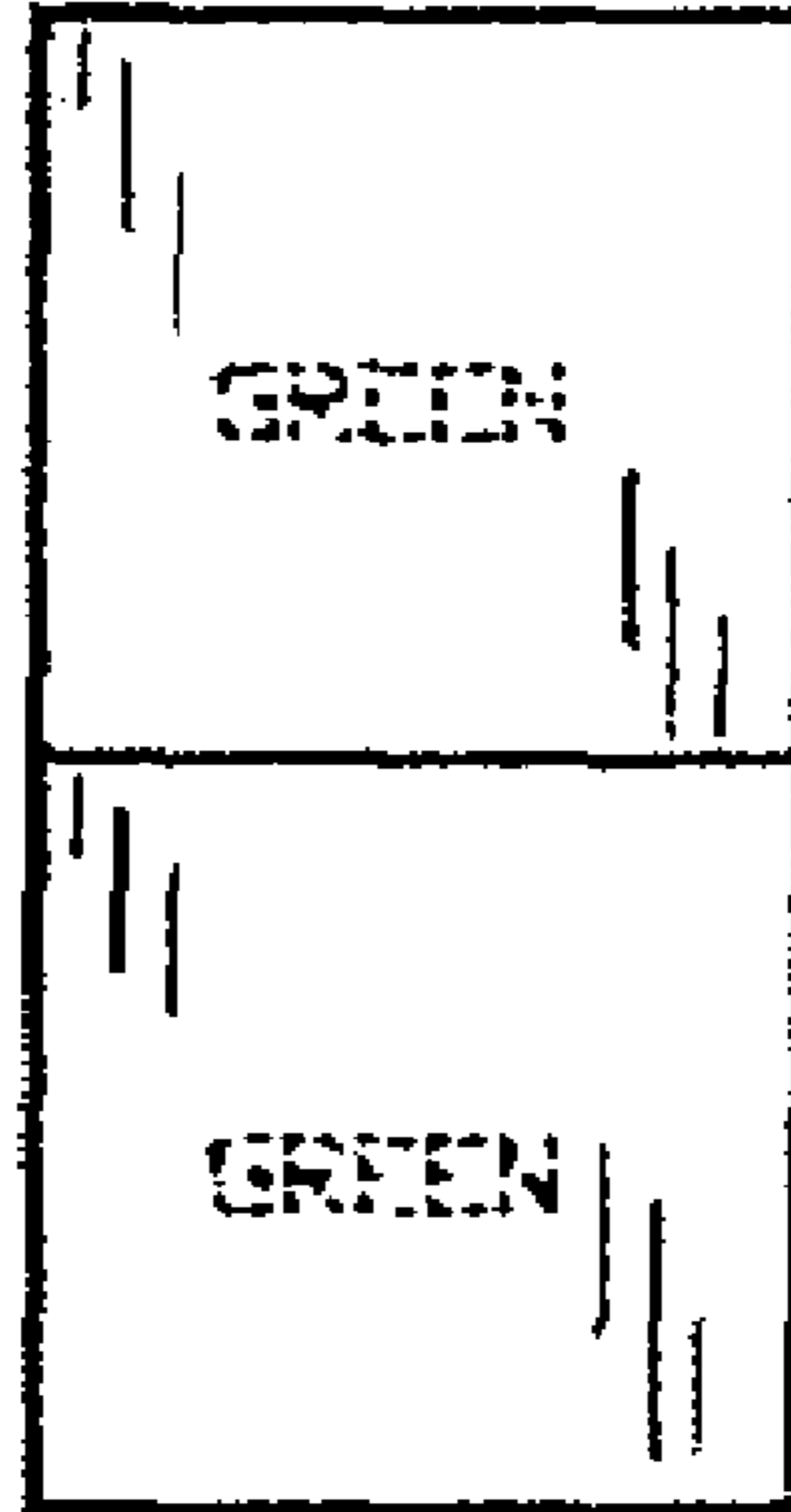

FIG. 11

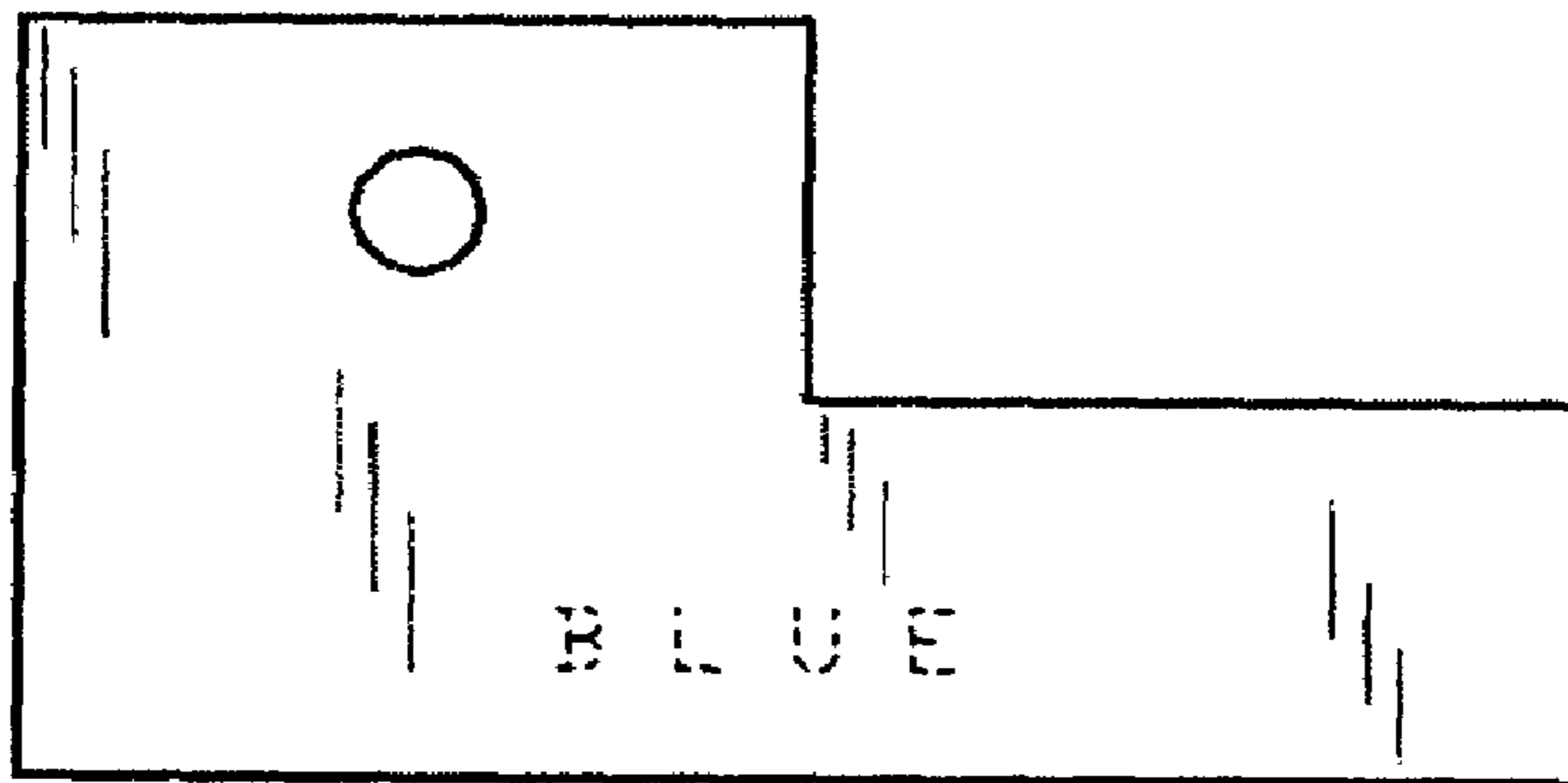

FIG. 12

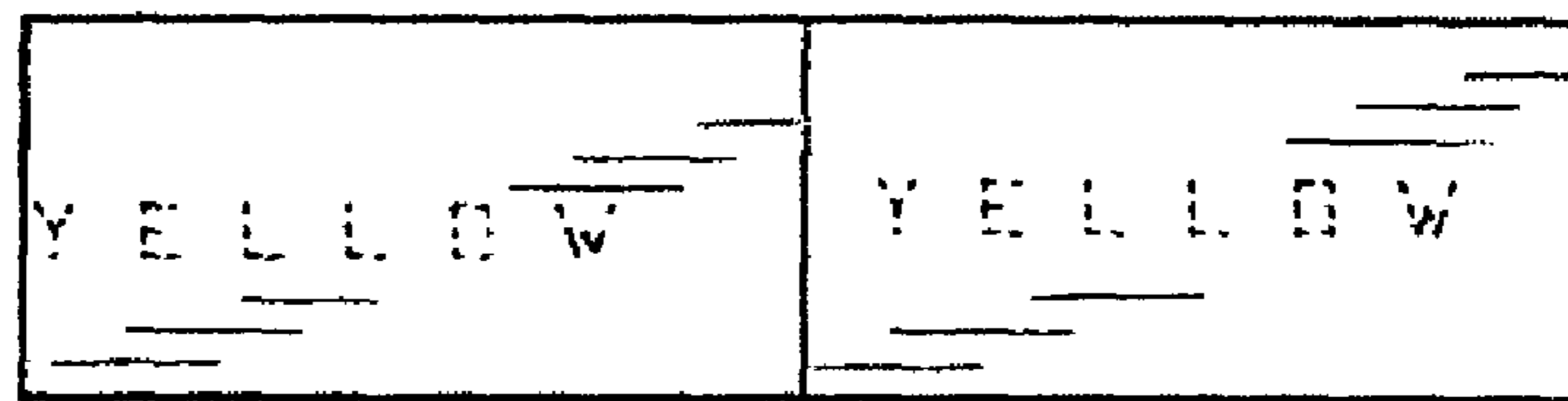

FIG. 13



FIG. 14

FIG. 15

