



US00D589981S

(12) **United States Design Patent**
Iekura

(10) **Patent No.:** **US D589,981 S**

(45) **Date of Patent:** **** Apr. 7, 2009**

(54) **UPPER PARTS UNIT FOR AN OUTBOARD MOTOR**

D531,639 S * 11/2006 Okamoto D15/4

* cited by examiner

(75) Inventor: **Shuji Iekura**, Kyoto-fu (JP)

Primary Examiner—Lisa P Lichtenstein

(74) *Attorney, Agent, or Firm*—Ostrolenk, Faber, Gerb & Soffen, LLP

(73) Assignee: **Yamaha Hatsudoki Kabushiki Kaisha**
(JP)

(57) **CLAIM**

(**) Term: **14 Years**

The ornamental design for a upper parts unit for an outboard motor, as shown and described.

(21) Appl. No.: **29/317,504**

DESCRIPTION

(22) Filed: **Apr. 30, 2008**

FIG. 1 is a right side, front perspective view of upper parts unit for an outboard motor showing my new design;

(30) **Foreign Application Priority Data**

FIG. 2 is a left side, rear perspective view thereof;

Nov. 30, 2007 (JP) 2007-032810

FIG. 3 is a right side view thereof;

(51) **LOC (9) Cl.** **15-01**

FIG. 4 is a left side view thereof;

(52) **U.S. Cl.** **D15/4**

FIG. 5 is a front view thereof;

(58) **Field of Classification Search** D15/1-5;
55/337; 123/41.67, 198 E; 418/91; 60/299,
60/274, 324; 23/288 F

FIG. 6 is a rear view thereof;

See application file for complete search history.

FIG. 7 is a top plan view thereof; and,

FIG. 8 is a bottom view thereof.

(56) **References Cited**

The broken line showing of a portion of an upper parts unit for an outboard motor is included for the purpose of illustrating environmental structure and forms no part of the claimed design.

U.S. PATENT DOCUMENTS

D474,480 S * 5/2003 Zebley et al. D15/4

D495,716 S * 9/2004 Sanschagrin et al. D15/4

1 Claim, 4 Drawing Sheets

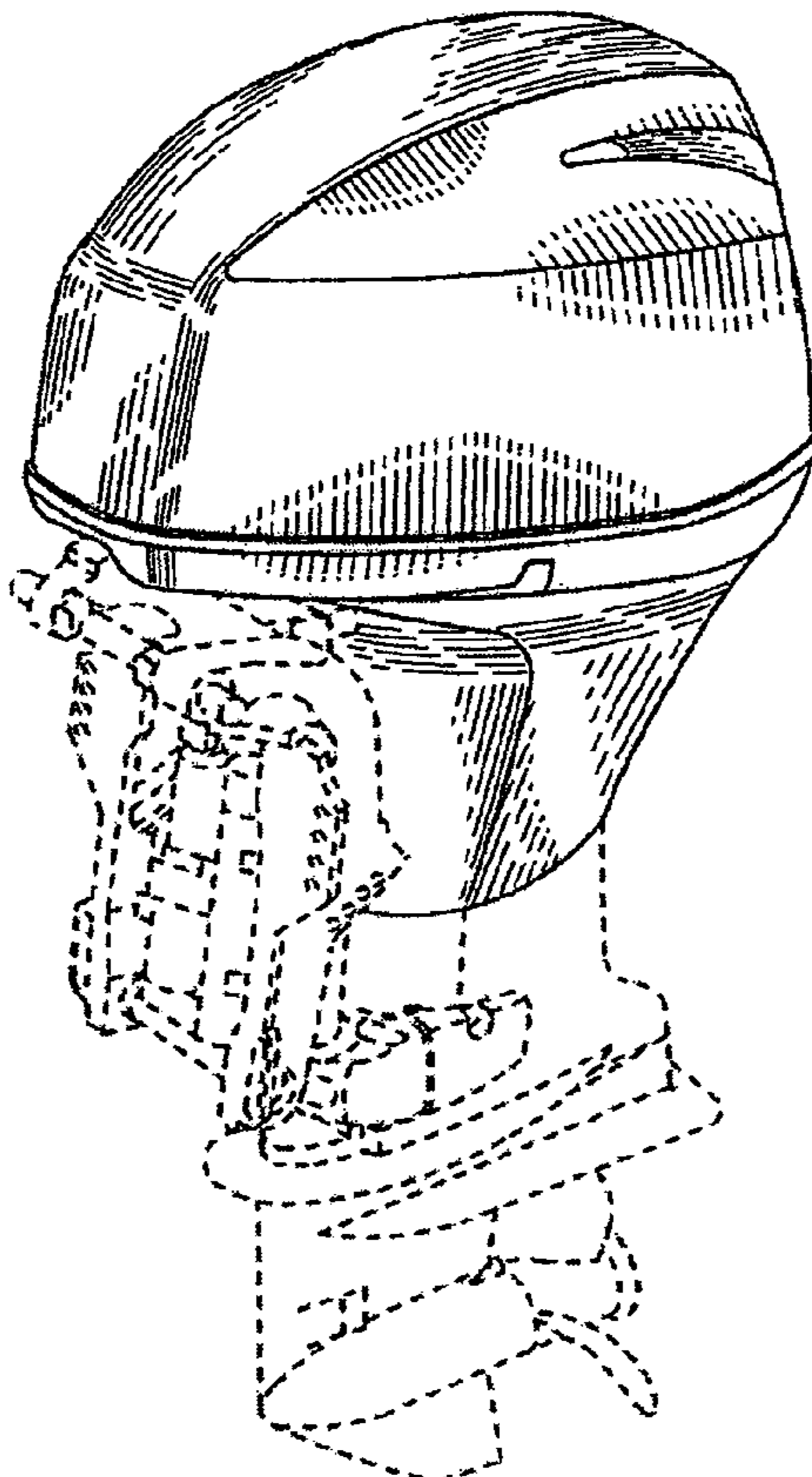

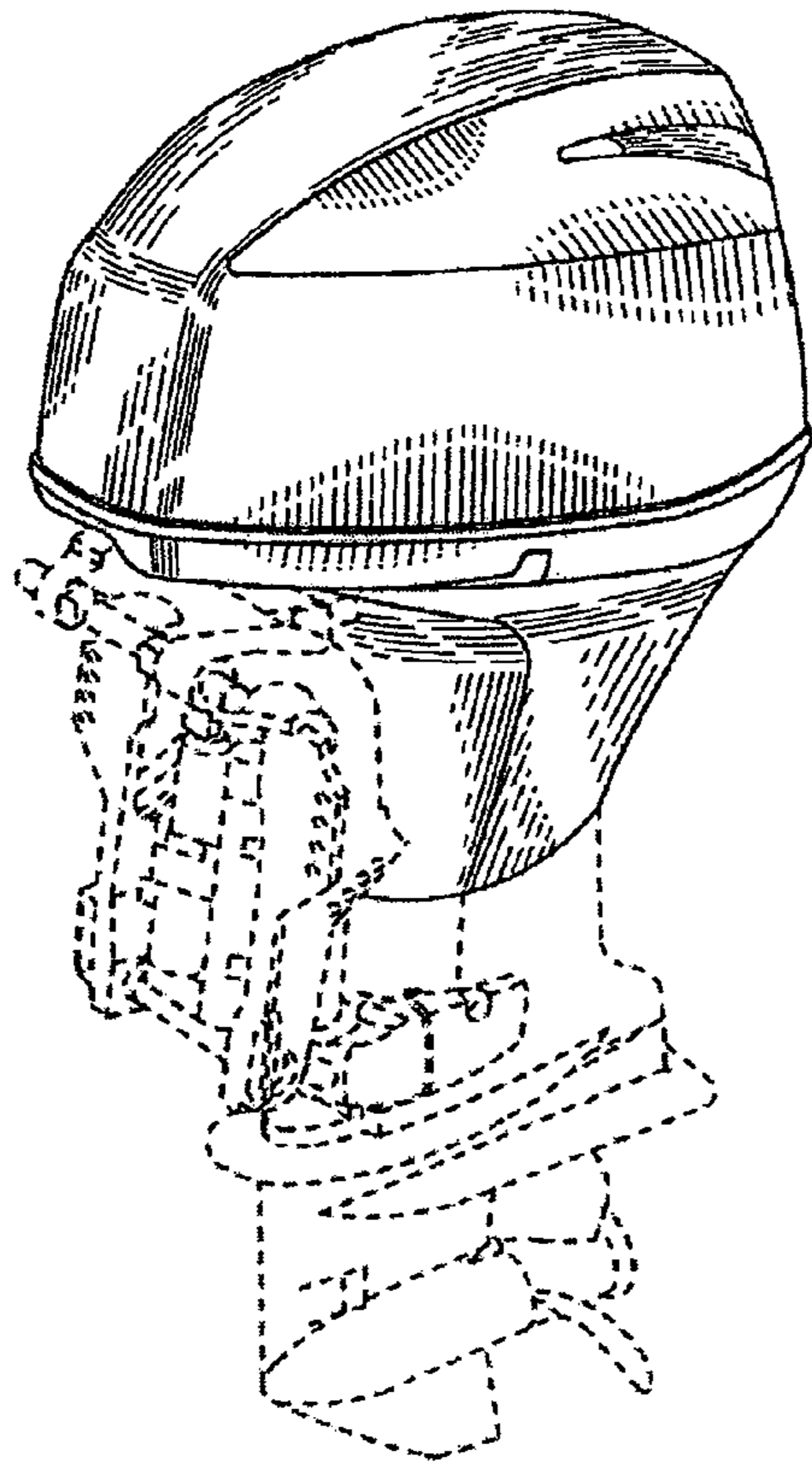

FIG. 1

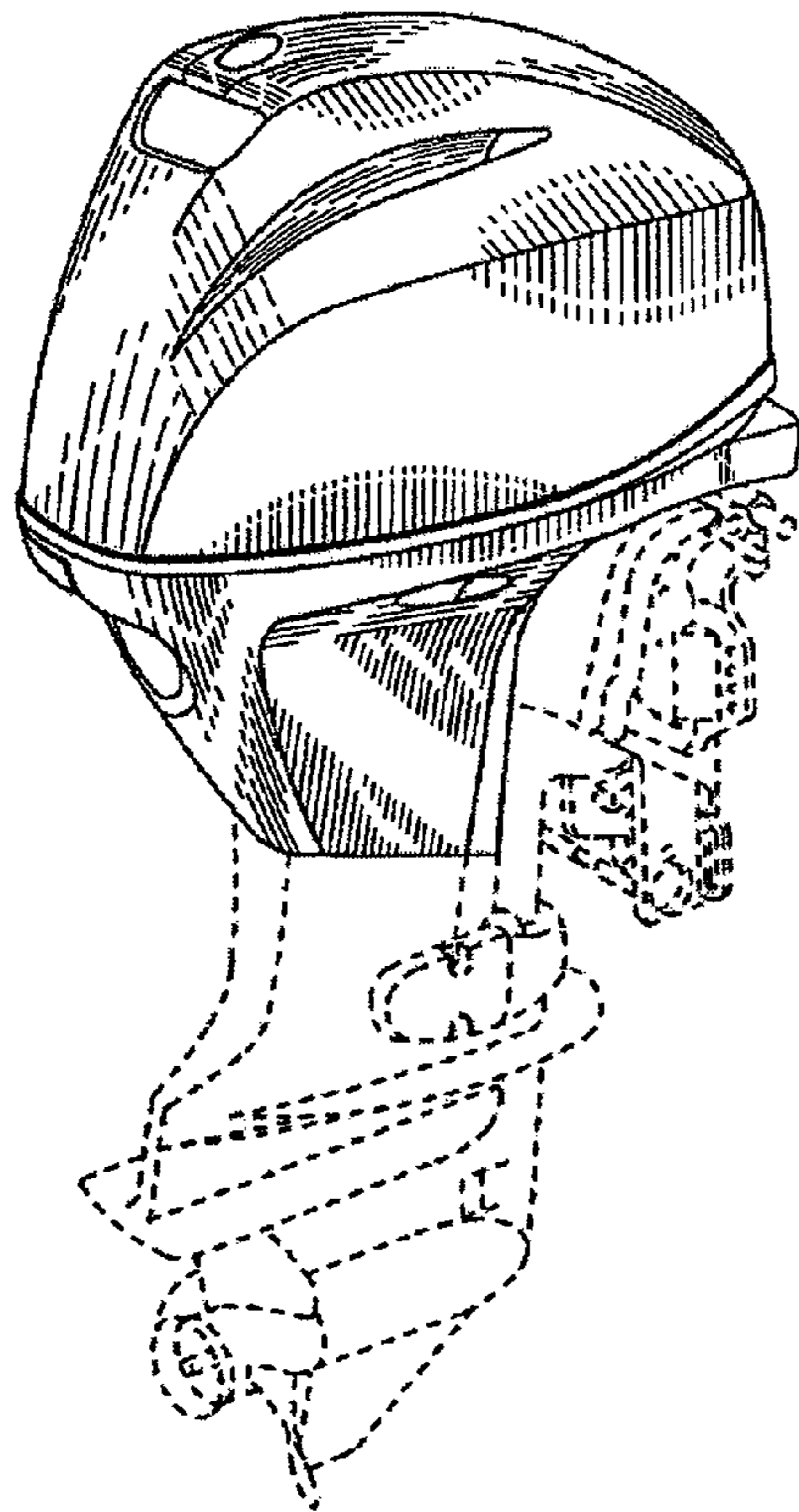

FIG. 2

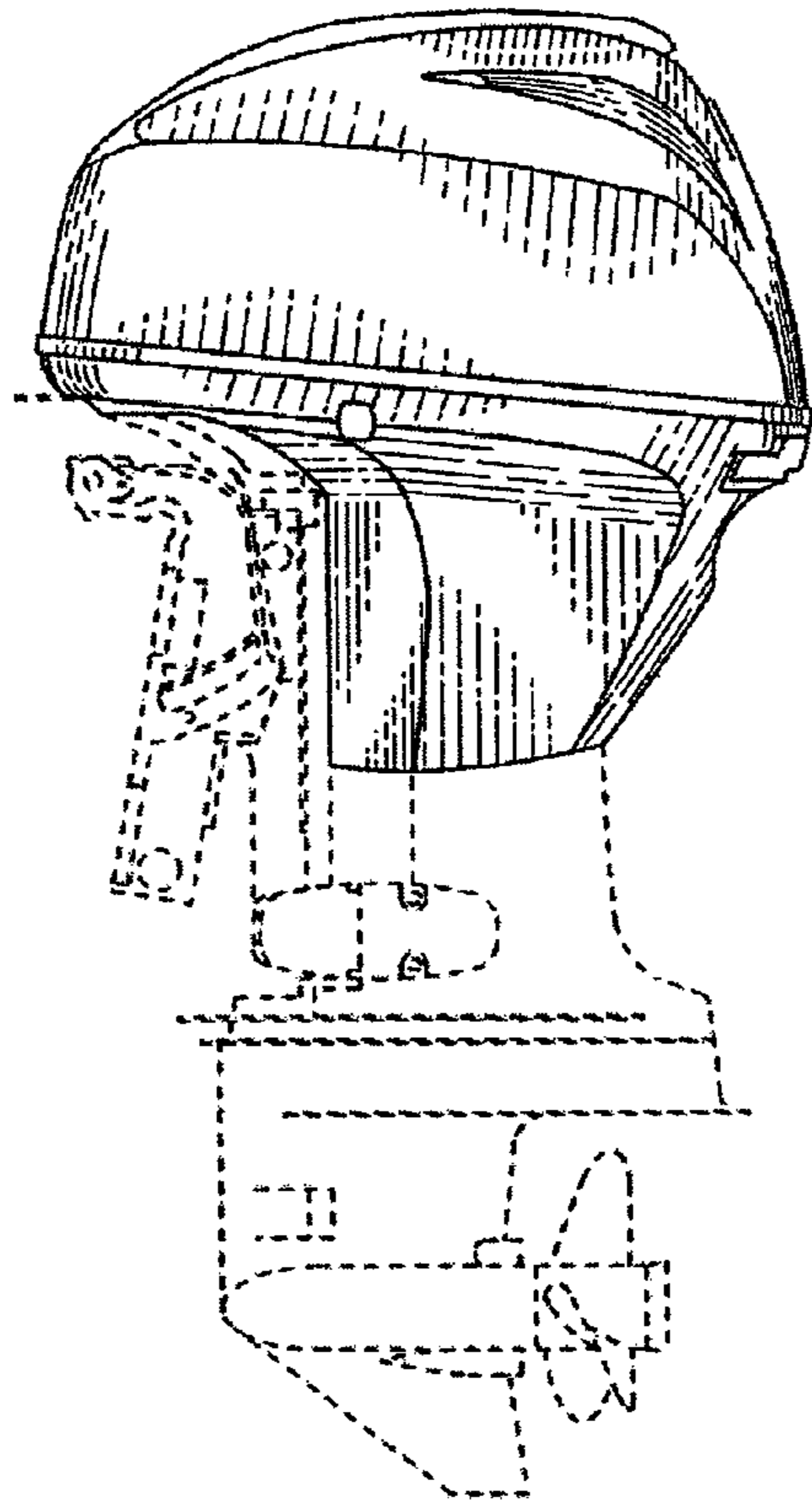

FIG. 3

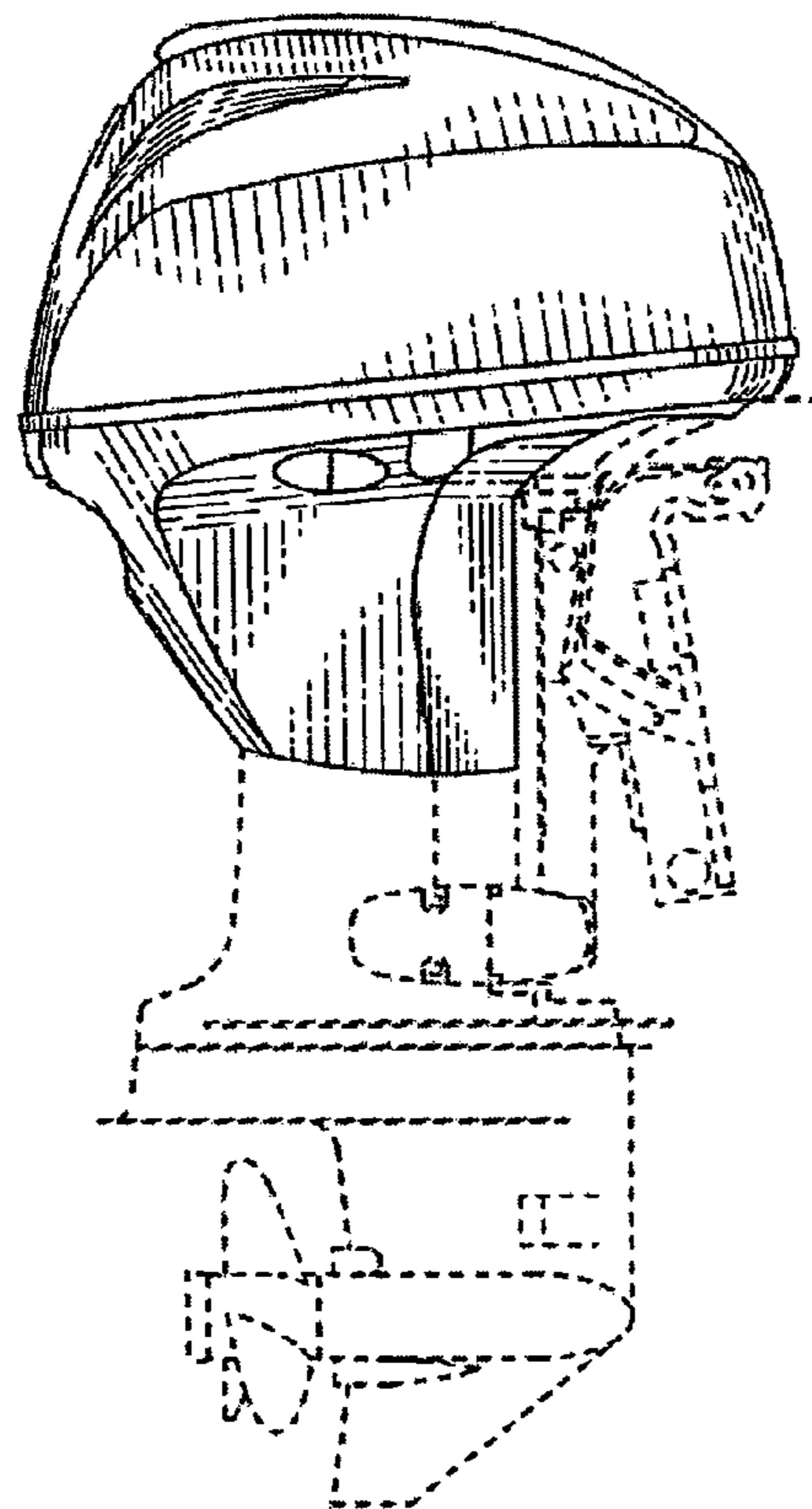

FIG. 4

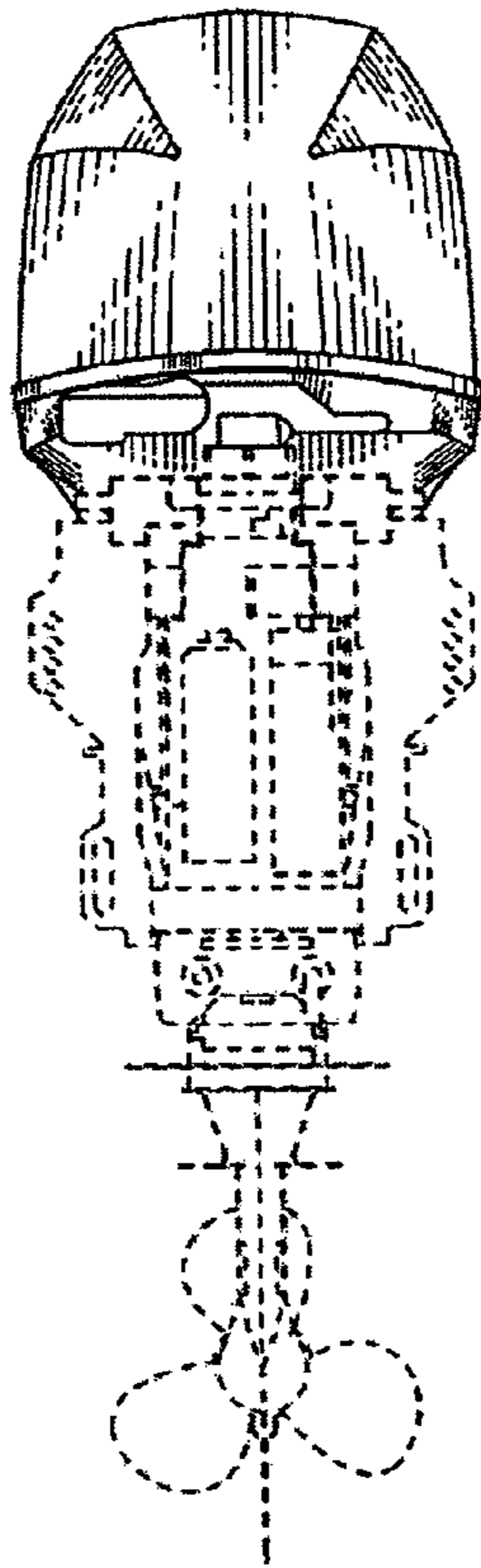

FIG. 5

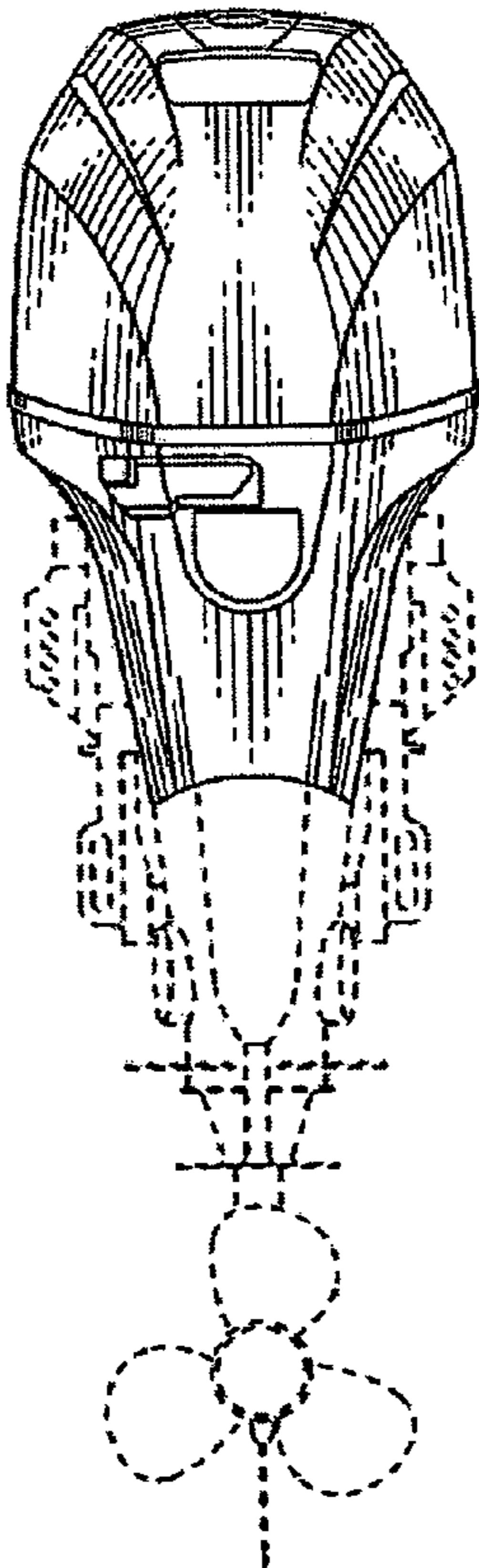

FIG. 6

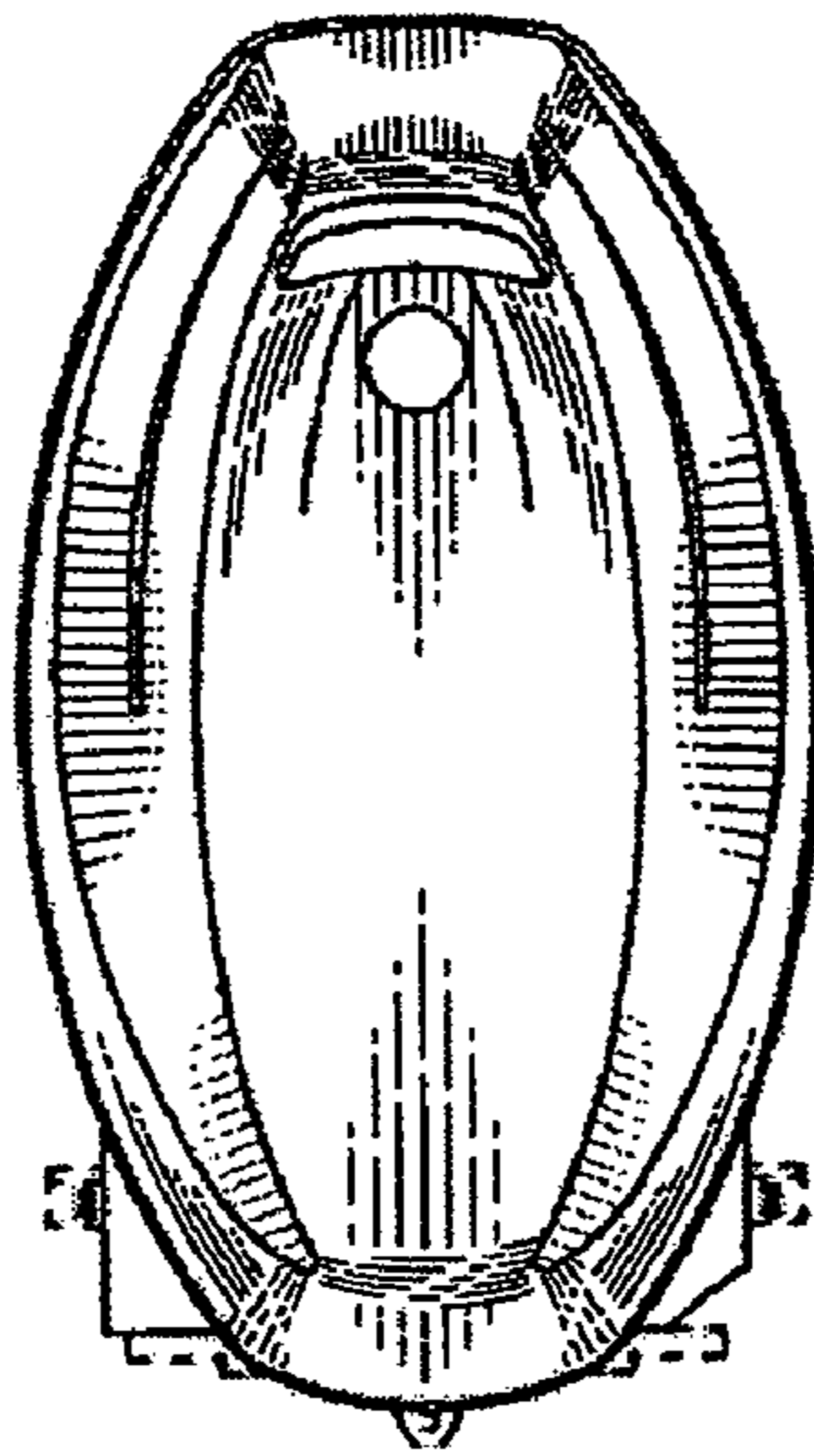

FIG. 7

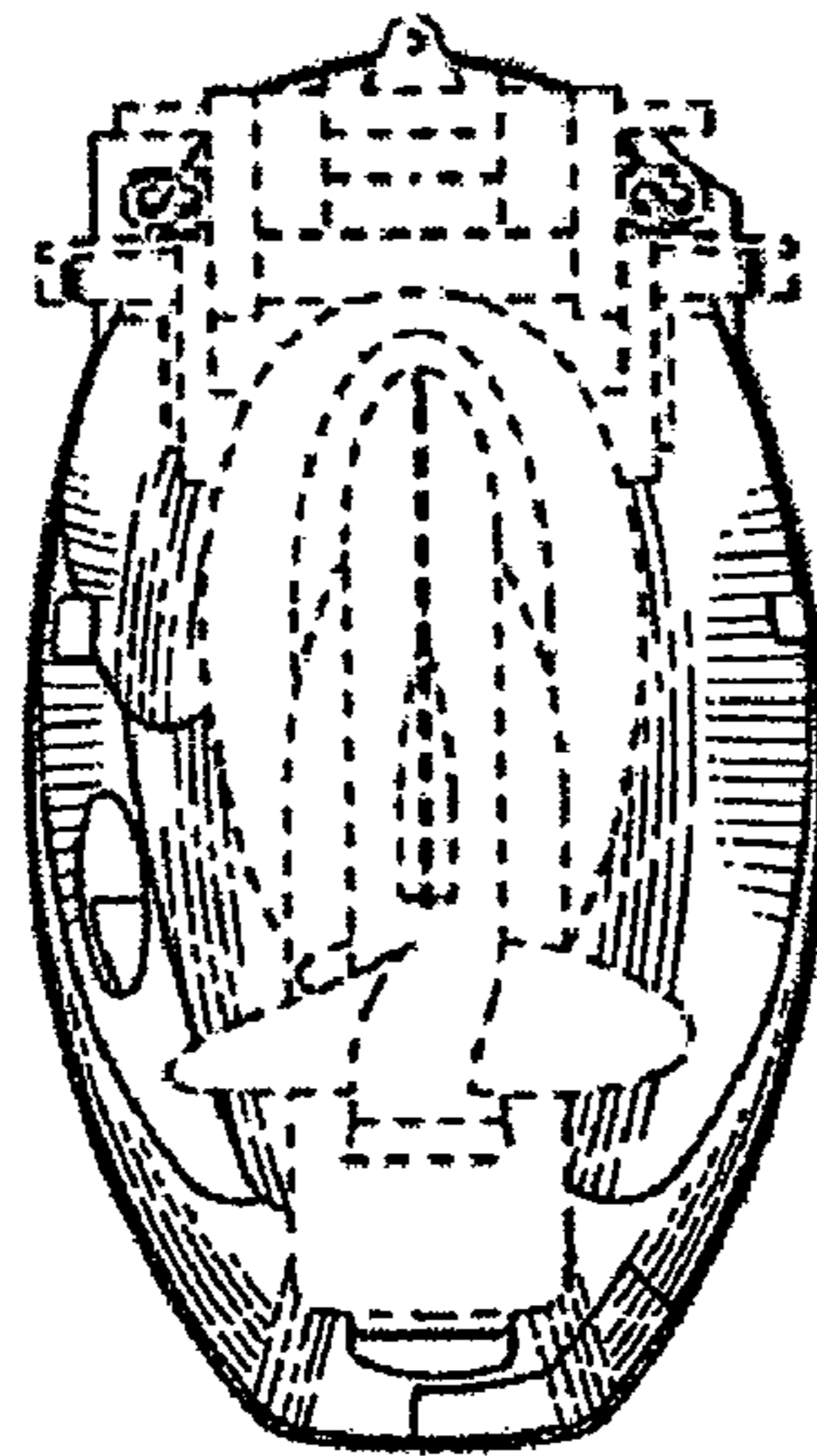

FIG. 8