



US00D589914S

(12) **United States Design Patent**
Wang et al.

(10) **Patent No.:** **US D589,914 S**
(45) **Date of Patent:** **** Apr. 7, 2009**

(54) **DIGITAL MEDIA ADAPTER**

(75) Inventors: **Qun Wang**, Shenzhen (CN); **Hong-Jin Wu**, Shenzhen (CN); **Chun-Wen Wang**, Taipei Hsien (TW)

(73) Assignee: **Hon Hai Precision Industry Co., Ltd.**, Tu-Cheng, Taipei Hsien (TW)

(**) Term: **14 Years**

(21) Appl. No.: **29/321,033**

(22) Filed: **Jul. 9, 2008**

(51) **LOC (9) Cl.** **14-03**

(52) **U.S. Cl.** **D14/125**

(58) **Field of Classification Search** D14/125-134,
D14/239, 371, 136, 374-377; 312/7.2; 348/836,
348/838, 180, 184, 325, 739; 341/12; 248/917-924,
248/465, 123.11; 345/104, 133, 156, 168,
345/87, 173, 169; 349/1, 2, 11, 62; 720/605,
720/669, 600, 655, 99, 197; 455/344-347
See application file for complete search history.

(56) **References Cited**

U.S. PATENT DOCUMENTS

D479,238 S * 9/2003 Brown D14/388
D490,796 S * 6/2004 Allen D14/507
D541,272 S * 4/2007 Wang D14/356

D545,768 S * 7/2007 Hsu D13/147
D556,199 S * 11/2007 Song D14/357
D559,209 S * 1/2008 Ahmad-Taylor et al. ... D14/125
D577,693 S * 9/2008 King et al. D14/125

* cited by examiner

Primary Examiner—Raphael Barkai

Assistant Examiner—Randall H Gholson

(74) *Attorney, Agent, or Firm*—D. Austin Bonderer

(57) **CLAIM**

The ornamental design for “digital media adapter,” as shown and described.

DESCRIPTION

FIG. 1 is a perspective view of the design for the “digital media adapter” front bezel;

FIG. 2 is a front elevational view thereof;

FIG. 3 is a left side elevational view thereof;

FIG. 4 is a right side elevational view thereof;

FIG. 5 is a top plan view thereof; and,

FIG. 6 is a bottom plan view thereof.

The broken line showing of “digital media adapter” is for the purpose of illustrating environmental structures only and forms no part of the claimed design.

1 Claim, 6 Drawing Sheets

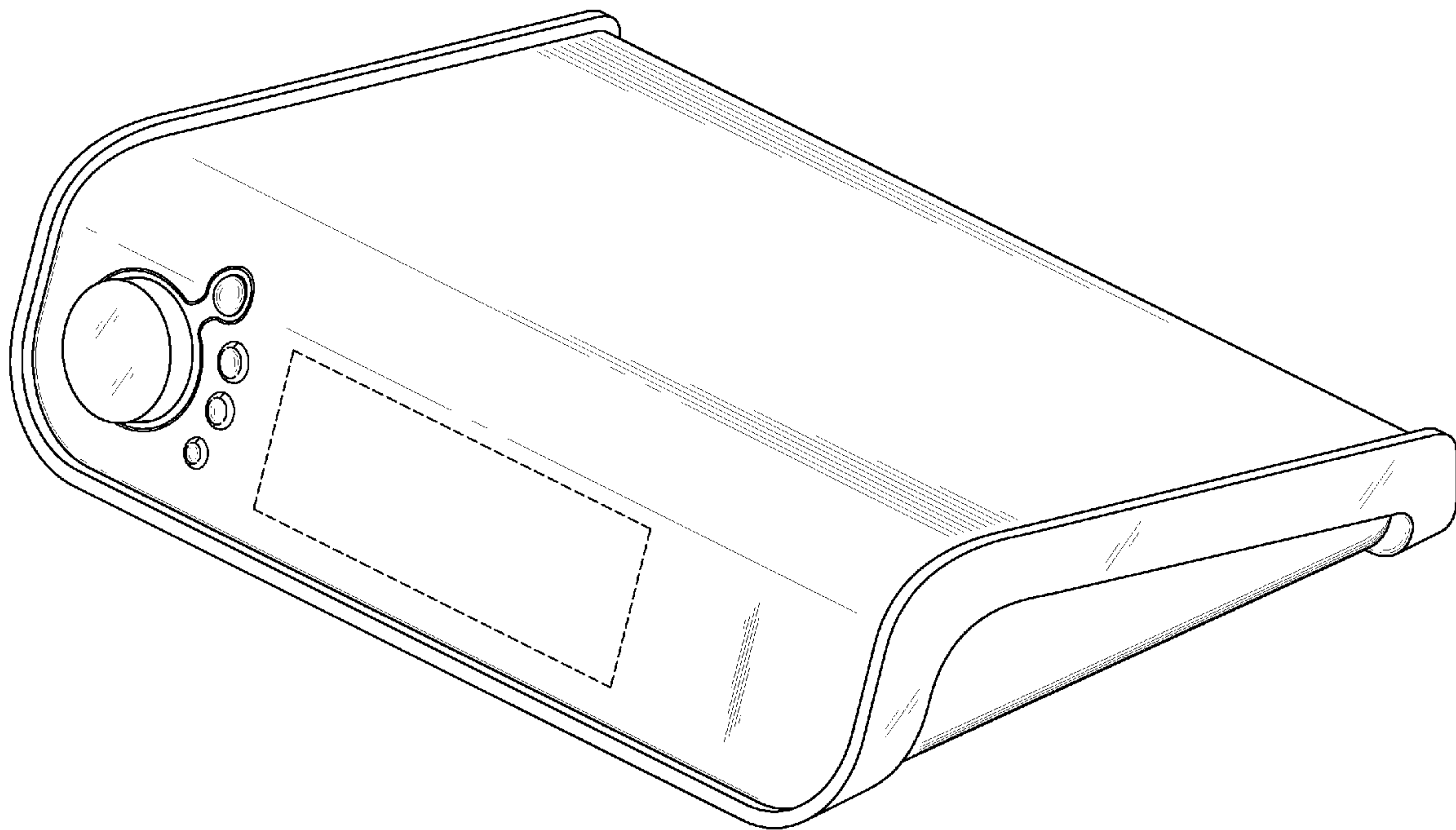

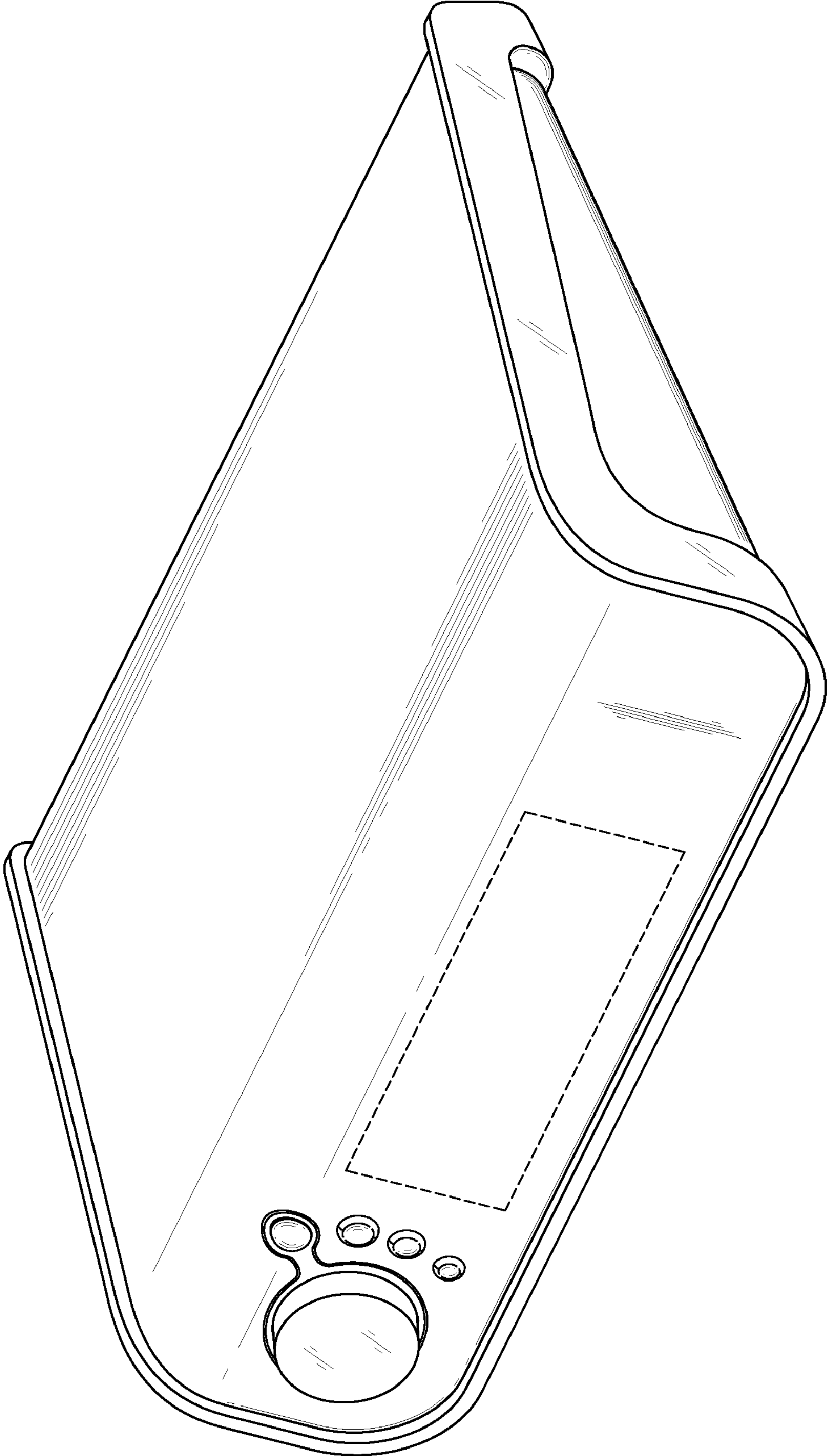

FIG. 1

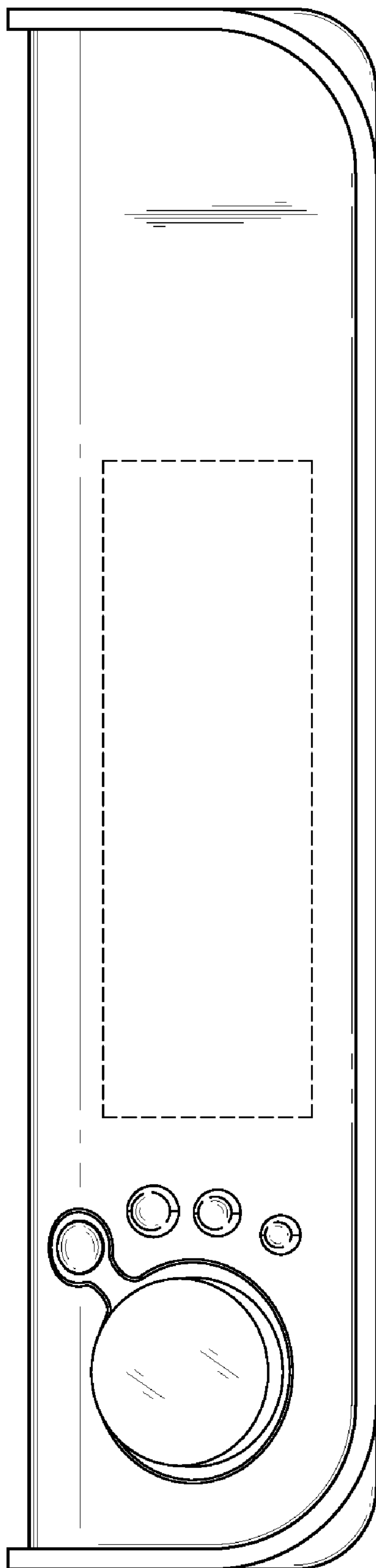

FIG. 2

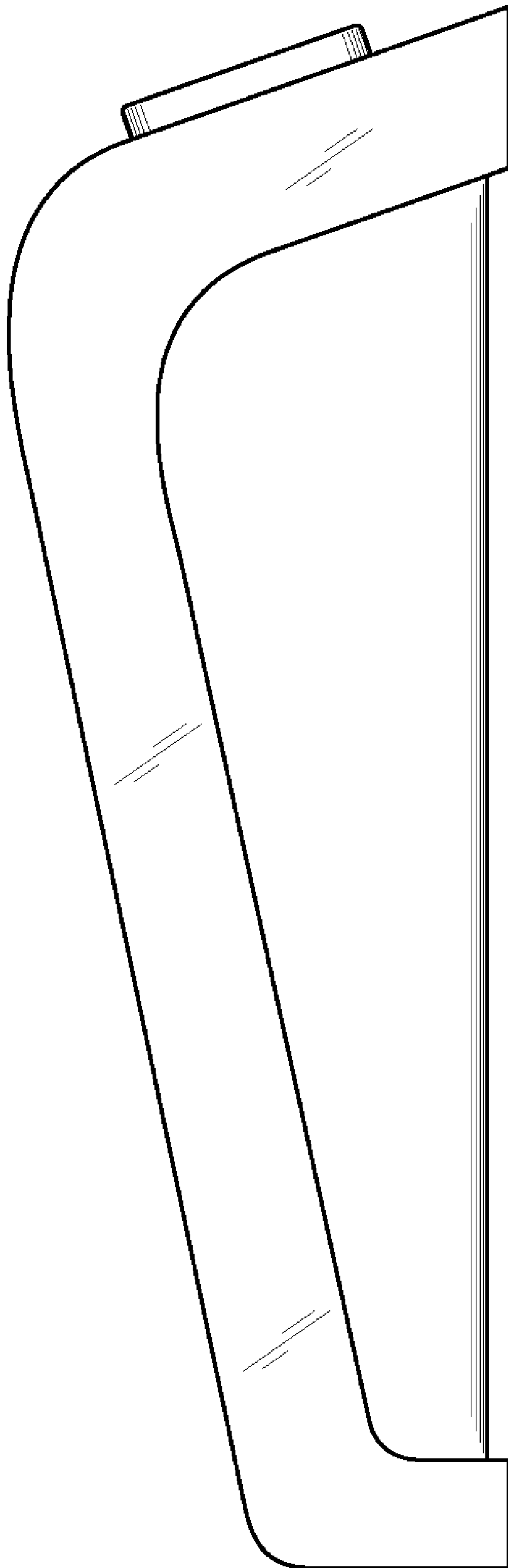

FIG. 3

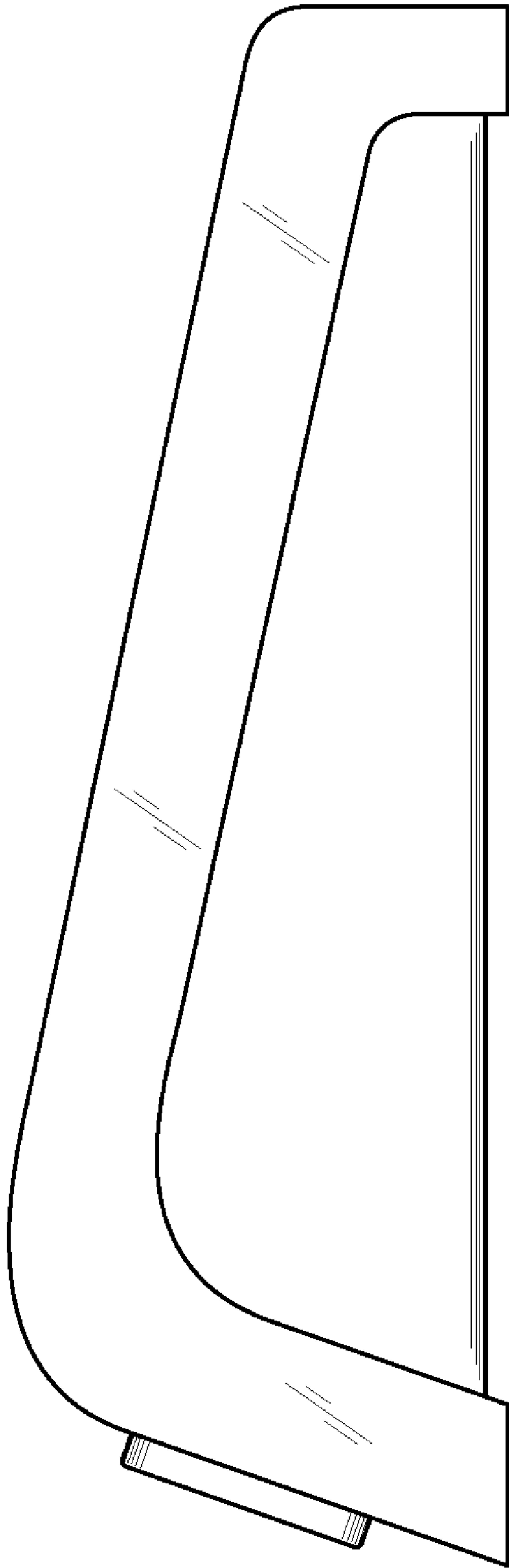

FIG. 4

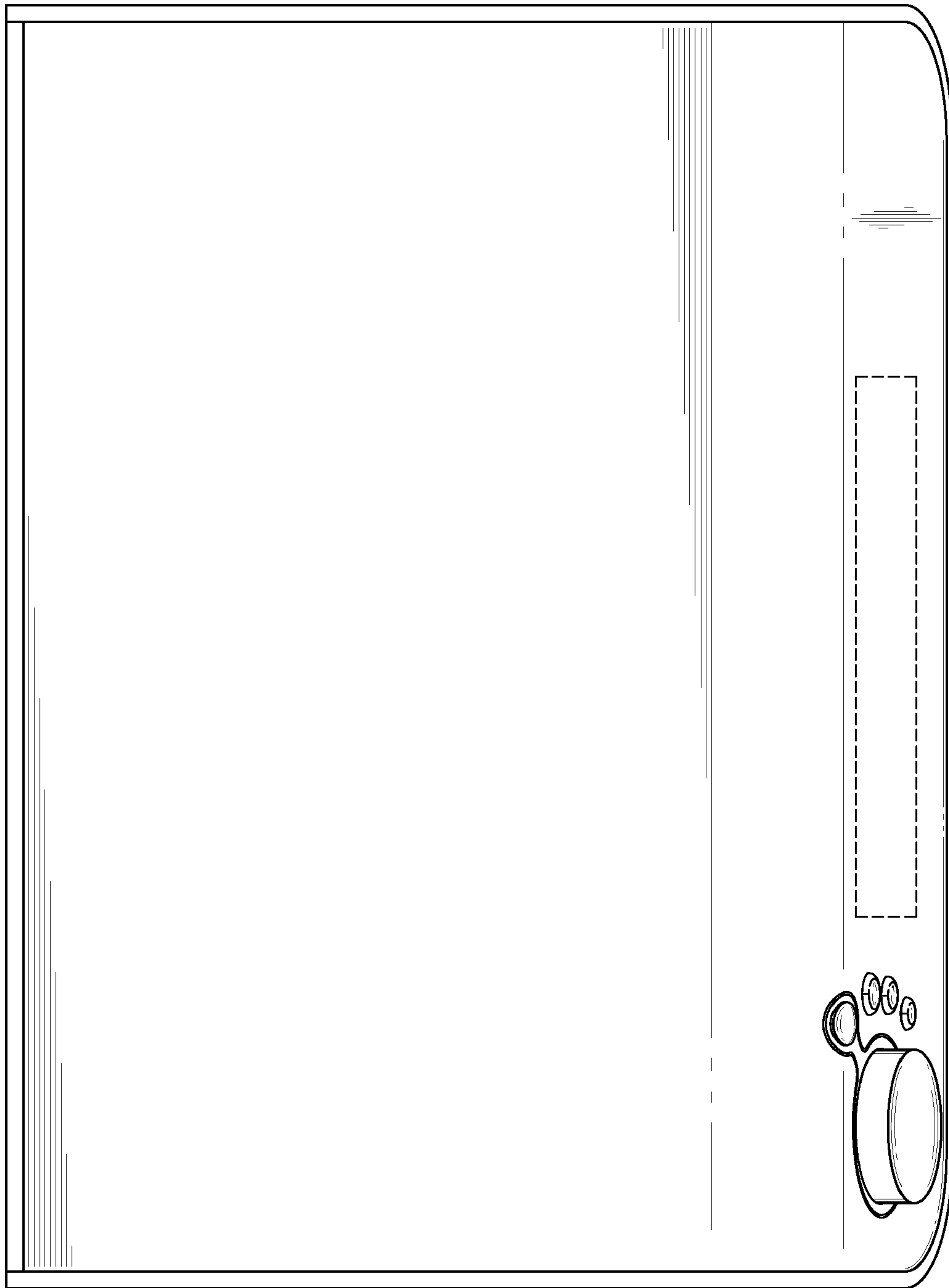

FIG. 5

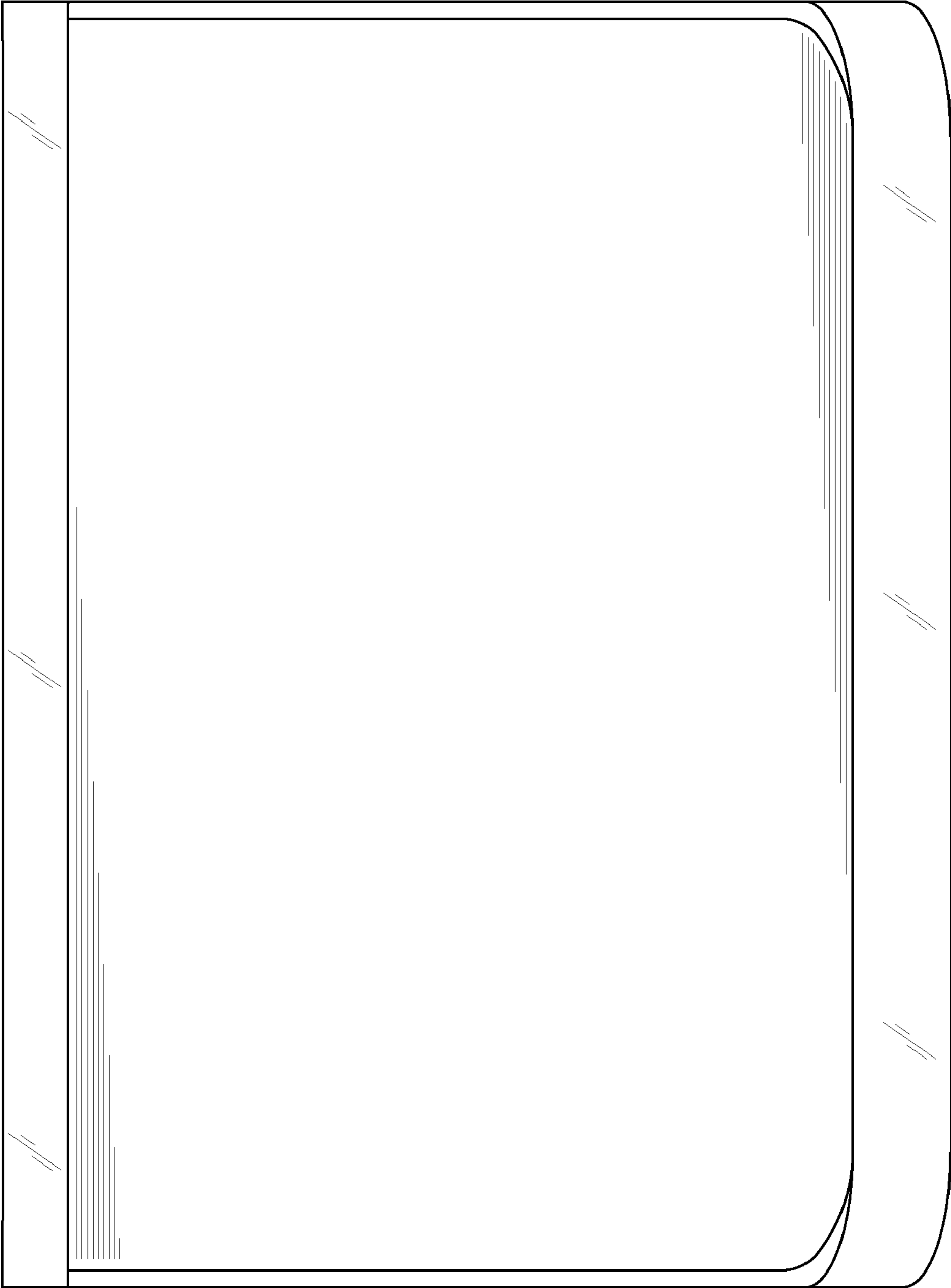

FIG. 6