



US00D589899S

(12) **United States Design Patent**
Huang et al.

(10) **Patent No.:** **US D589,899 S**

(45) **Date of Patent:** **** Apr. 7, 2009**

(54) **PLUG CONNECTOR**

D562,244 S * 2/2008 Peng D13/147
D580,365 S * 11/2008 Peng D13/147

(75) Inventors: **Sheng Yuan Huang**, Tu-Cheng (TW);
Sheng Tsung Yuan, Tu-Cheng (TW);
Yung Chi Peng, Tu-Cheng (TW)

* cited by examiner

Primary Examiner—Daniel D Bui

(73) Assignee: **Cheng Uei Precision Industry Co., Ltd.**, Taipei Hsien (TW)

(74) *Attorney, Agent, or Firm*—Rosenberg, Klein & Lee

(**) Term: **14 Years**

(57) **CLAIM**

(21) Appl. No.: **29/309,705**

The ornamental design for a plug connector, as shown and described.

(22) Filed: **Sep. 29, 2008**

DESCRIPTION

(51) **LOC (9) Cl.** **13-03**

FIG. 1 is a perspective view of a plug connector showing our new design;

(52) **U.S. Cl.** **D13/147**

FIG. 2 is a front elevational view thereof;

(58) **Field of Classification Search** D13/146–147,
D13/154, 184; D14/432–433, 435, 438;
439/64, 79, 108, 260, 159–160, 325–326,
439/329, 394–395, 492–499, 607–610, 629–630,
439/660

FIG. 3 is a rear elevational view thereof;

FIG. 4 is a left side elevational view thereof;

FIG. 5 is a right side elevational view thereof;

See application file for complete search history.

FIG. 6 is a top plan view thereof;

FIG. 7 is a bottom plan view thereof; and,

FIG. 8 is another perspective view of the plug connector showing our new design.

(56) **References Cited**

U.S. PATENT DOCUMENTS

D528,987 S * 9/2006 Peng D13/147
D544,447 S * 6/2007 Peng et al. D13/147

1 Claim, 8 Drawing Sheets

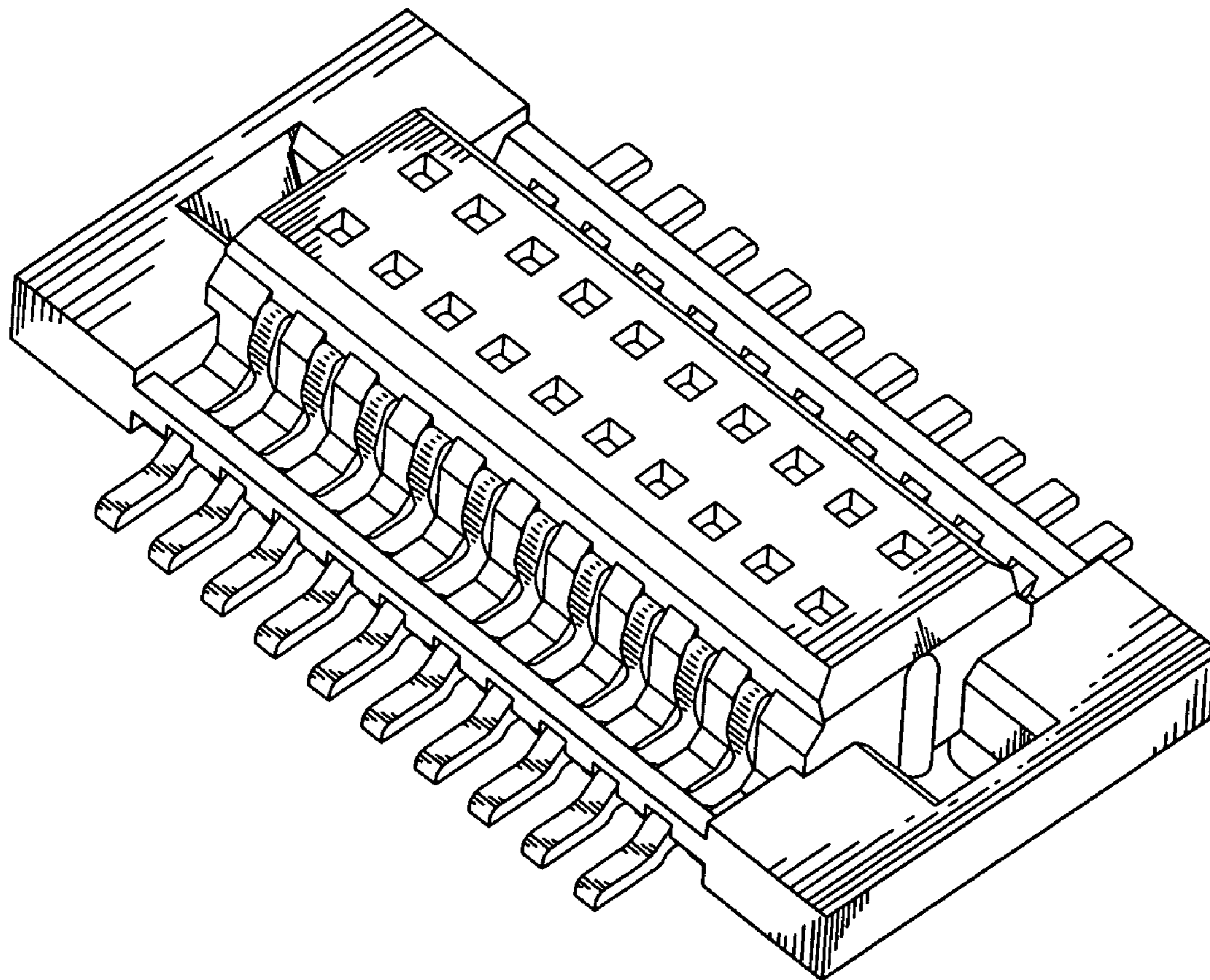

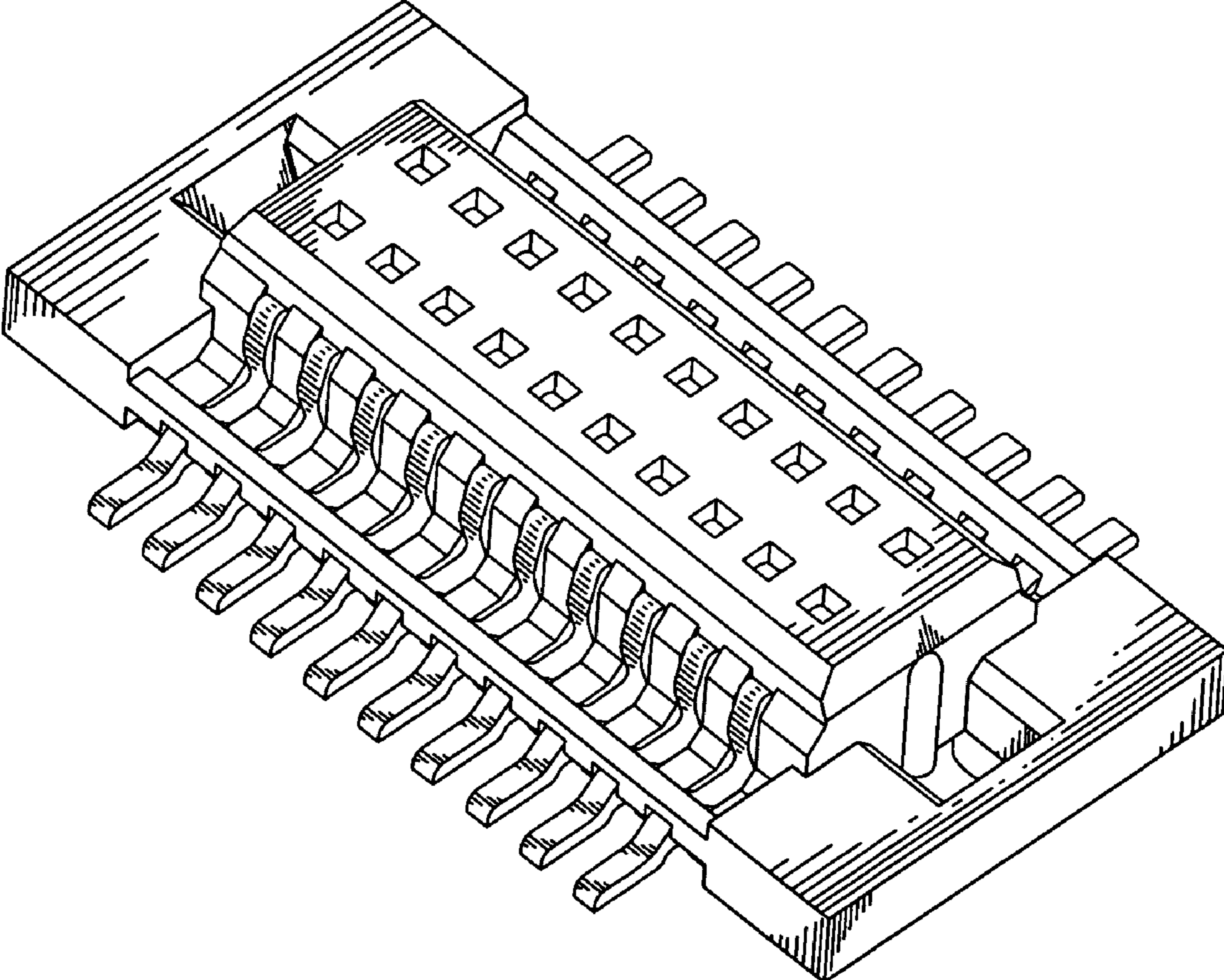

FIG. 1

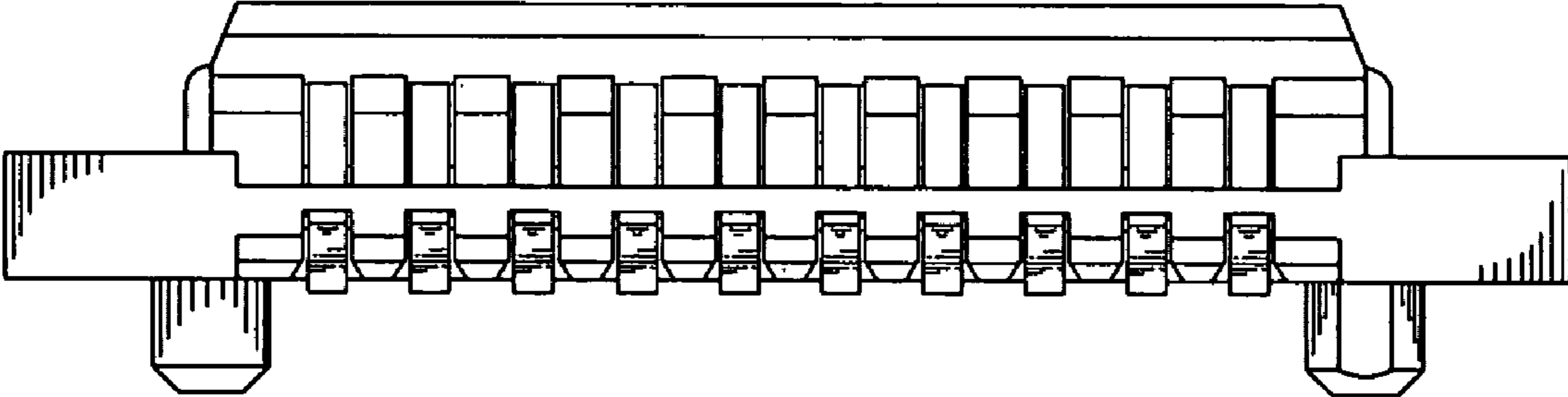

FIG. 2

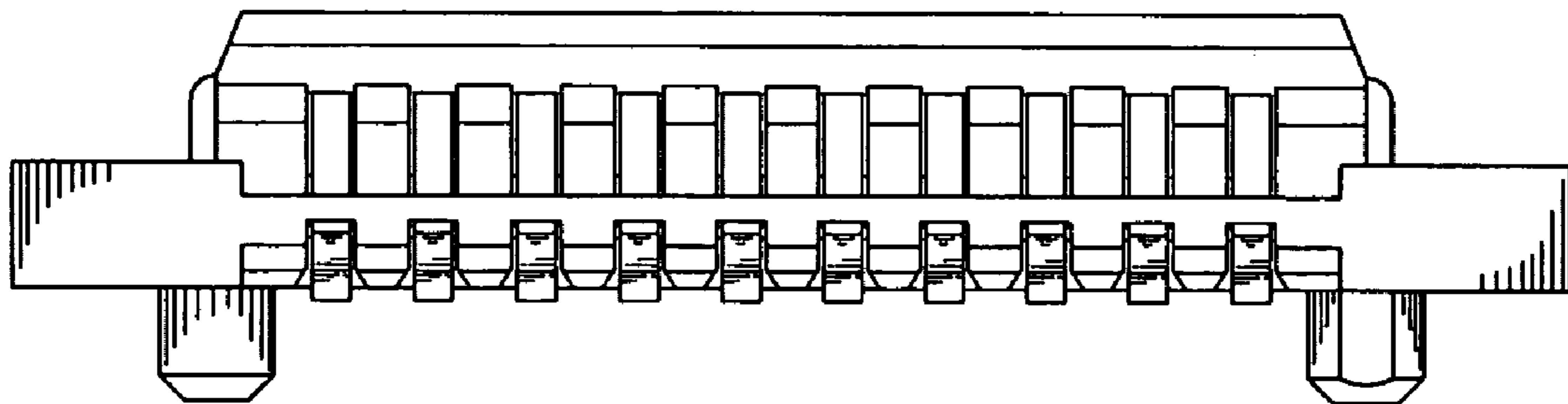

FIG. 3

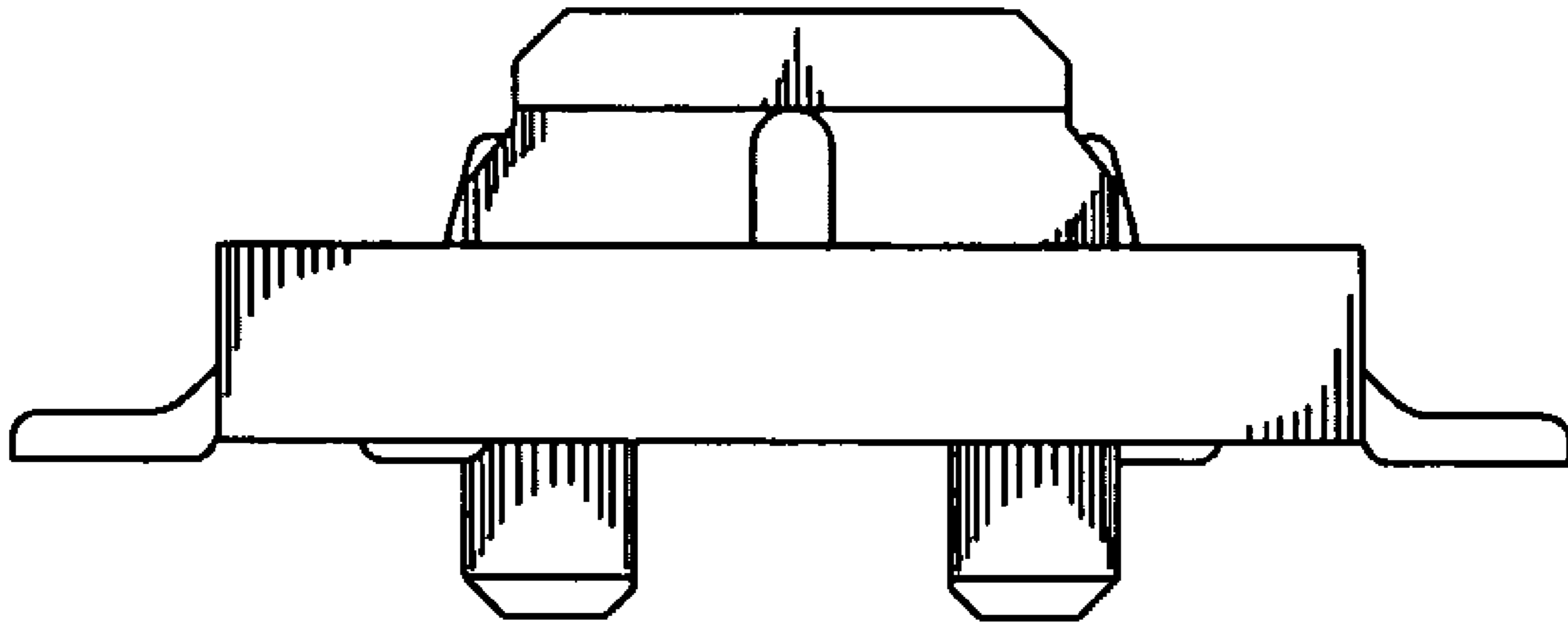

FIG. 4

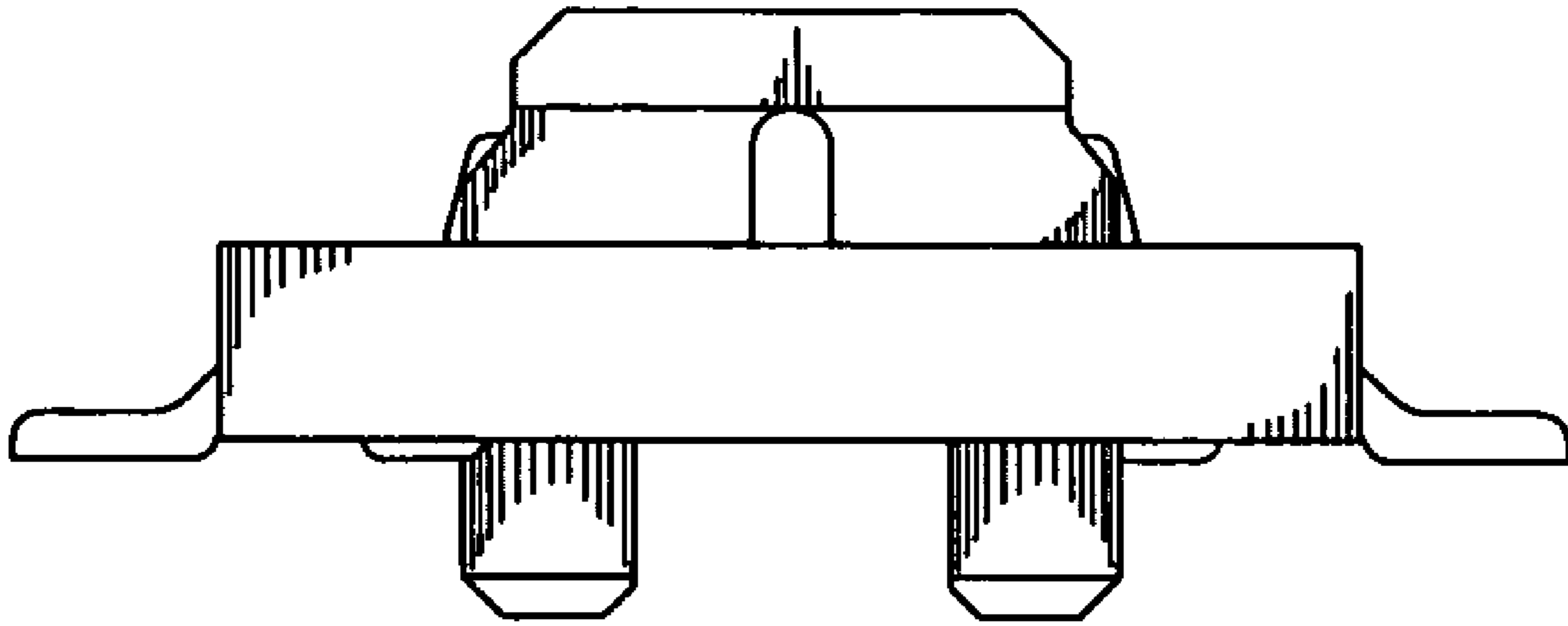

FIG. 5

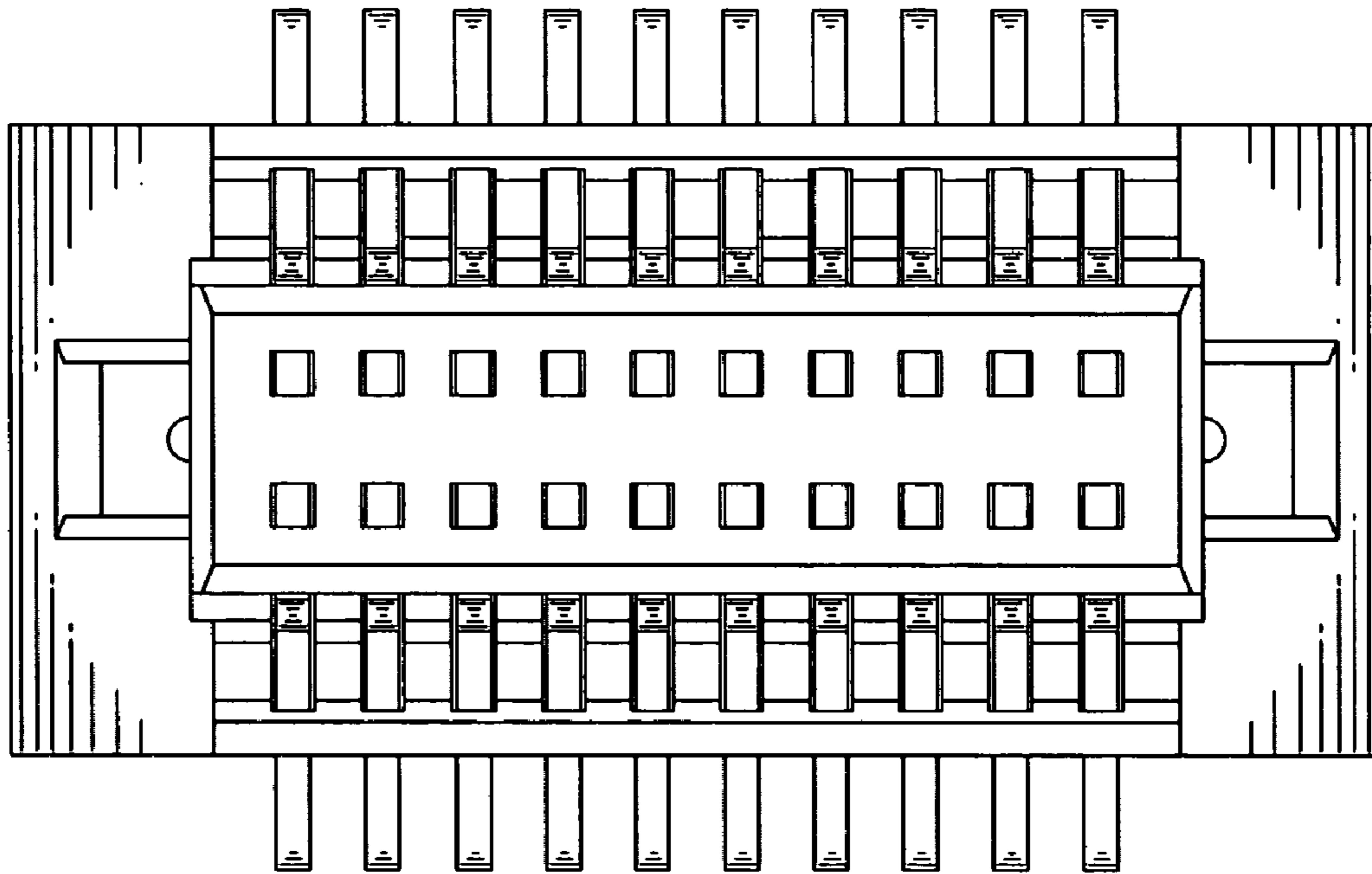

FIG. 6

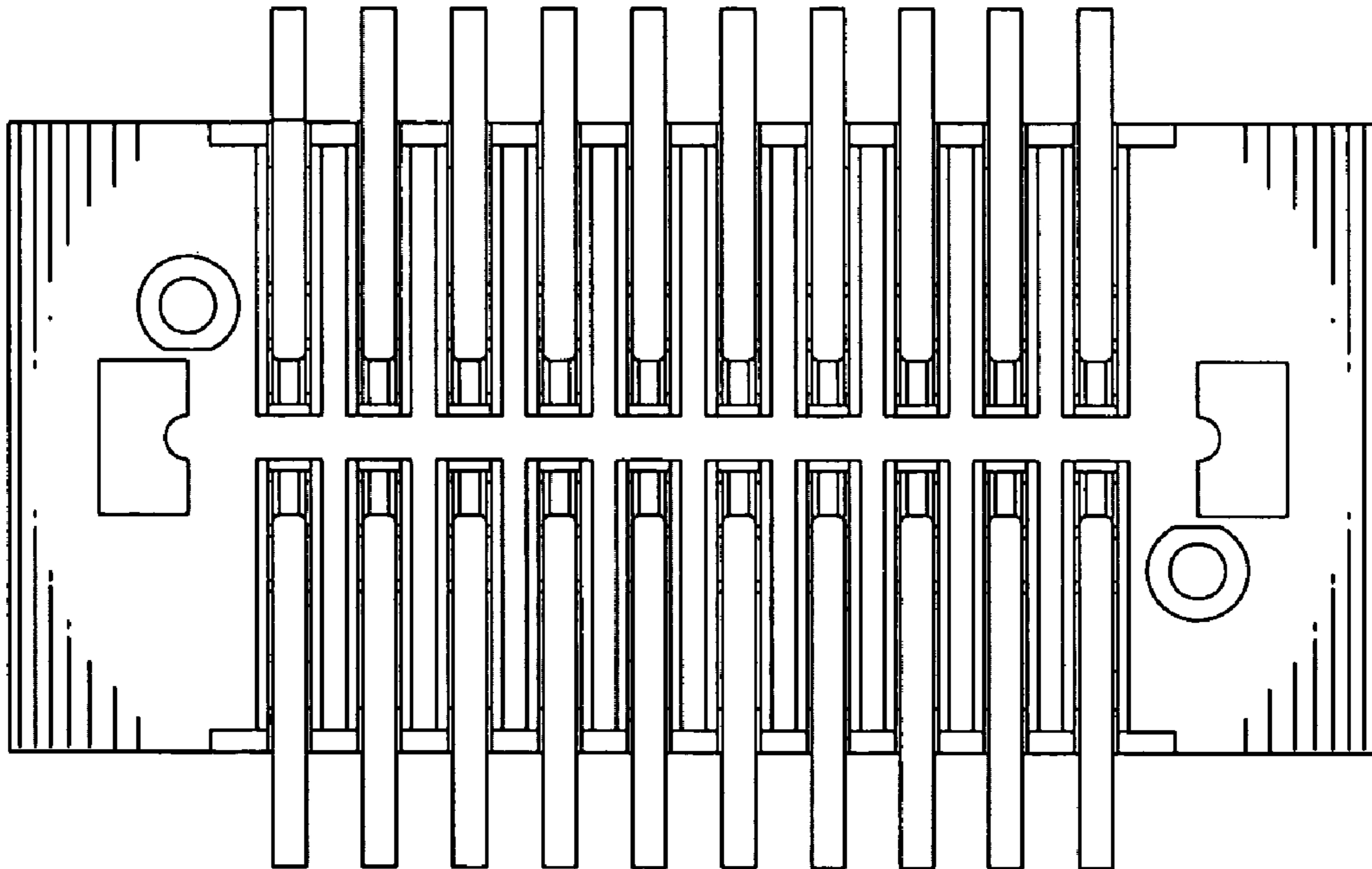

FIG. 7

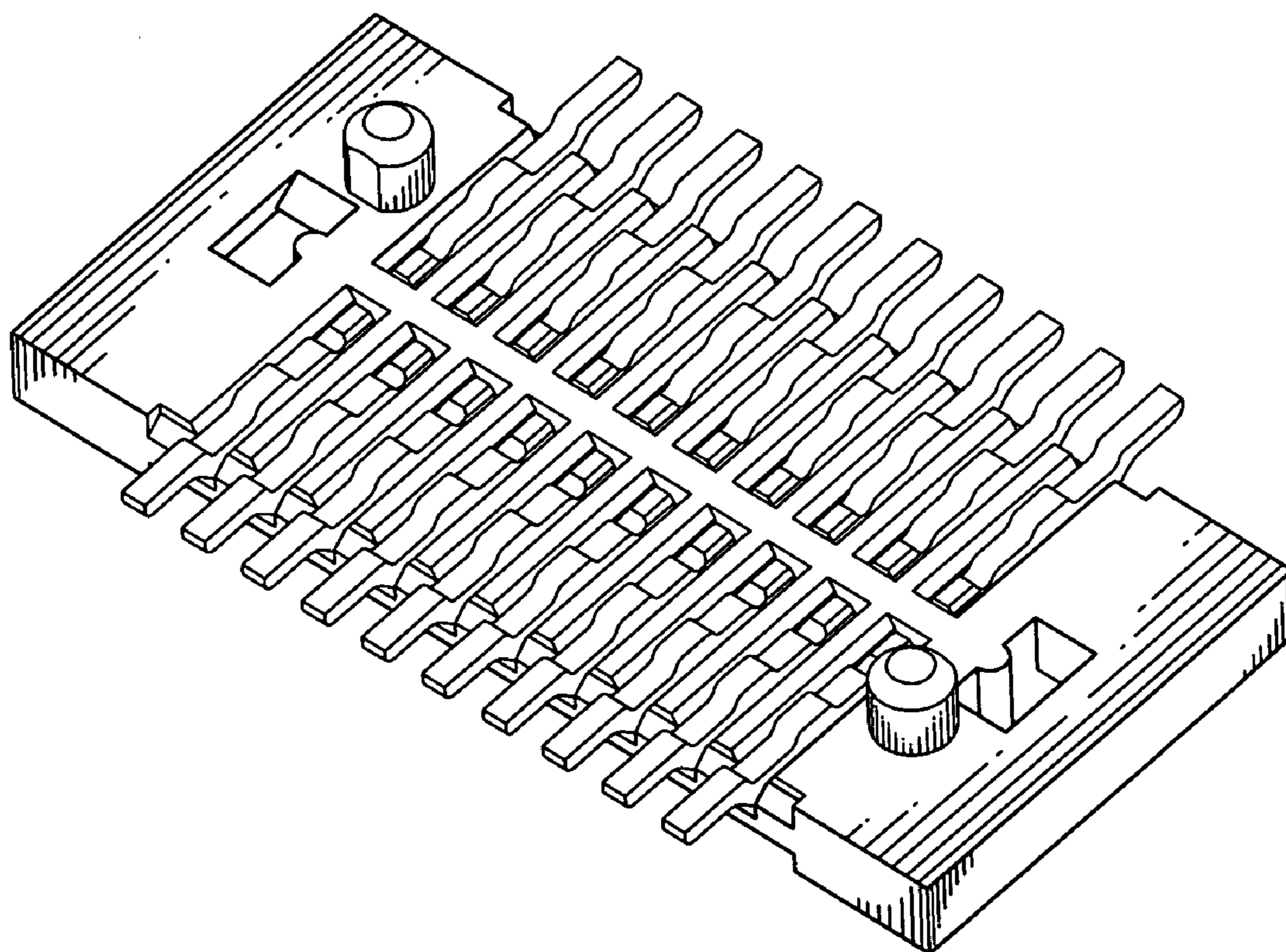

FIG. 8