



US00D589894S

(12) **United States Design Patent**
Hung et al.

(10) **Patent No.:** **US D589,894 S**

(45) **Date of Patent:** **** Apr. 7, 2009**

(54) **CARD CONNECTOR**

(75) Inventors: **Pei Chiao Hung**, Tu-Cheng (TW); **Hsin Tsung Ho**, Tu-Cheng (TW); **Shu Man Chiang**, Tu-Cheng (TW)

(73) Assignee: **Cheng Uei Precision Industry Co., Ltd.**, Taipei Hsien (TW)

(**) Term: **14 Years**

(21) Appl. No.: **29/309,270**

(22) Filed: **Jul. 17, 2008**

(51) **LOC (9) Cl.** **13-03**

(52) **U.S. Cl.** **D13/147**

(58) **Field of Classification Search** D13/147,
D13/154, 184; D14/432, 433, 436, 438;
361/684-685; 439/64, 79, 159-160, 330,
439/331, 341-342, 607-610, 629-630, 660,
439/946

See application file for complete search history.

(56) **References Cited**

U.S. PATENT DOCUMENTS

D423,457 S *	4/2000	Konno et al.	D13/147
D529,446 S *	10/2006	Su	D13/147
D544,842 S *	6/2007	Nishio et al.	D13/147
D559,787 S *	1/2008	Sasaki et al.	D13/147
D566,655 S *	4/2008	Chen et al.	D13/147

D568,250 S *	5/2008	Wu et al.	D13/147
D569,346 S *	5/2008	Wu et al.	D13/147
D570,291 S *	6/2008	Zhang	D13/147

* cited by examiner

Primary Examiner—Daniel D Bui

(74) *Attorney, Agent, or Firm*—Rosenberg, Klein & Lee

(57) **CLAIM**

The ornamental design for a card connector, as shown and described.

DESCRIPTION

FIG. 1 is a perspective view of a card connector showing our new design;

FIG. 2 is a front elevational view thereof;

FIG. 3 is a rear elevational view thereof;

FIG. 4 is a left side elevational view thereof;

FIG. 5 is a right side elevational view thereof;

FIG. 6 is a top plan view thereof;

FIG. 7 is a bottom plan view thereof; and,

FIG. 8 is another perspective view of the card connector showing our new design.

The broken lines representing internal elements in the drawings is included to show unclaimed subject matter only and forms no part of the claimed design.

1 Claim, 8 Drawing Sheets

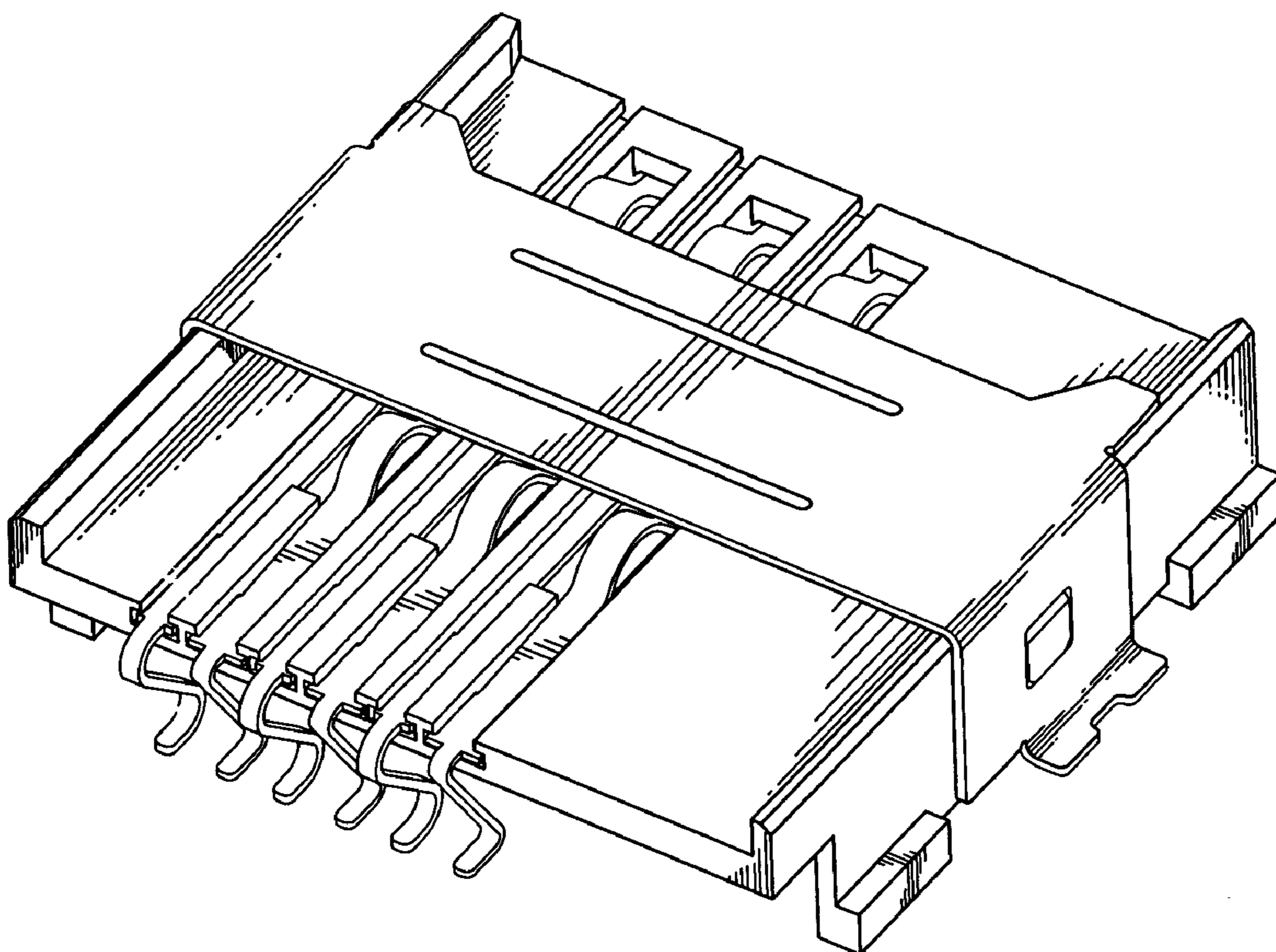

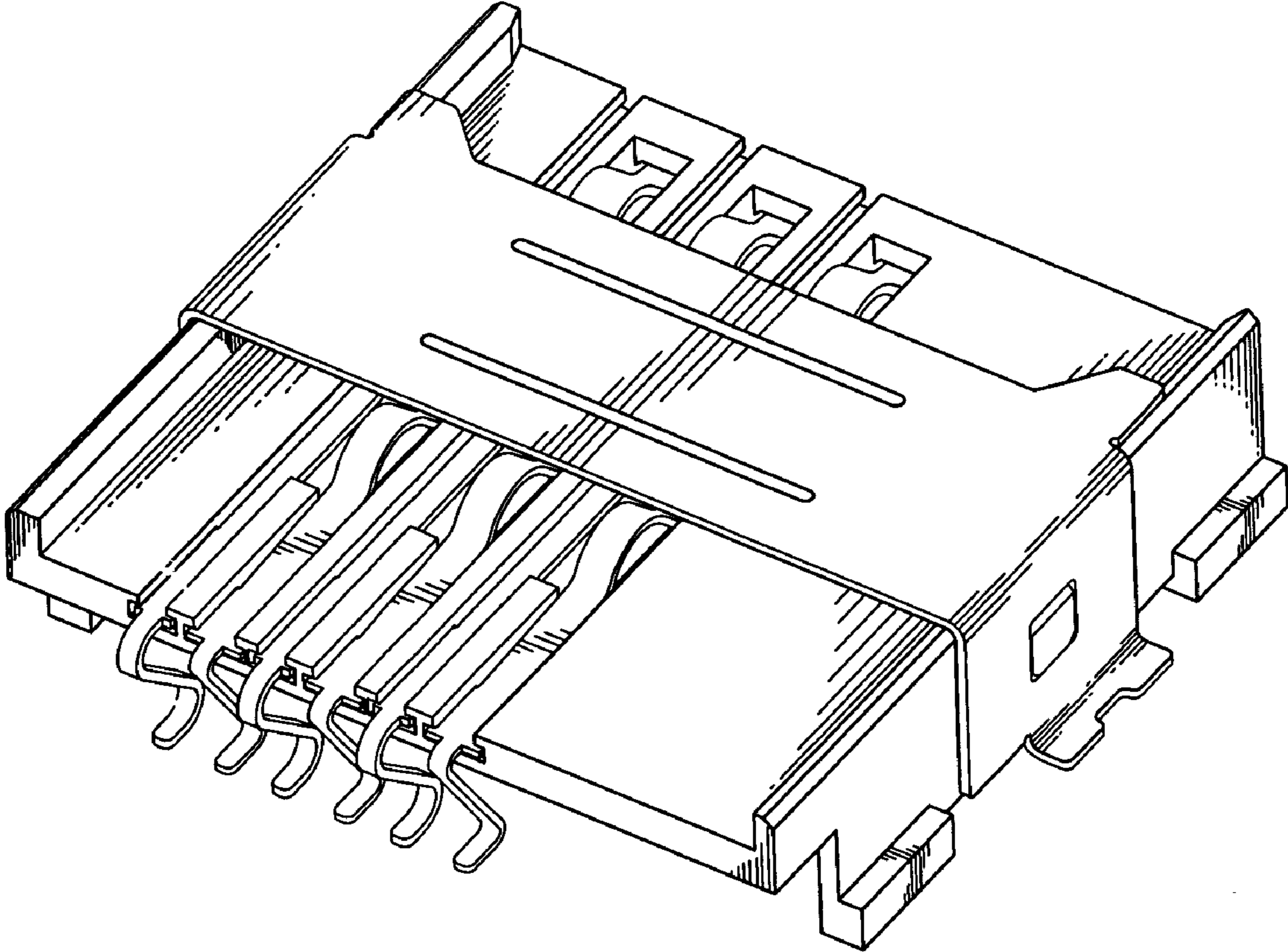

FIG. 1

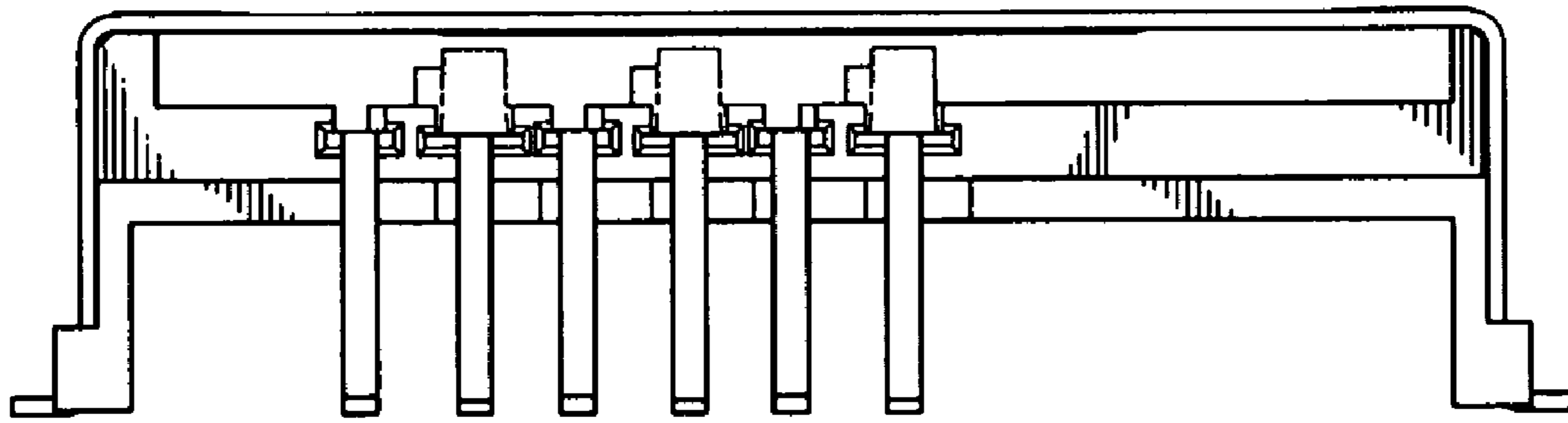

FIG. 2

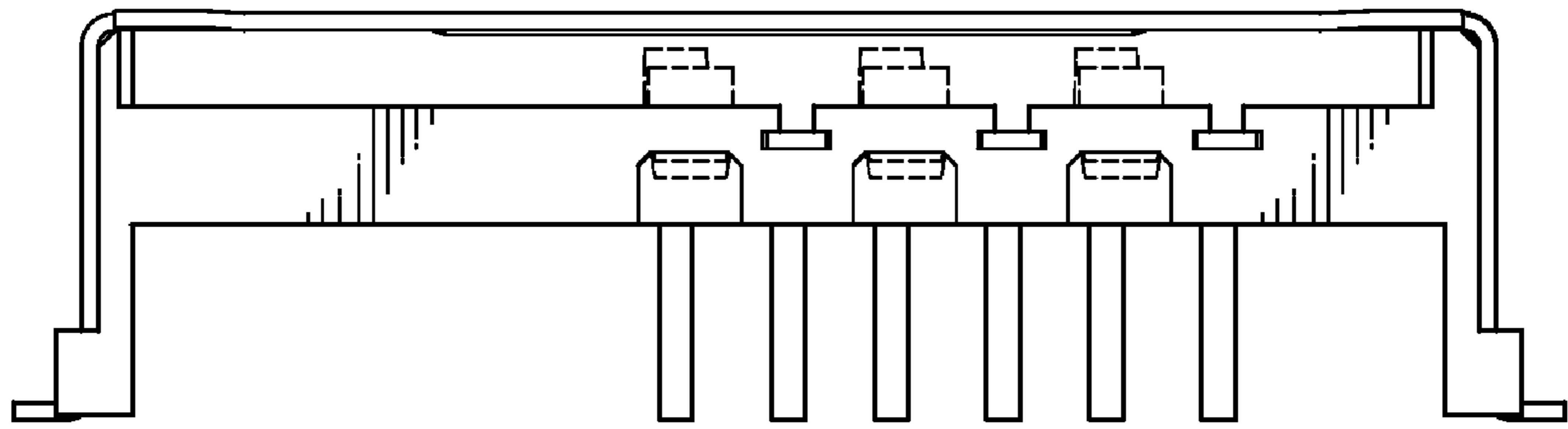

FIG. 3

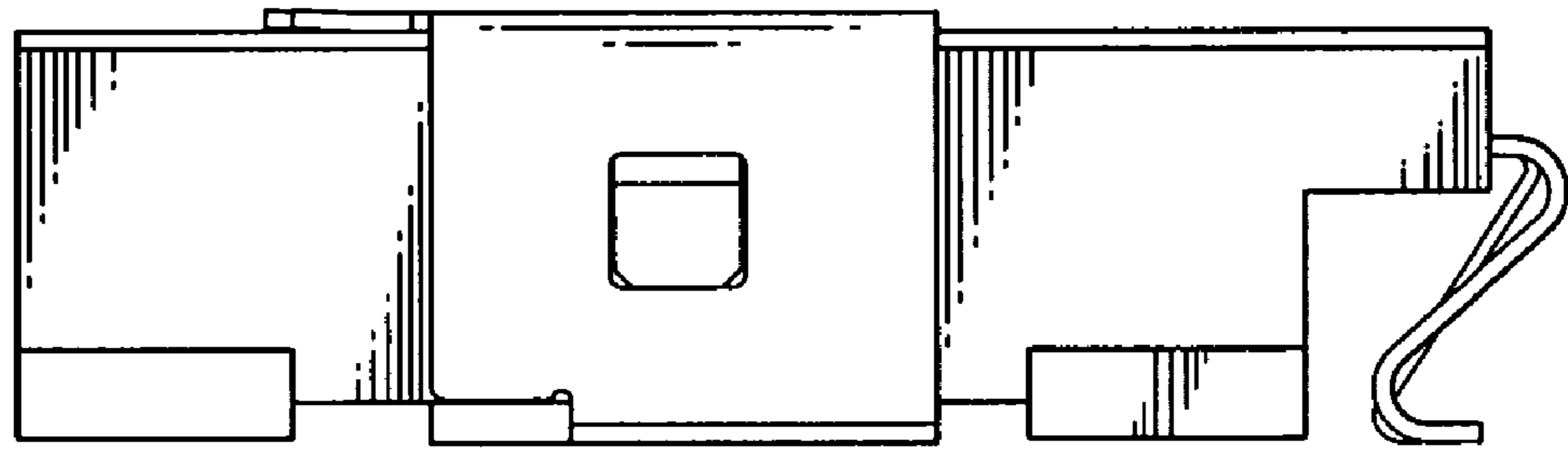

FIG. 4

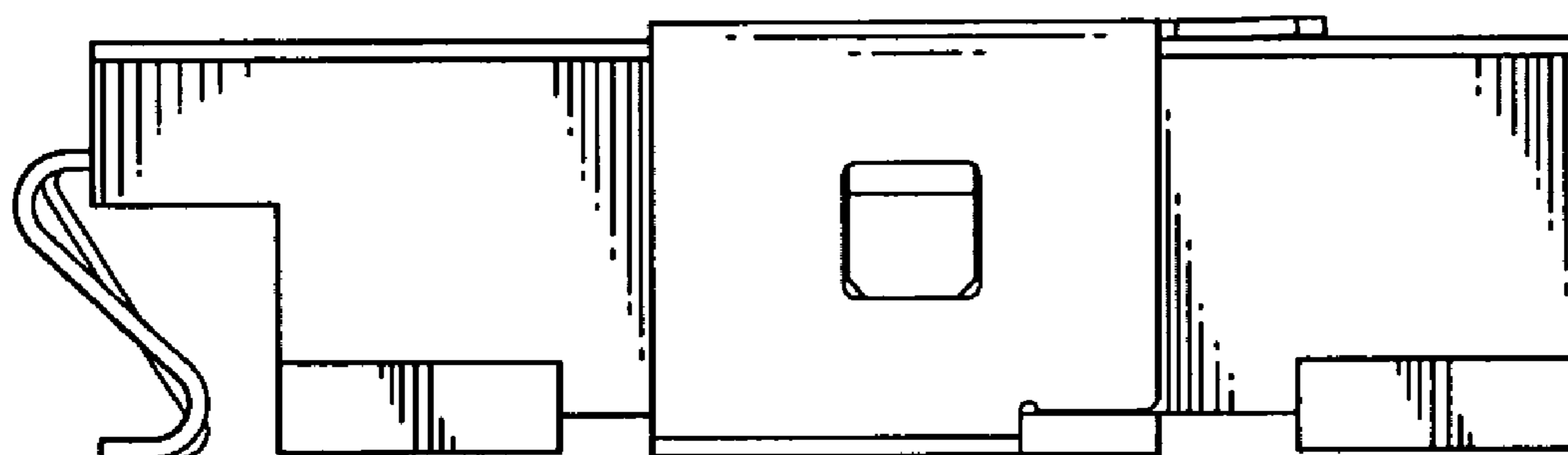

FIG. 5

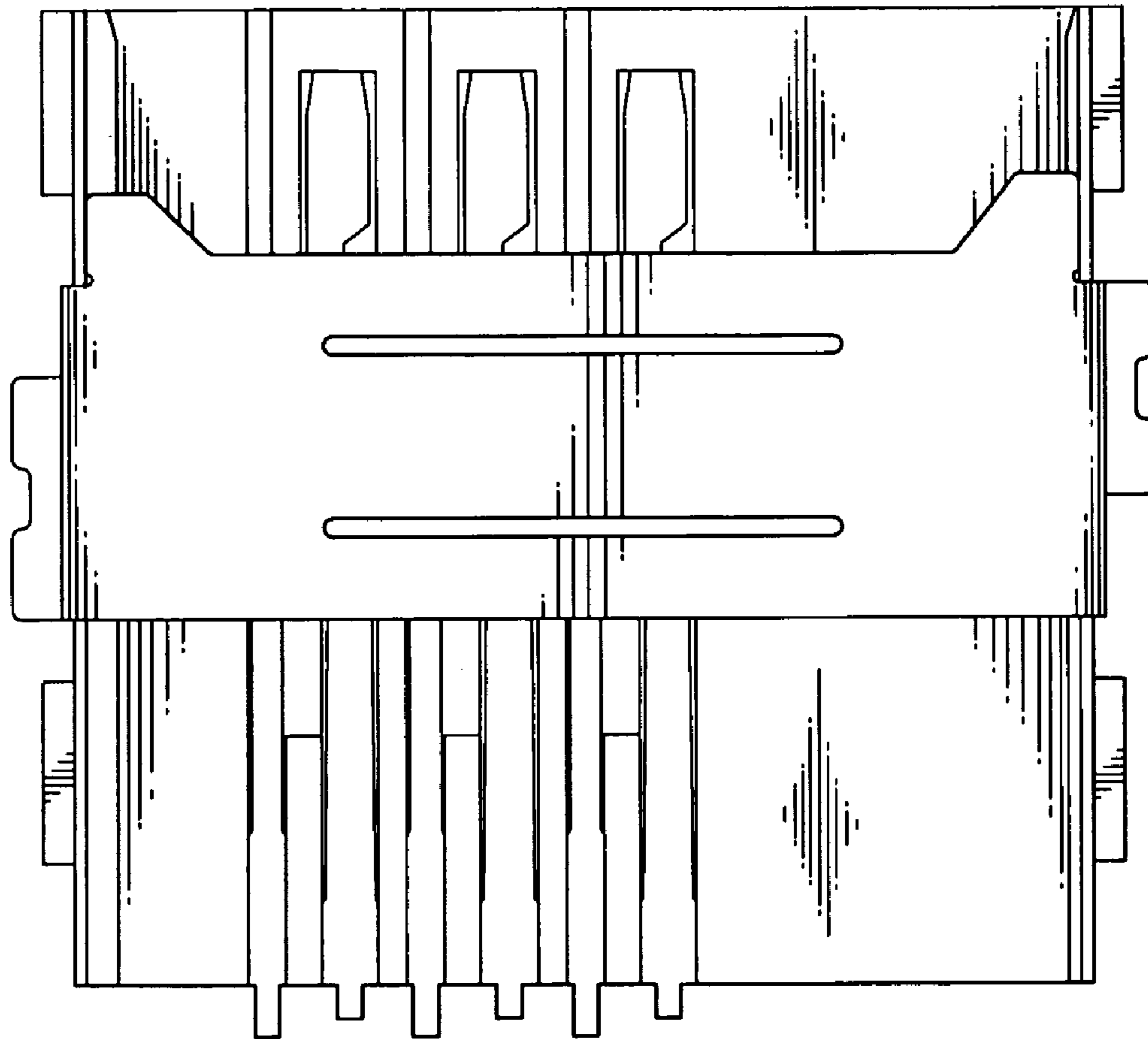

FIG. 6

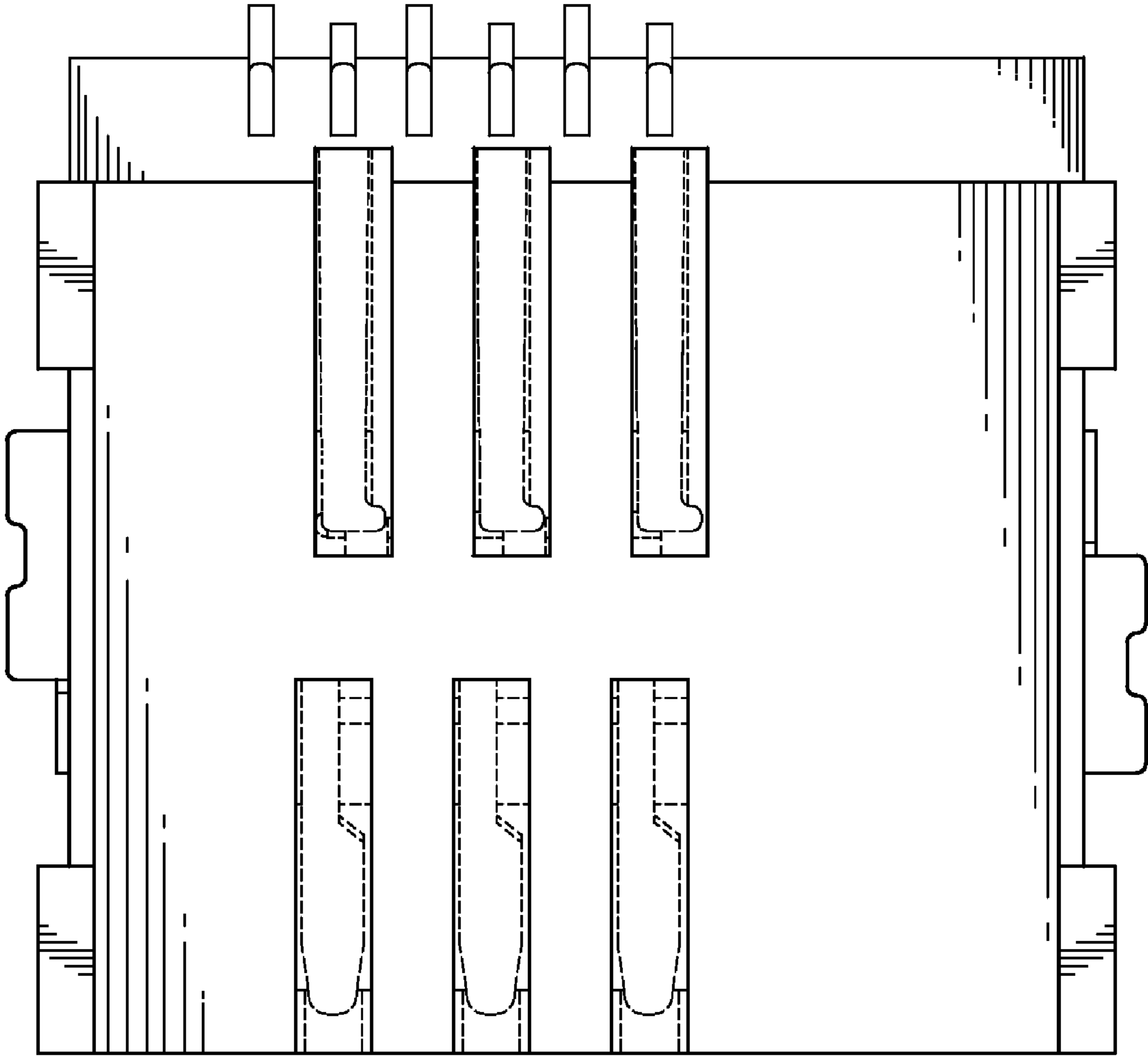

FIG. 7

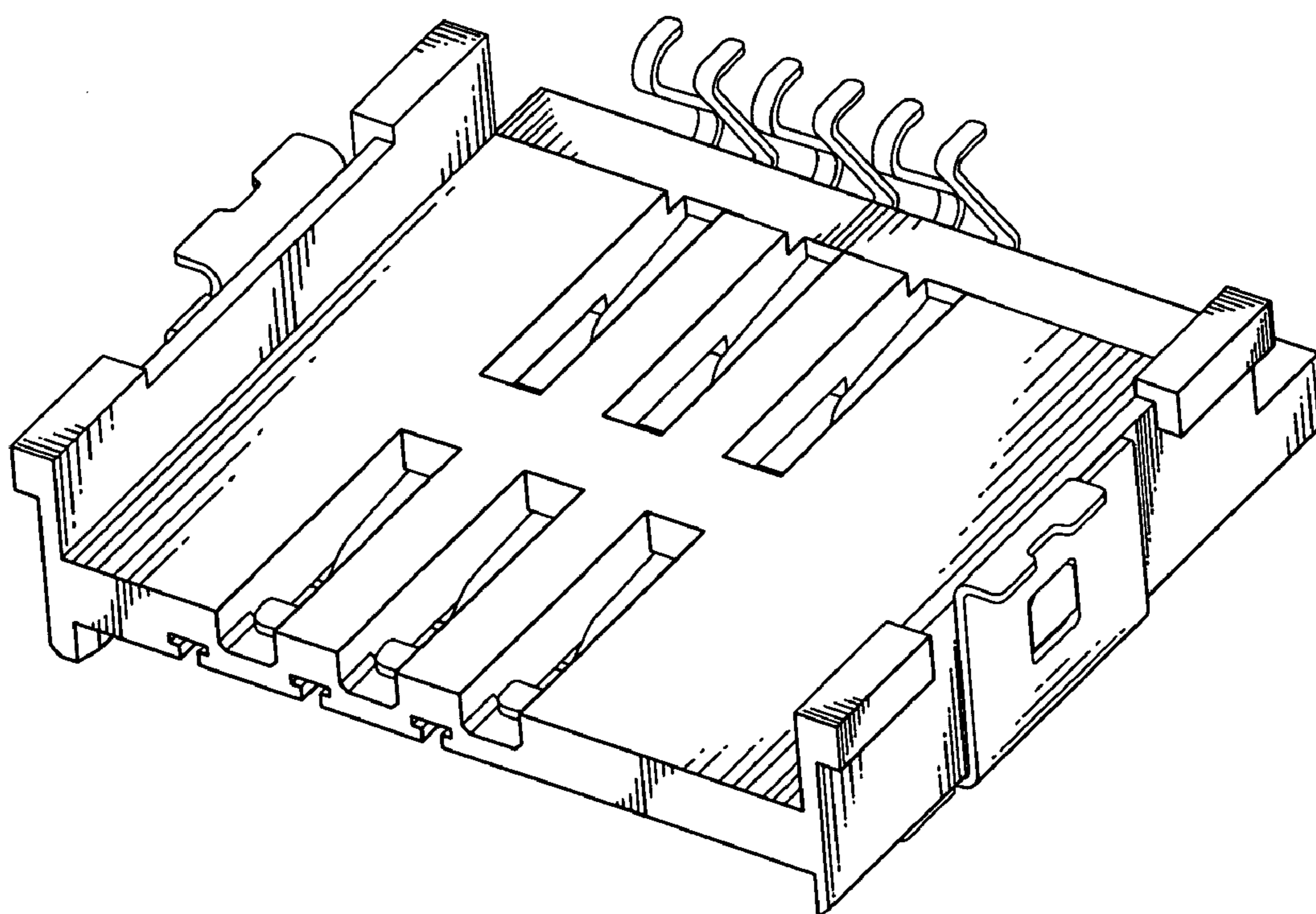

FIG. 8