



US00D589866S

(12) **United States Design Patent**
Templeman et al.

(10) **Patent No.:** **US D589,866 S**
(45) **Date of Patent:** **** Apr. 7, 2009**

(54) **BOAT STABILIZER**
(75) Inventors: **Steven W. Templeman**, Carthage, MO
(US); **Jon C. Templeman**, Overland
Park, KS (US)
(73) Assignee: **Marine Dynamics, Inc.**, Lenexa, KS
(US)
(**) Term: **14 Years**

4,377,123 A 3/1983 Jackson
4,381,725 A 5/1983 Rowan
4,487,152 A 12/1984 Larson
4,519,336 A 5/1985 Mason
4,597,742 A 7/1986 Finkl
4,676,181 A 6/1987 Oates, Jr.
4,708,672 A 11/1987 Bentz et al.
4,738,644 A 4/1988 Happel
4,744,779 A 5/1988 Koehler
4,748,927 A 6/1988 Bujacich

(Continued)

(21) Appl. No.: **29/267,179**

FOREIGN PATENT DOCUMENTS

(22) Filed: **Oct. 6, 2006**

GB 716879 10/1954

(Continued)

(51) **LOC (9) Cl.** **12-06**

(52) **U.S. Cl.** **D12/317**

(58) **Field of Classification Search** D12/230.26,
D12/300, 317; 440/66, 51, 42; 114/274,
114/284, 280, 281, 285-287, 125, 126

See application file for complete search history.

OTHER PUBLICATIONS

Jon C. Templeman, U.S. Appl. No. 10/749,147, filed Dec. 30, 2003.

(Continued)

(56) **References Cited**

U.S. PATENT DOCUMENTS

2,021,309 A 11/1935 Irgens
2,319,640 A 5/1943 Sink
2,963,000 A 12/1960 Fester
2,998,795 A 9/1961 Downie et al.
3,099,240 A 7/1963 Montague, Jr.
3,114,343 A 12/1963 Headrick et al.
3,139,853 A 7/1964 McCarthy et al.
3,211,119 A 10/1965 Kiekhaefer
3,270,101 A 8/1966 Jardine et al.
3,343,512 A 9/1967 Rasmussen
3,433,195 A 3/1969 Poole
3,765,356 A 10/1973 Cook
3,964,417 A 6/1976 Williams et al.
4,034,696 A 7/1977 Kureth
4,040,373 A 8/1977 Jones, Jr.
4,205,618 A 6/1980 Olsson
4,304,557 A 12/1981 Henrich
4,323,355 A 4/1982 Kondo
4,352,666 A 10/1982 McGowan

Primary Examiner—Holly H. Baynham
Assistant Examiner—Cynthia M Chin
(74) *Attorney, Agent, or Firm*—McAfee & Taft

(57) **CLAIM**

The ornamental design for a boat stabilizer, as shown.

DESCRIPTION

FIG. 1 is a perspective view of the boat stabilizer, showing our new design;

FIG. 2 is a top plan view thereof;

FIG. 3 is a bottom plan view thereof;

FIG. 4 is a right side elevational view thereof;

FIG. 5 is a left side elevational view thereof;

FIG. 6 is a rear elevational view thereof; and,

FIG. 7 is a front elevational view thereof.

1 Claim, 3 Drawing Sheets

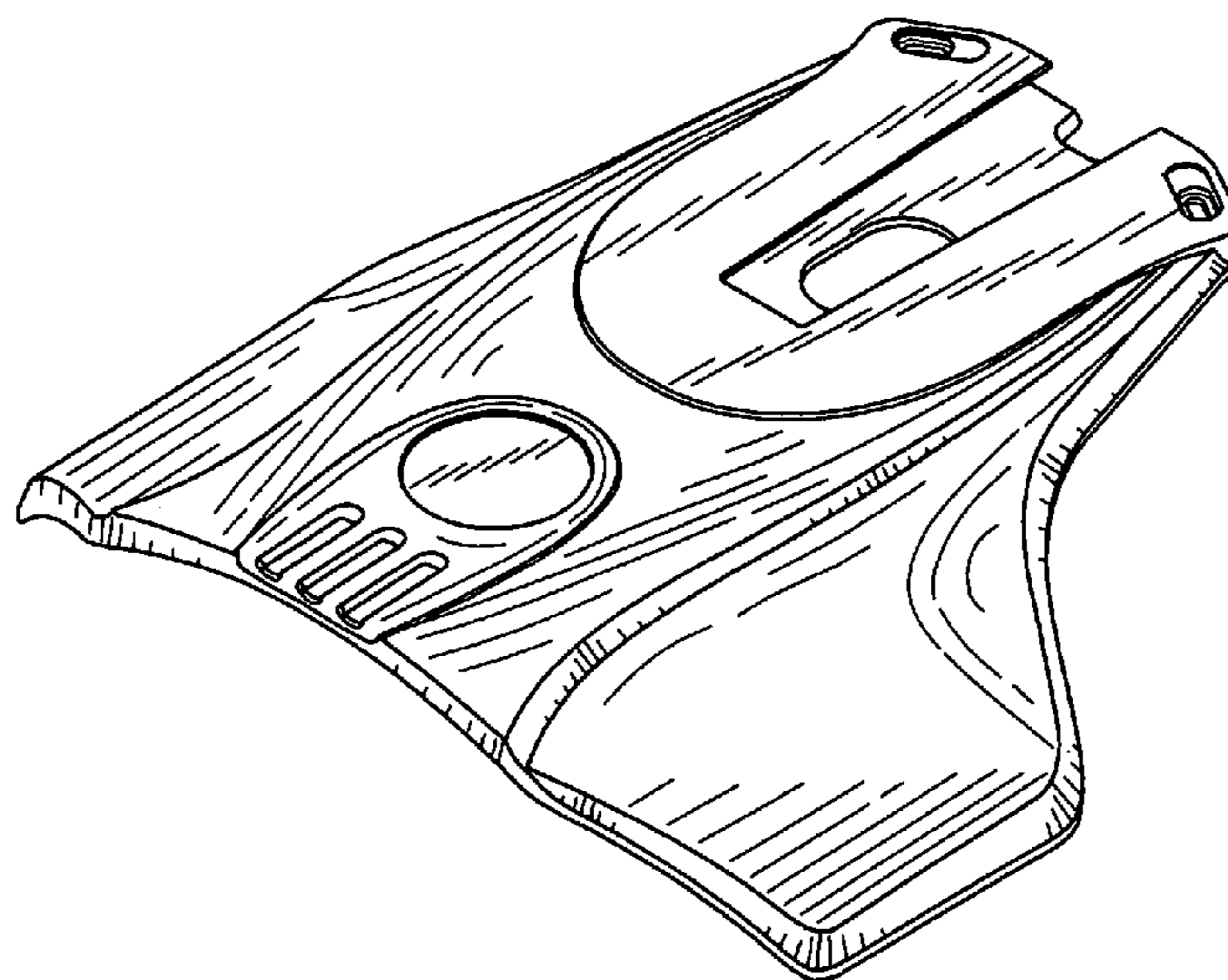

U.S. PATENT DOCUMENTS

4,750,448	A	6/1988	Hennebutte	
4,756,265	A	7/1988	Lane	
D308,851	S *	6/1990	Templeman D12/317
D311,513	S *	10/1990	Templeman D12/317
4,967,682	A	11/1990	O'Donnell	
4,968,275	A	11/1990	Carlson	
4,977,847	A	12/1990	Bartlett	
5,048,449	A *	9/1991	Templeman 114/280
5,105,756	A	4/1992	Bell	
5,107,786	A *	4/1992	Templeman 114/280
D331,738	S *	12/1992	Simpson D12/317
5,203,275	A	4/1993	Brauner et al.	
5,231,950	A	8/1993	Poulos	
D351,129	S *	10/1994	Templeman D12/317
D352,023	S	11/1994	Corn	
D363,914	S *	11/1995	Corn D12/317
5,819,678	A	10/1998	Austin	
5,839,386	A	11/1998	Frieling et al.	
6,659,032	B1	12/2003	Simon	
6,928,949	B1	8/2005	Simon	
6,973,847	B2	12/2005	Adams et al.	
7,004,101	B1	2/2006	Mardikian	
7,115,007	B2	10/2006	Dulger	

FOREIGN PATENT DOCUMENTS

SE 226596 5/1969

OTHER PUBLICATIONS

Author unknown, "Stingray Hydrofoil Stabilizer," dated 1988, 4 total pages, Marine Dynamics, Inc., Overland Park, Kansas.

Author unknown, "Doel-Fin™ Boat Stabilizer," dated 1985, 2 pages, Doechler Products, Inc., Mission Hills, CA.

Author unknown, "Boat Handling/Gas Saving Breakthrough" (regarding the Doel-Fin Boat Stabilizer), dated Sep. 1985, 1 page, Doechler Products, Inc., place of publication unknown.

Author unknown, "Sting Ray™ Torque Equalizerz," dated 1988, 1 page, Marine Dynamics, Inc., place of publication unknown.

Author unknown, "Marine Performance Technology Exchange," Mar. 2004, 3 pages, Hydrocomp, Inc., Marine Performance Technology Exchange.

Author unknown, "Somos® 9120 Epoxy Photopolymer" Product Data Sheet, date unknown - admitted prior art, 1 page, DSM Somos®, New Castle, DE, place of publication unknown.

Author unknown, "Cast Urethanes," date unknown - admitted prior art, 1 page, Quickparts, unknown place of publication.

Author unknown, comments posted in 2004 on "Classically Whaler!, Continuous Wave" regarding "hydrofoil stabilizers" 2004, 8 pages, Classically Whaler!, place of publication unknown.

Author unknown, "The Fastest Hydrofoil on Earth! Sting Ray™ Performance System Hydrofoil Stabilizers Torque Equalizers," published at least as early as 2006, 14 pages, Marine Dynamics, Inc., place of publication unknown.

Author unknown, printouts from web site, date unknown - admitted prior art, 10 pages, Sport Marine Technologies, www.sesport.com.

Author unknown, "Propeller Guard Information Center," dated Oct. 3, 2006, 16 pages, Propeller Guard Information Center, www.rbbi.com/pgic/.

* cited by examiner

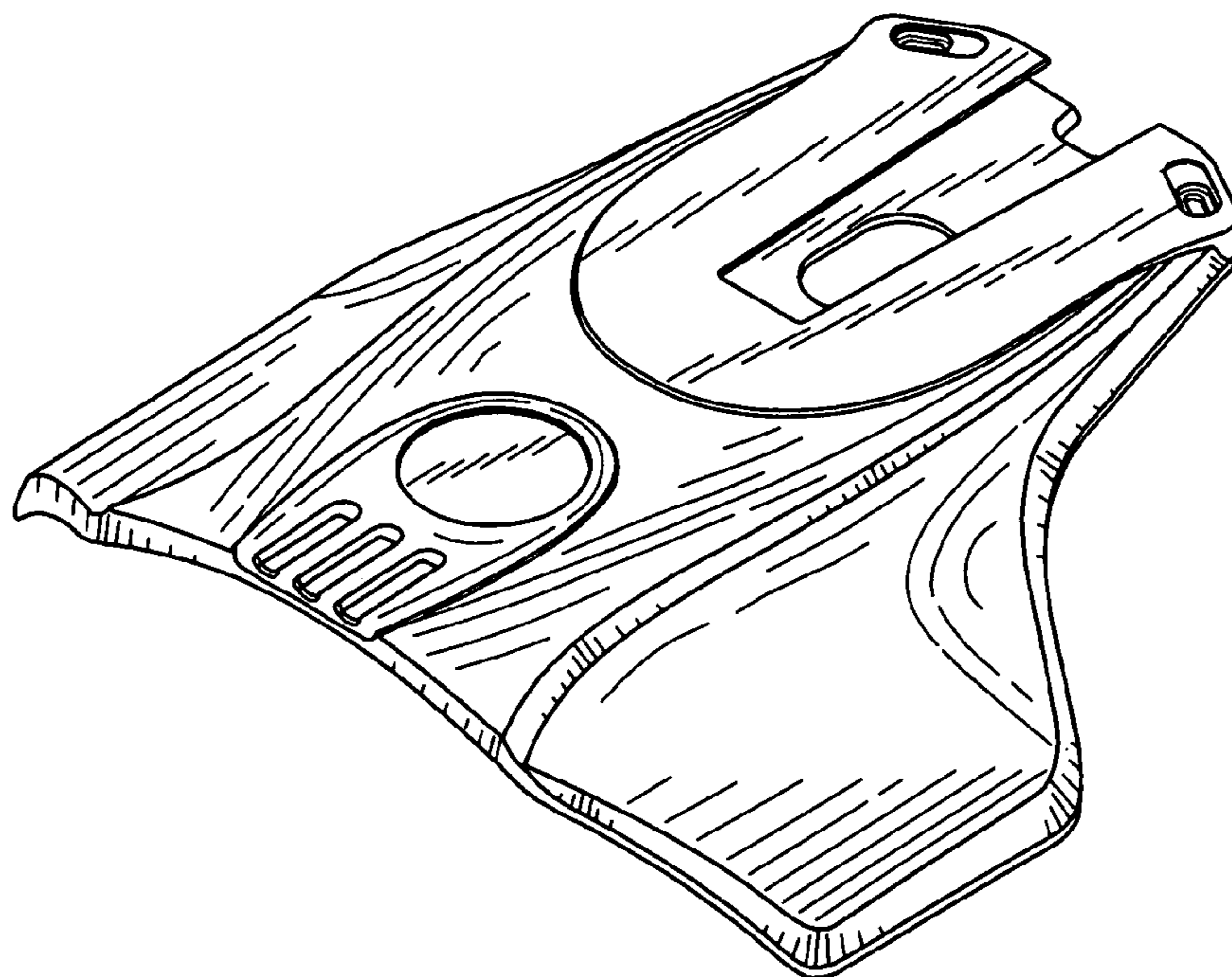

FIG. 1

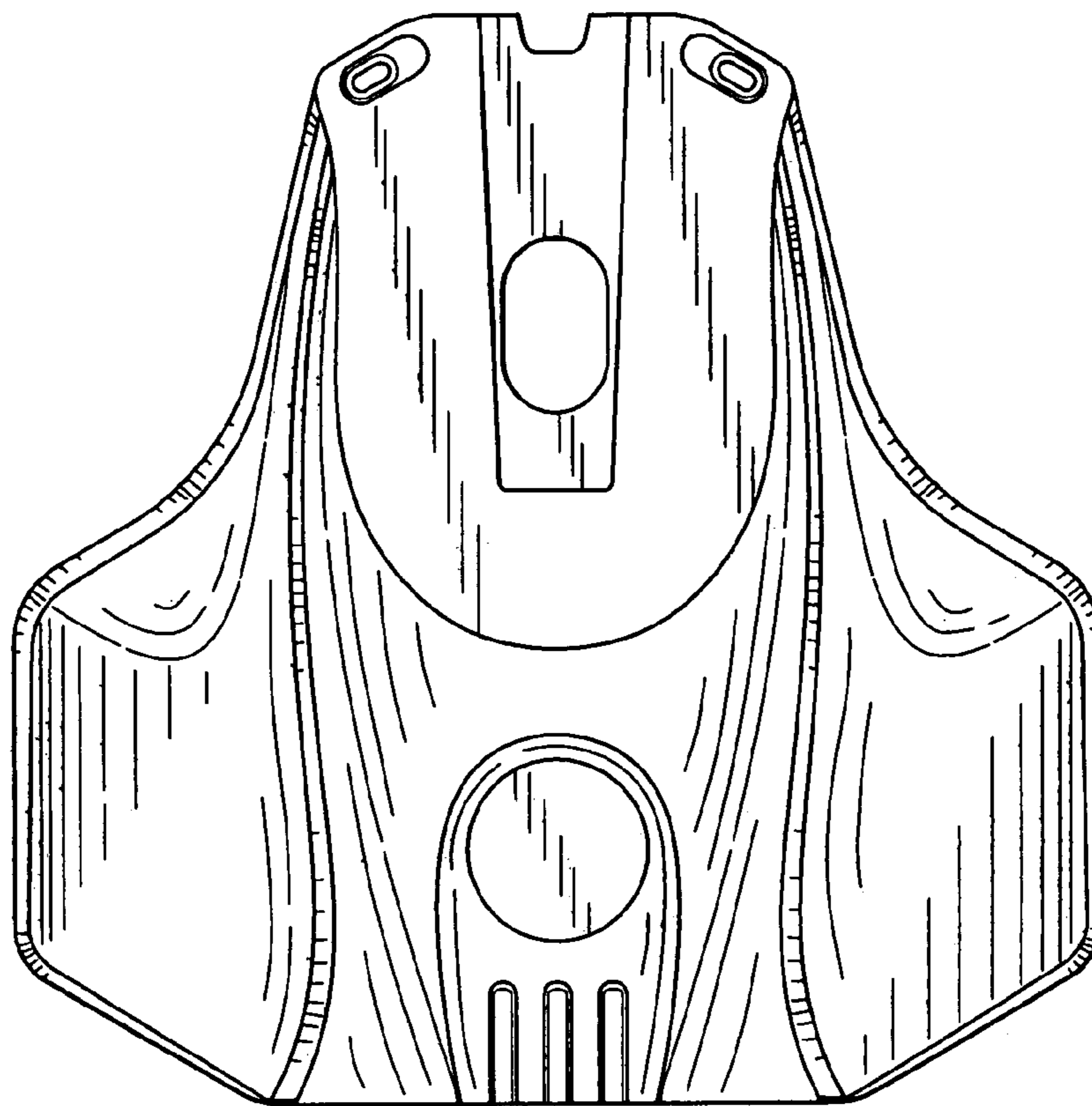

FIG. 2

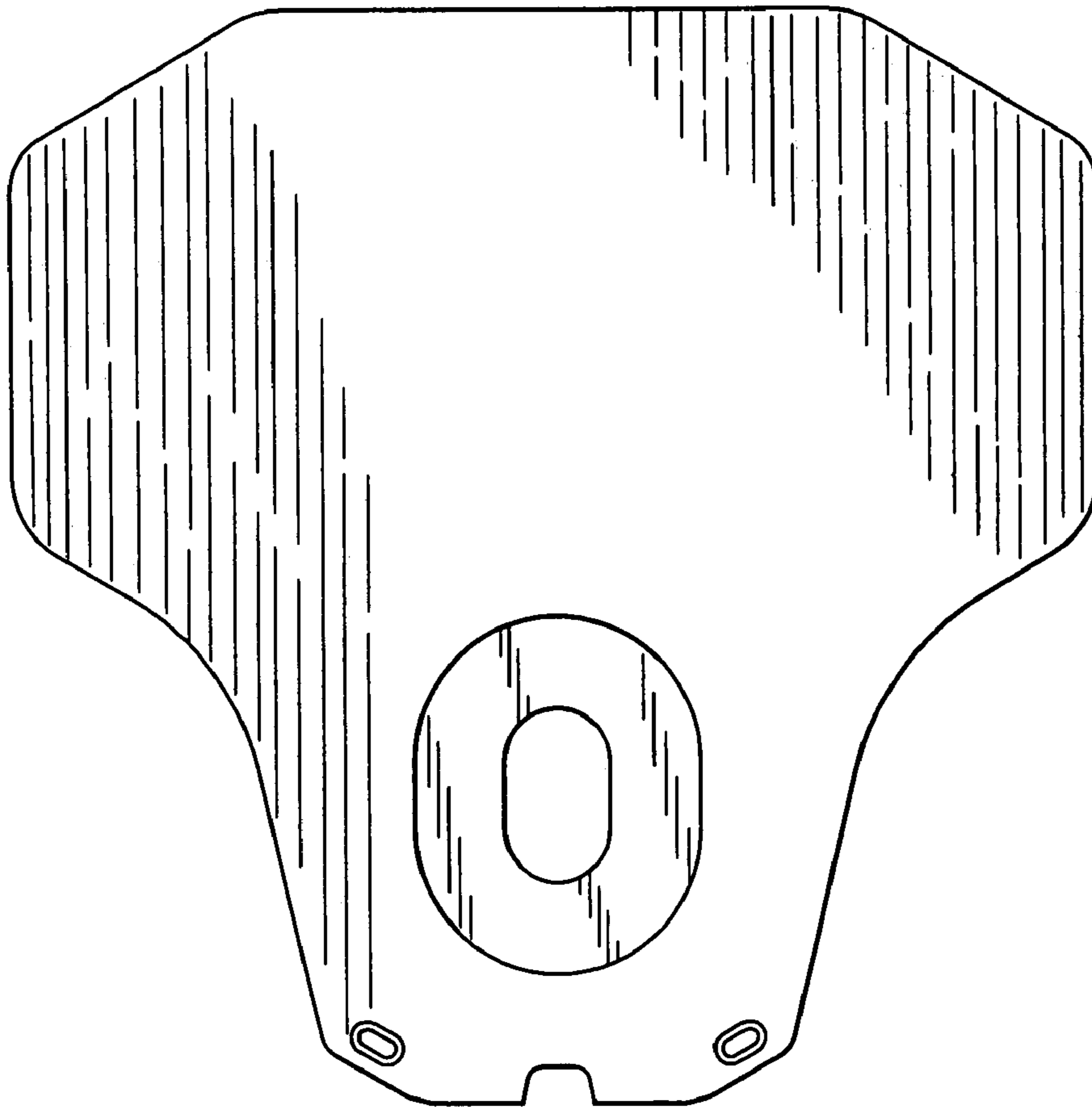

FIG. 3

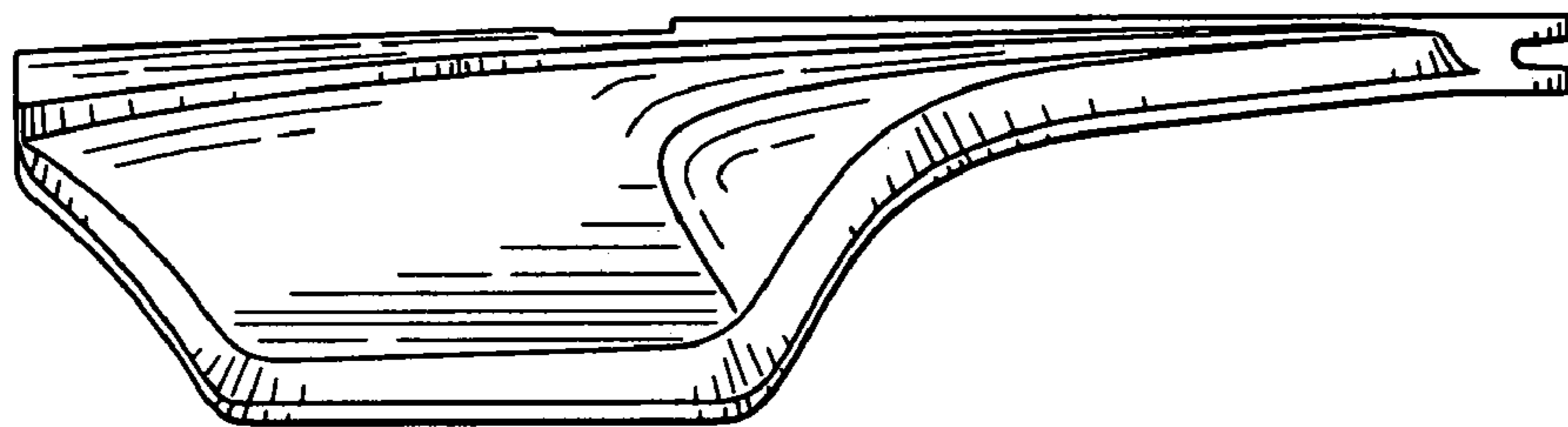

FIG. 4

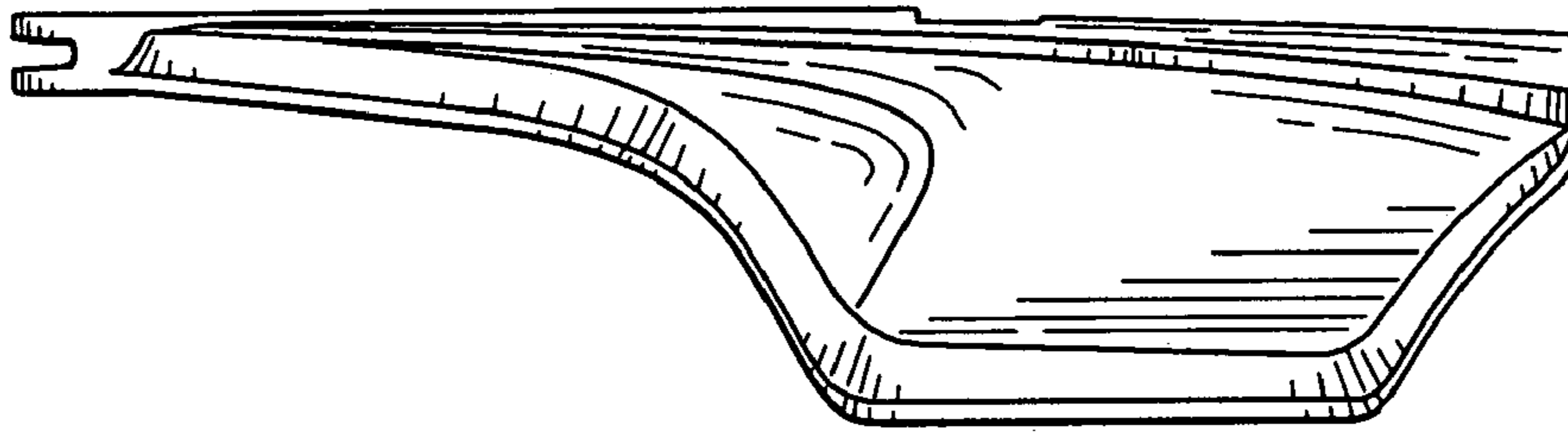

FIG. 1

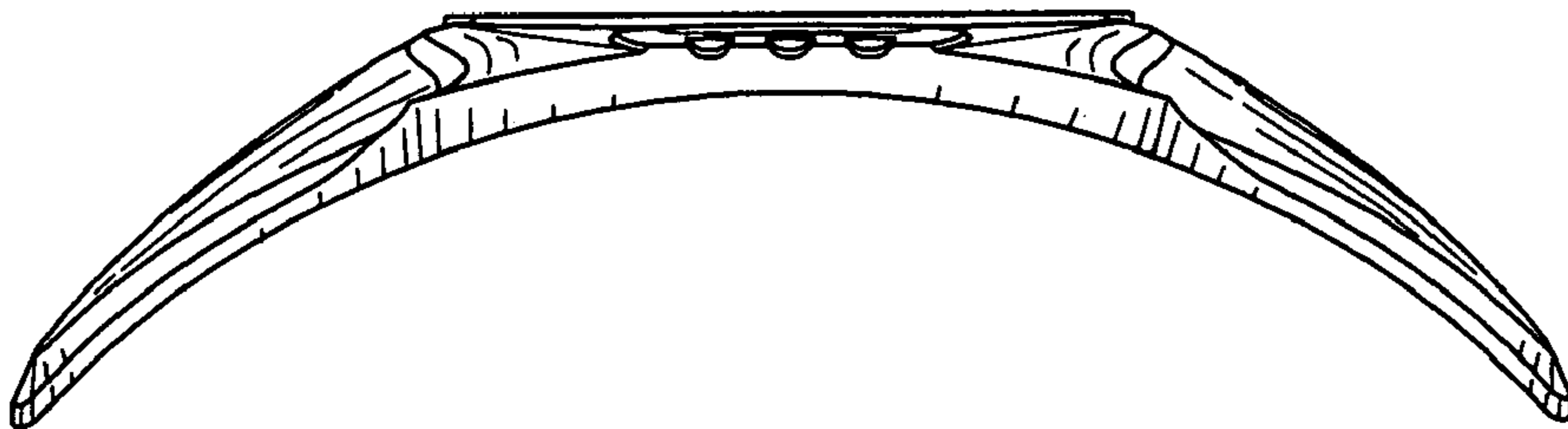

FIG. 2

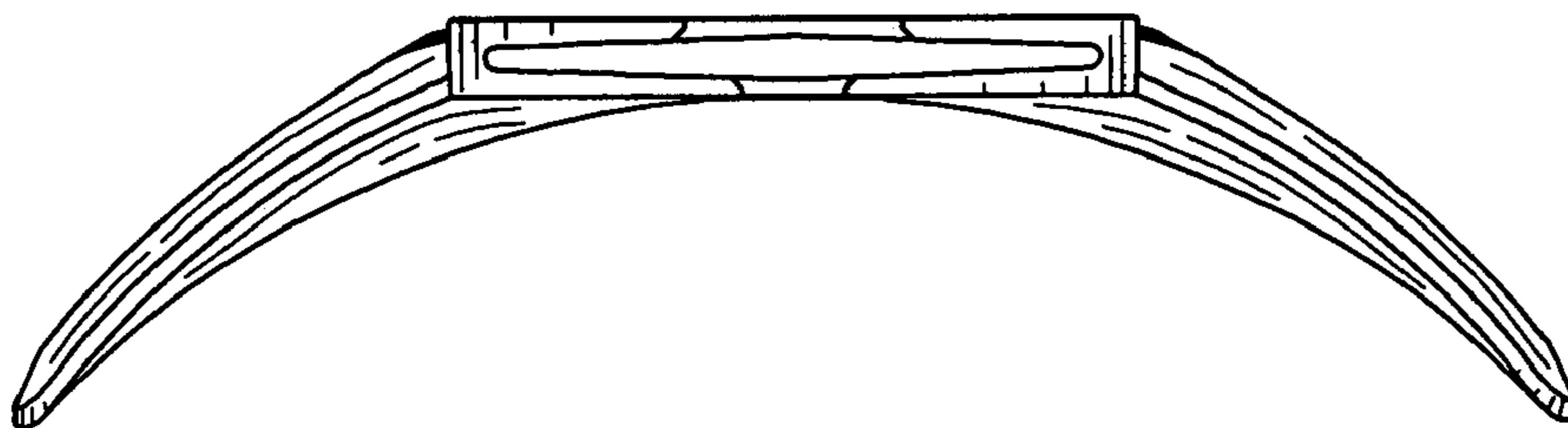

FIG. 3