



US00D589701S

(12) **United States Design Patent**
Christ

(10) **Patent No.:** **US D589,701 S**
(45) **Date of Patent:** **** Apr. 7, 2009**

(54) **POCKET-CONTAINING CLIP STRUCTURE FOR VALUABLES**

(76) Inventor: **George Christ**, 136 Pine St., Garden City, NY (US) 11530

(**) Term: **14 Years**

(21) Appl. No.: **29/306,341**

(22) Filed: **Apr. 8, 2008**

(51) **LOC (9) Cl.** **03-01**

(52) **U.S. Cl.** **D3/247**

(58) **Field of Classification Search** D3/247-252;
150/100, 103-104, 107-110, 114, 118-119
See application file for complete search history.

(56) **References Cited**

U.S. PATENT DOCUMENTS

3,387,641	A	*	6/1968	Osborne	150/132
D253,858	S	*	1/1980	Scheller	D3/243
D290,908	S	*	7/1987	Thomas	D3/274
D564,213	S	*	3/2008	Christ	D3/201

* cited by examiner

Primary Examiner—Holly H Baynham

(74) *Attorney, Agent, or Firm*—Scully, Scott, Murphy & Presser, P.C.

(57) **CLAIM**

The ornamental design for a pocket-containing clip structure for valuables, as shown and described.

DESCRIPTION

FIG. 1 is a front side view of a first embodiment of the pocket-containing clip structure for valuables showing my new and ornamental design with the loop extended therefrom, FIG. 2 is a rear side view showing an external pocket and with the loop of FIG. 1 being wrapped thereabout;

FIG. 3 is a right end view thereof;
FIG. 4 is a left end view thereof;
FIG. 5 is a top view thereof;
FIG. 6 is a front side view of a second embodiment of the pocket-containing clip structure for valuables having external pockets on both sides and with a loop extended therefrom, the opposite side being a mirror image thereof;
FIG. 7 is a rear side view showing the loop of FIG. 6 wrapped thereabout, the opposite side being a mirror image thereof;
FIG. 8 is a right end view thereof;
FIG. 9 is a front end view thereof;
FIG. 10 is a top view thereof;
FIG. 11 is a front side view of a third embodiment of the pocket-containing clip structure for valuables showing my new and ornamental design with the loop extended therefrom;
FIG. 12 is a rear side view showing an external pocket and with the loop of FIG. 11 being wrapped thereabout;
FIG. 13 is a right end view thereof;
FIG. 14 is a left end view thereof;
FIG. 15 is a top view thereof;
FIG. 16 is a front side view of a fourth embodiment of the pocket-containing clip structure for valuables having external pockets on both sides and with a loop extended therefrom, the opposite side being a mirror image thereof;
FIG. 17 is a rear side view showing the loop of FIG. 15 wrapped thereabout, the opposite side being a mirror image thereof;
FIG. 18 is a right end view thereof;
FIG. 19 is a left end view thereof; and,
FIG. 20 is a top view thereof.

The broken line showing of a card and dollar signs are included for the purpose of illustrating environment and forms no part of the claimed design.

1 Claim, 4 Drawing Sheets

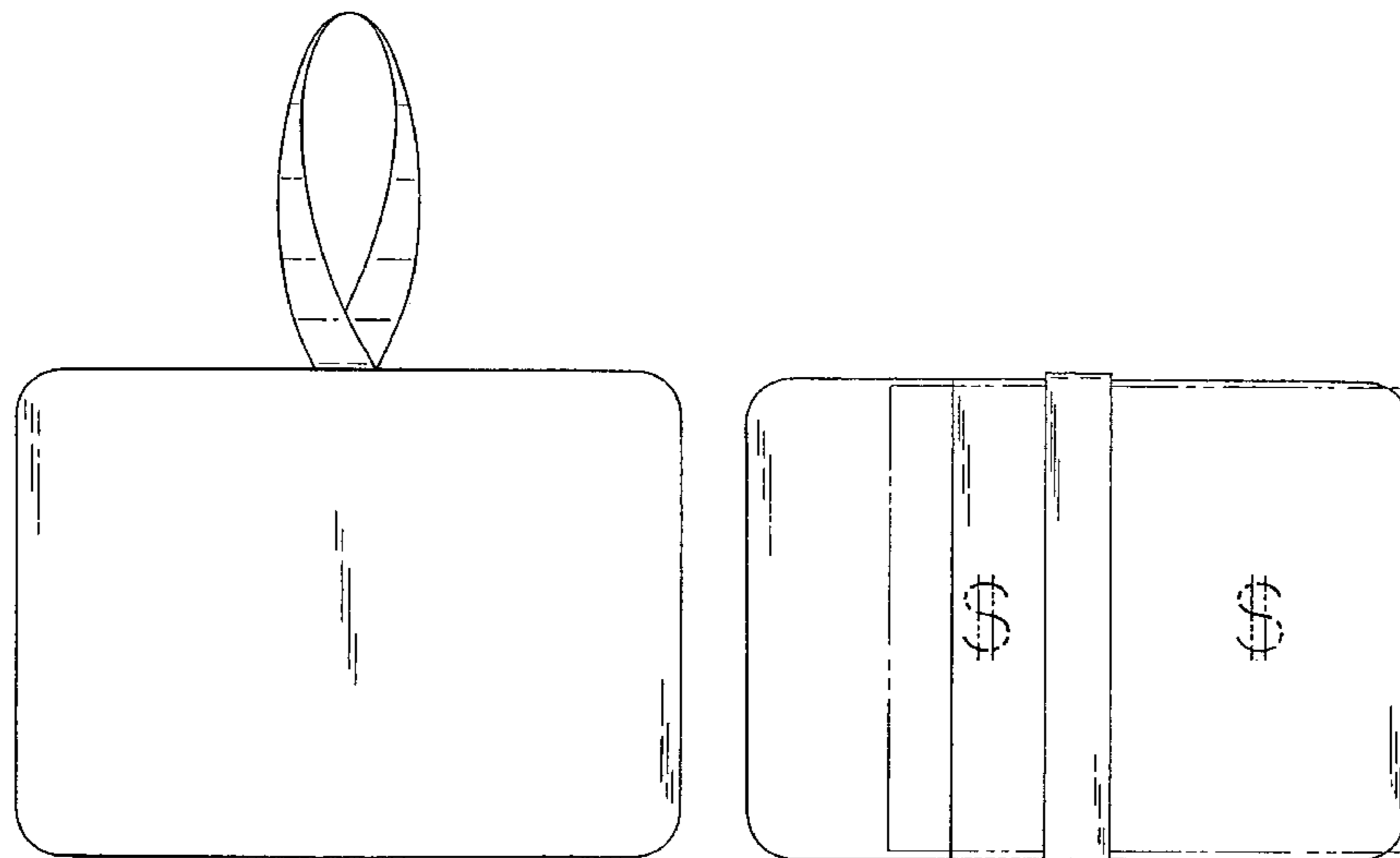

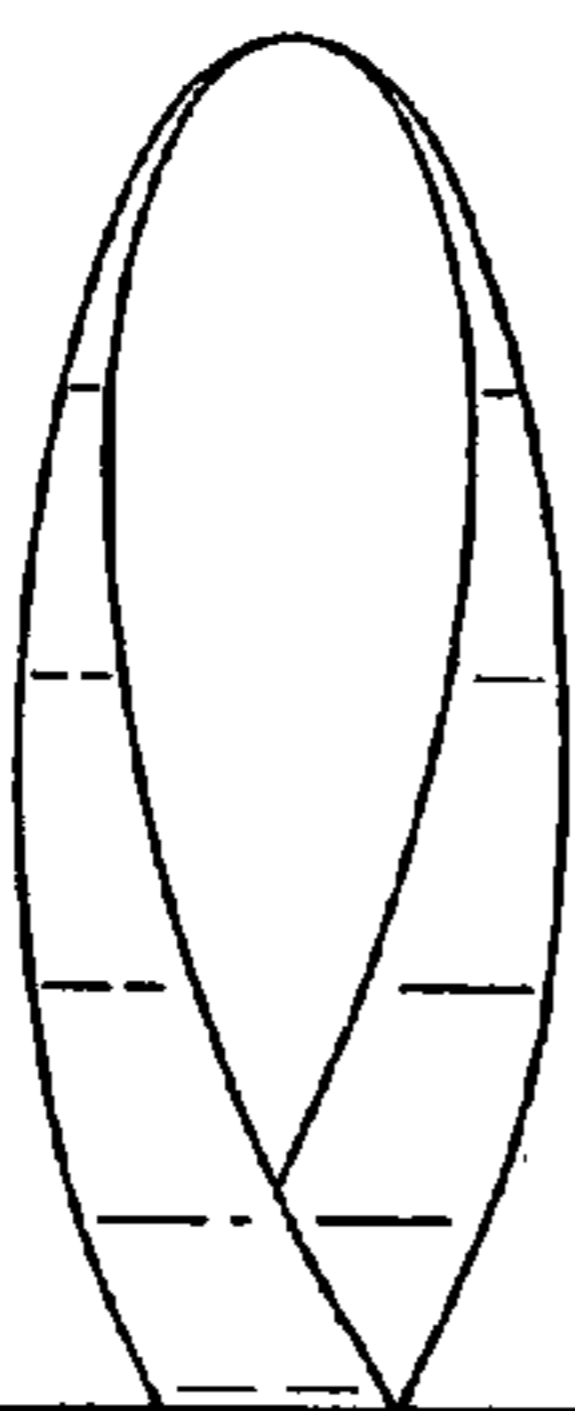
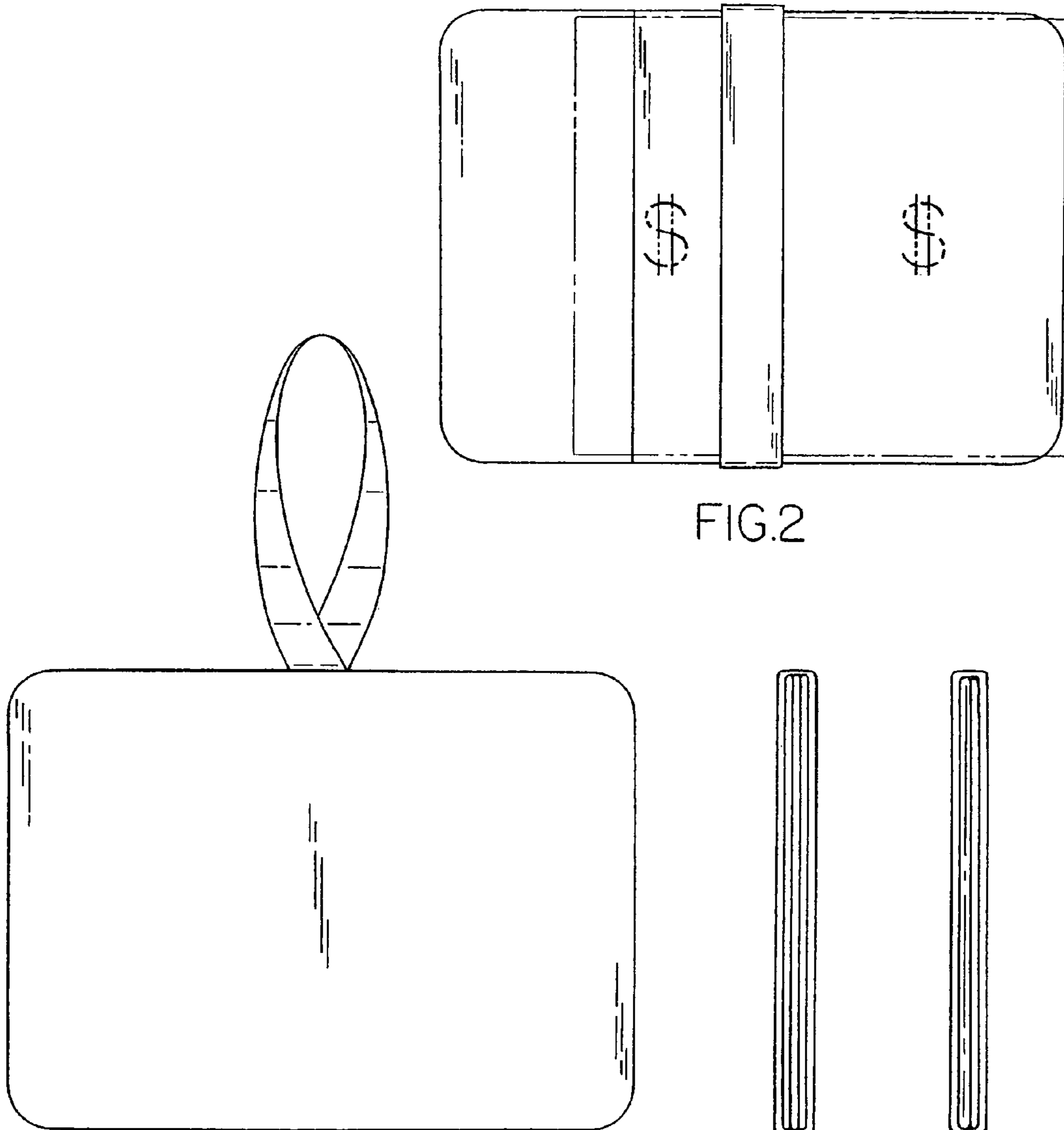

FIG.2

FIG.1

FIG.3

FIG.4

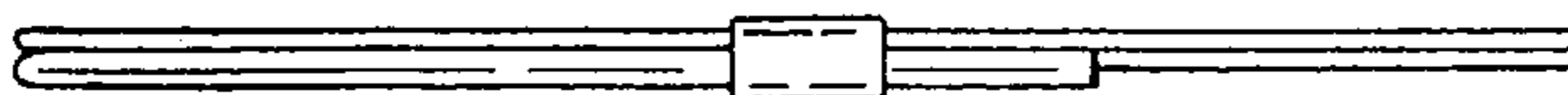

FIG.5

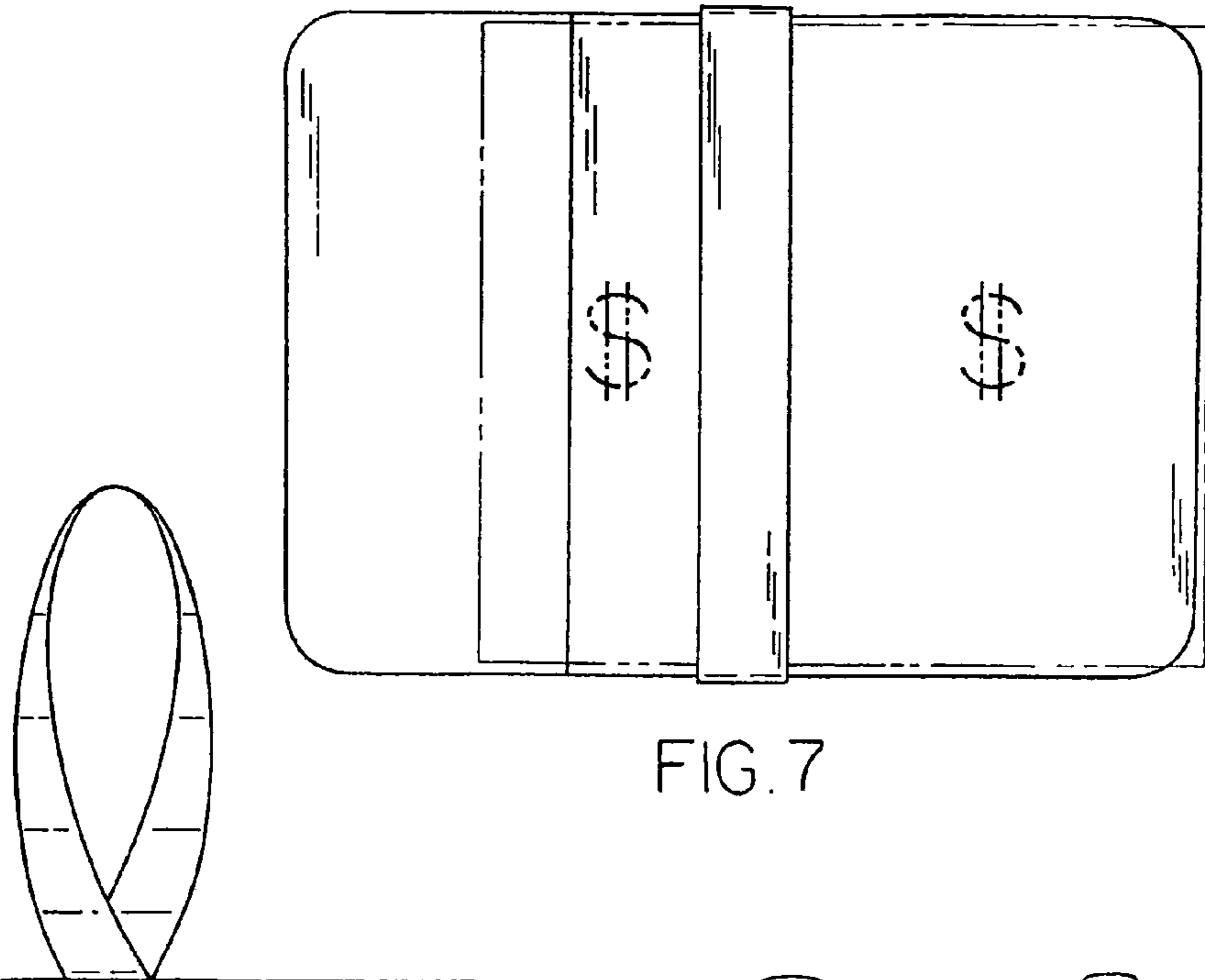

FIG. 7

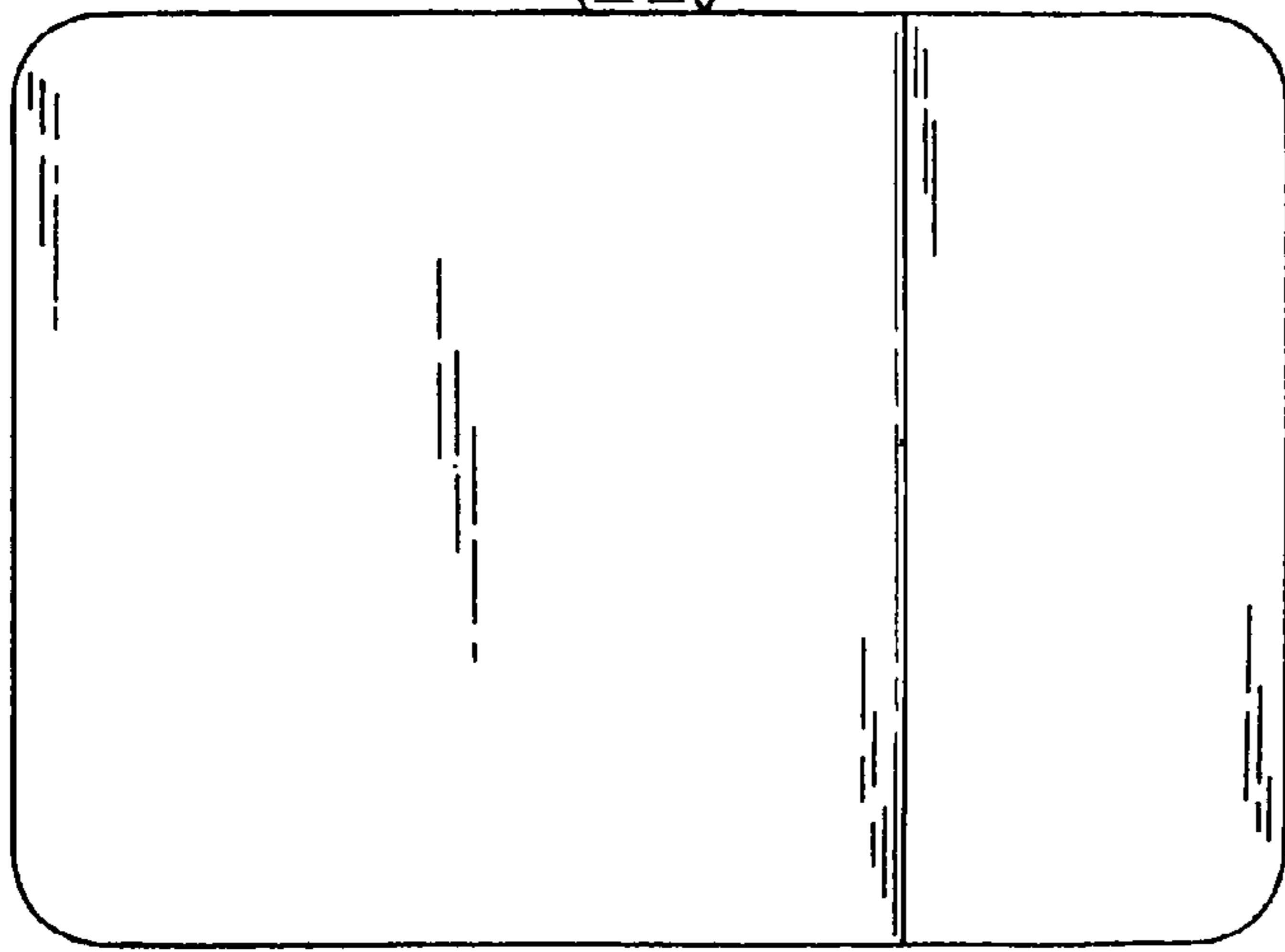

FIG. 6



FIG. 8



FIG. 9

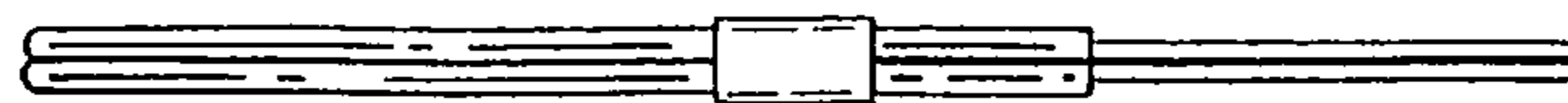

FIG. 10

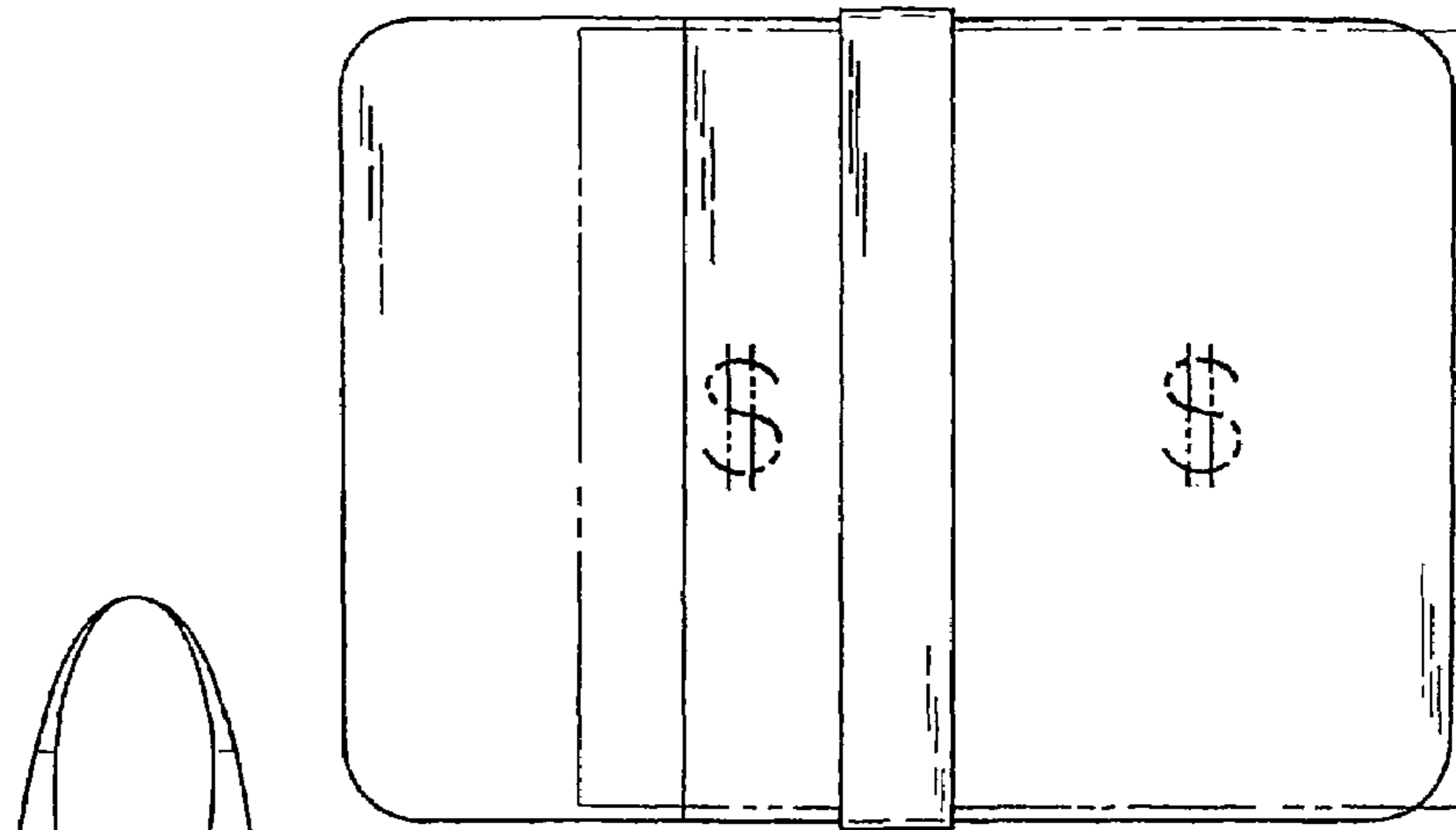

FIG. 12

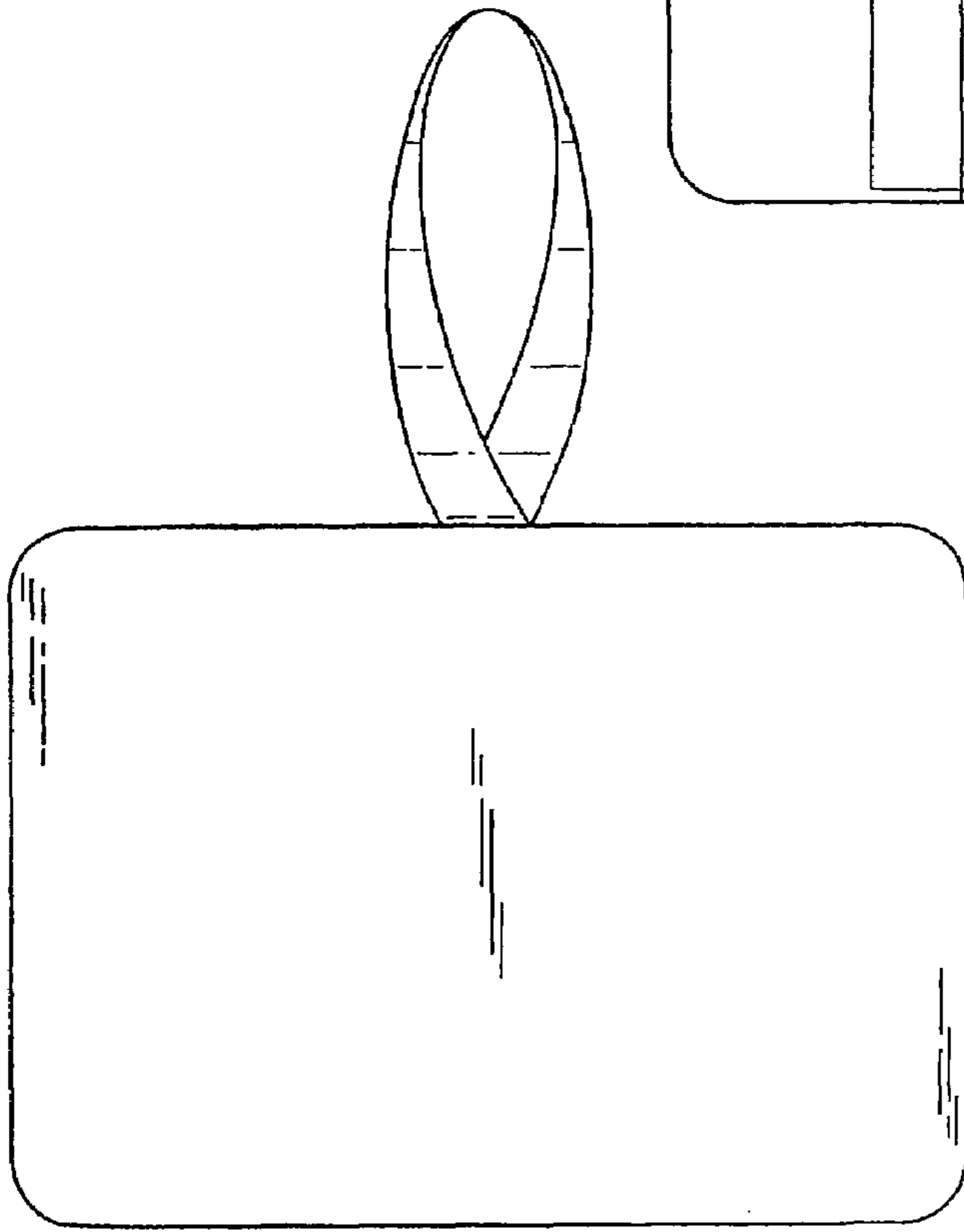

FIG. 11

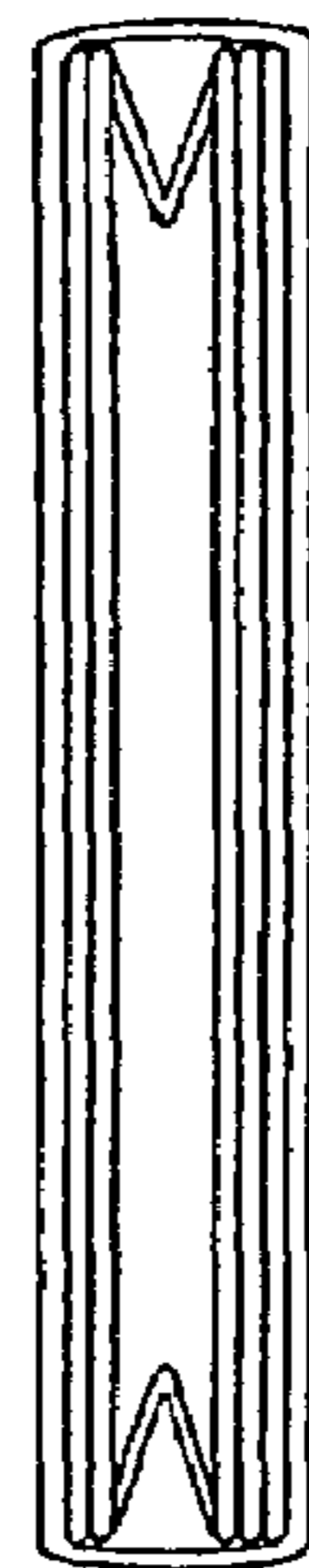

FIG. 13



FIG. 14

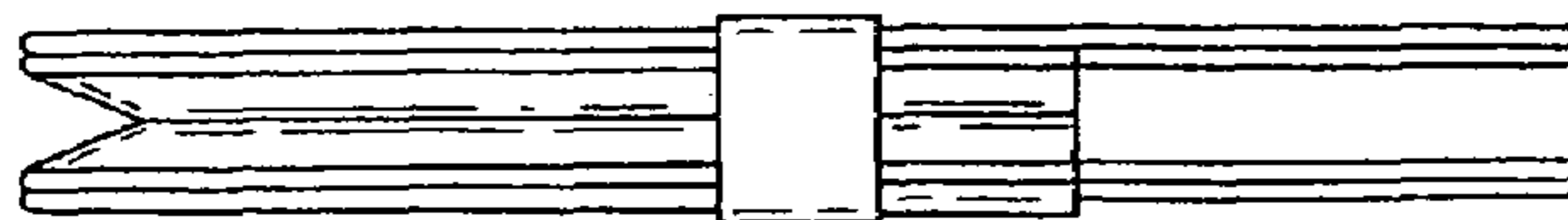

FIG. 15

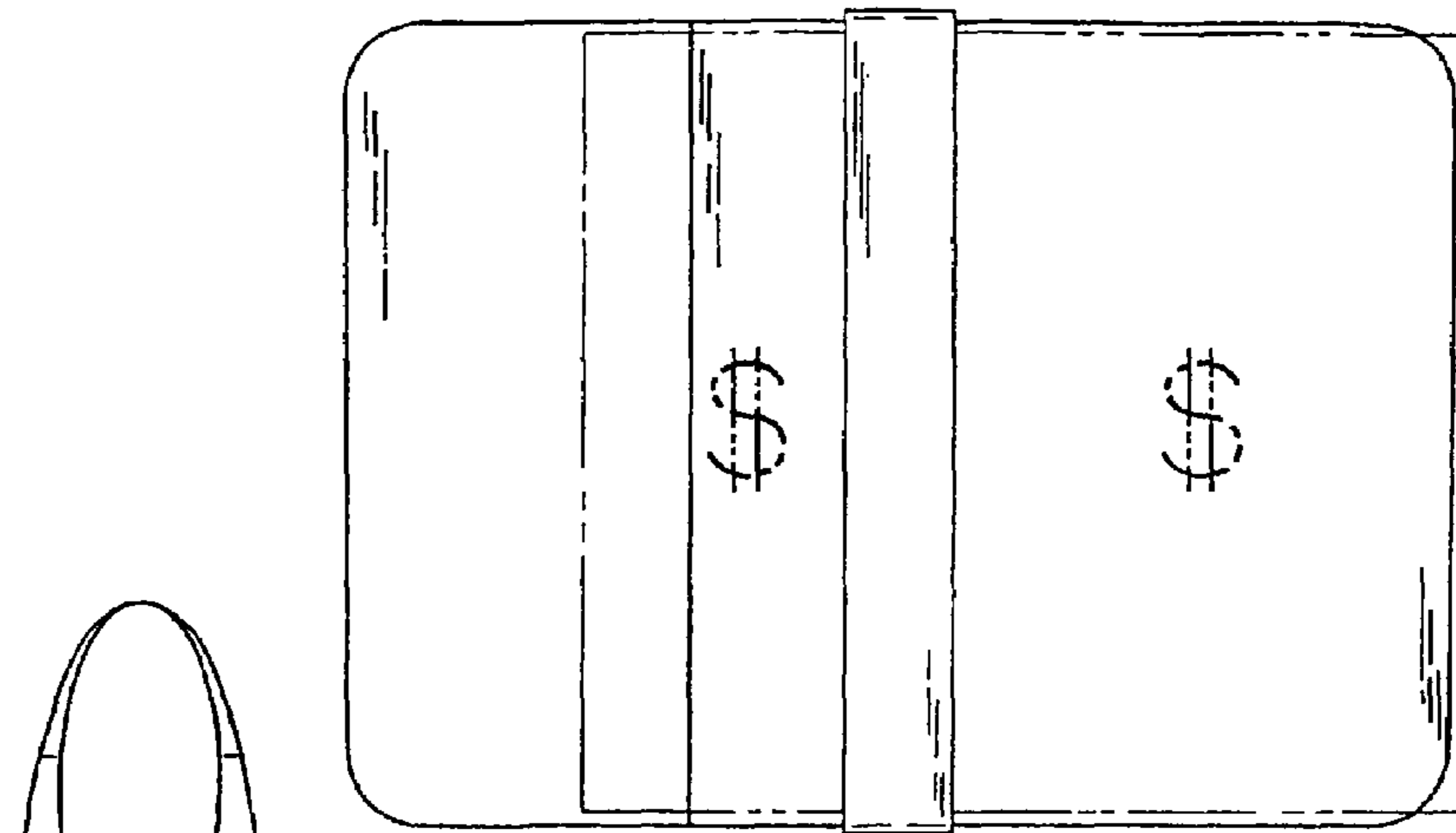

FIG.17

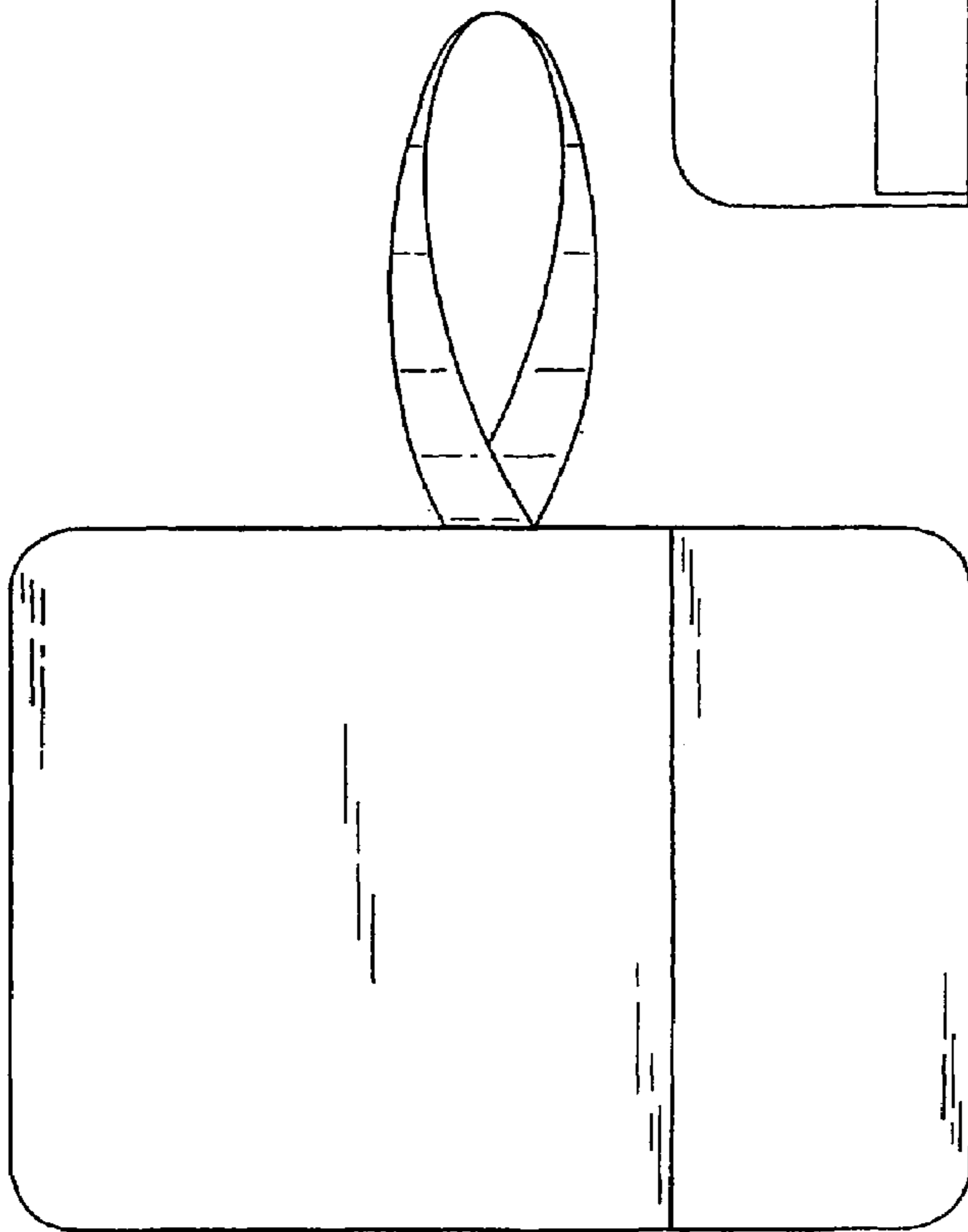

FIG.16



FIG.18



FIG.19

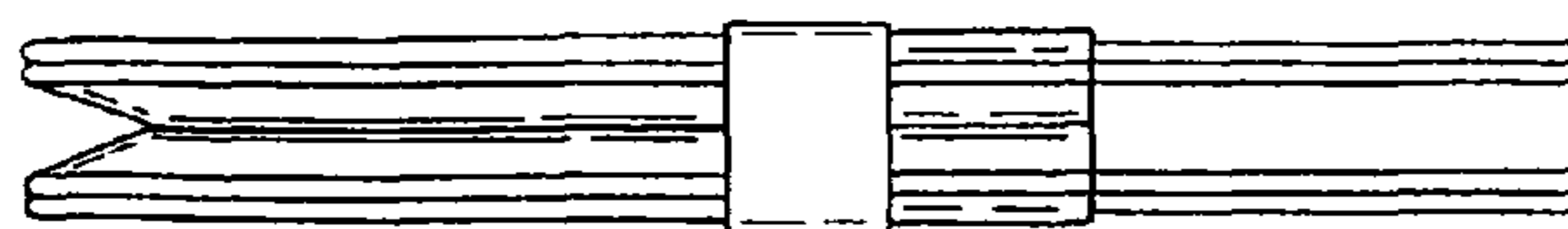

FIG.20