



US00D589615S

(12) **United States Design Patent**  
**Doenges et al.**

(10) **Patent No.:** **US D589,615 S**  
(45) **Date of Patent:** **\*\* Mar. 31, 2009**

(54) **DENTAL FORCEPS**  
(75) Inventors: **Scott Doenges**, West Olive, MI (US);  
**Stacey Buckner**, Whitehall, MI (US)

5,147,368 A \* 9/1992 Brown ..... 606/107  
5,752,960 A \* 5/1998 Nallakrishnan ..... 606/107  
5,813,417 A \* 9/1998 Rudolph ..... 132/200  
D493,889 S \* 8/2004 Koo ..... D24/146

(73) Assignee: **Garrison Dental Solutions**, Spring  
Lake, MI (US)

\* cited by examiner

*Primary Examiner*—Adir Aronovich  
*Assistant Examiner*—Wan Laymon

(\*\*) Term: **14 Years**

(21) Appl. No.: **29/289,593**

(57) **CLAIM**

(22) Filed: **Jul. 25, 2007**

The ornamental design for a dental forceps, as shown and described.

(51) **LOC (9) Cl.** ..... **24-02**

(52) **U.S. Cl.** ..... **D24/146; D24/133; D24/143**

(58) **Field of Classification Search** ..... D24/143,  
D24/149, 152, 146, 154, 133; 606/166–167,  
606/174–175, 205–207, 107, 4–5, 45, 51–52  
See application file for complete search history.

**DESCRIPTION**

FIG. 1 is a perspective view of a dental forceps showing our new design;

FIG. 2 is a first side elevational view thereof;

FIG. 3 is a second side elevational view thereof;

FIG. 4 is a top plan view thereof;

FIG. 5 is a rear elevational view thereof; and,

FIG. 6 is a front elevational view thereof.

(56) **References Cited**

**U.S. PATENT DOCUMENTS**

4,785,810 A \* 11/1988 Baccala et al. .... 606/107  
4,959,070 A \* 9/1990 McDonald ..... 606/107  
5,135,530 A \* 8/1992 Lehmer ..... 606/107

**1 Claim, 5 Drawing Sheets**

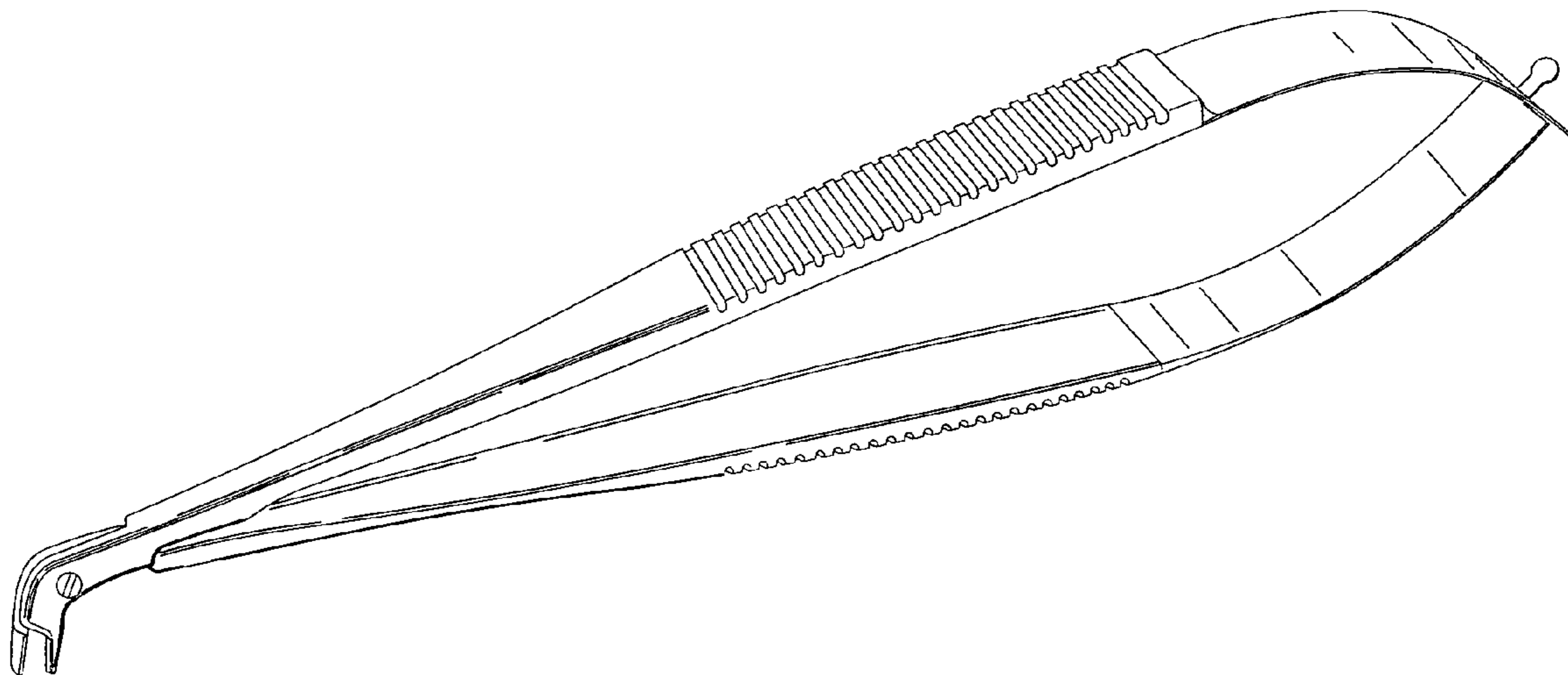

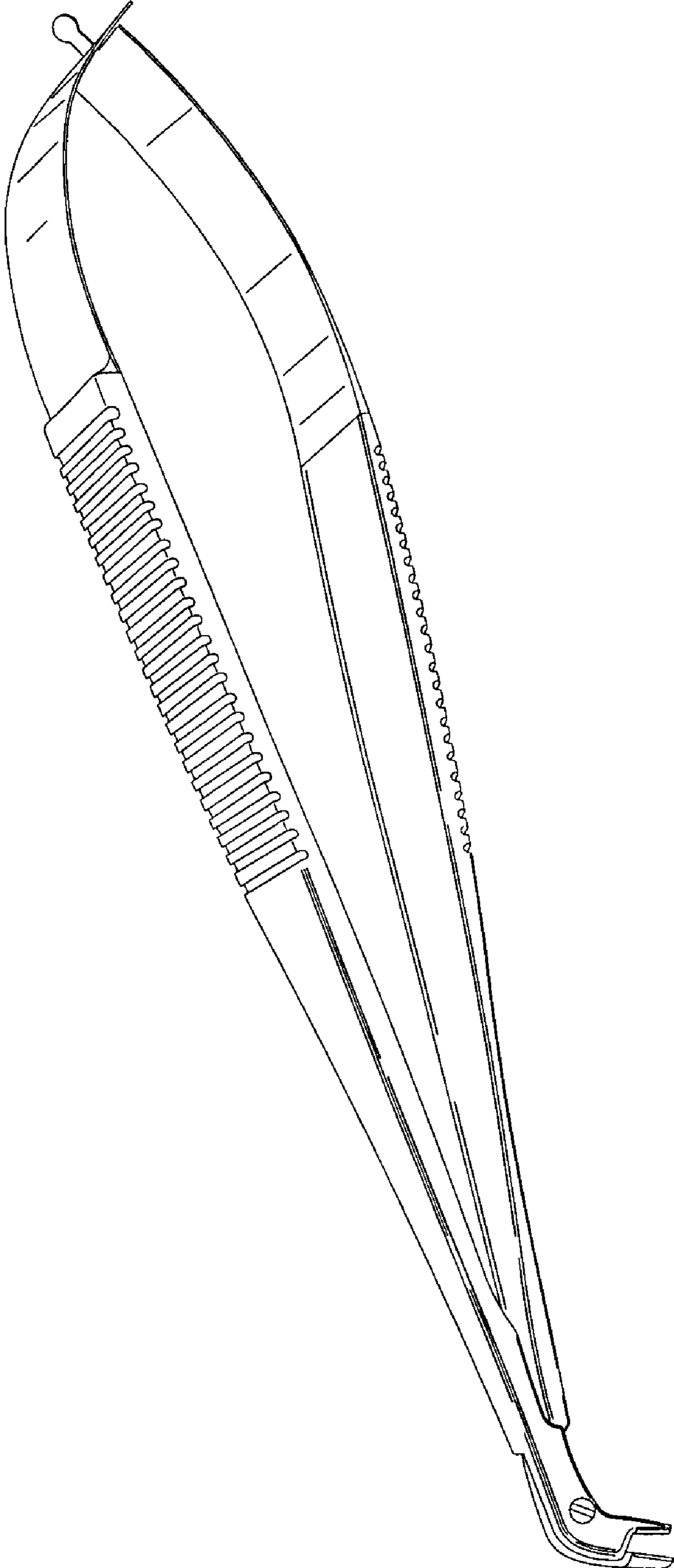
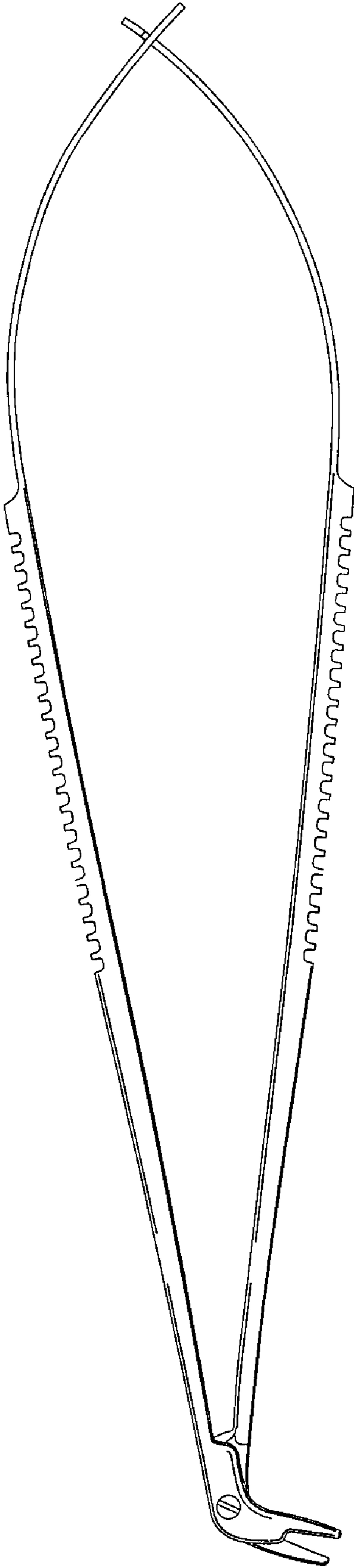
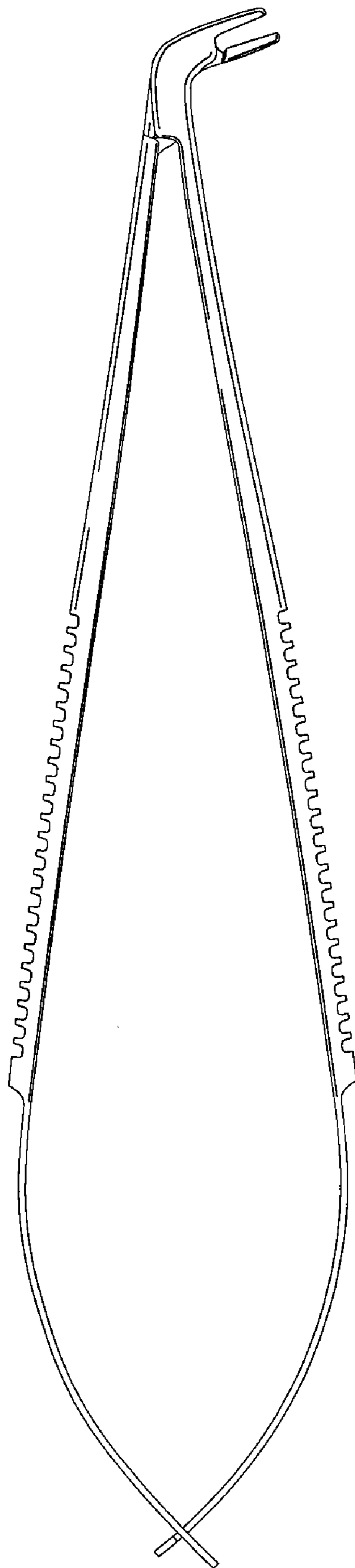

FIG. 1



**FIG. 2**



**FIG. 3**

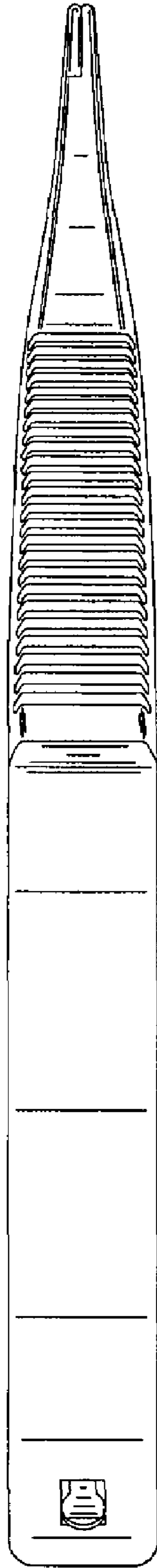

**FIG. 4**

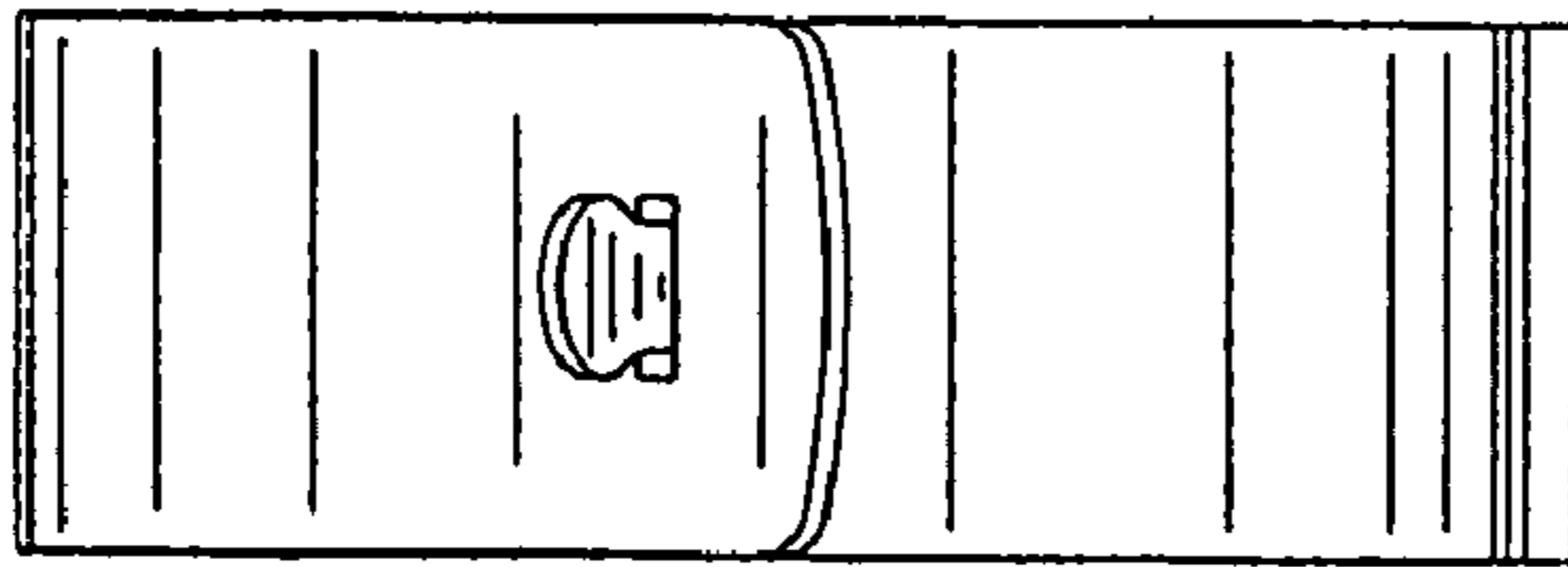

FIG. 5

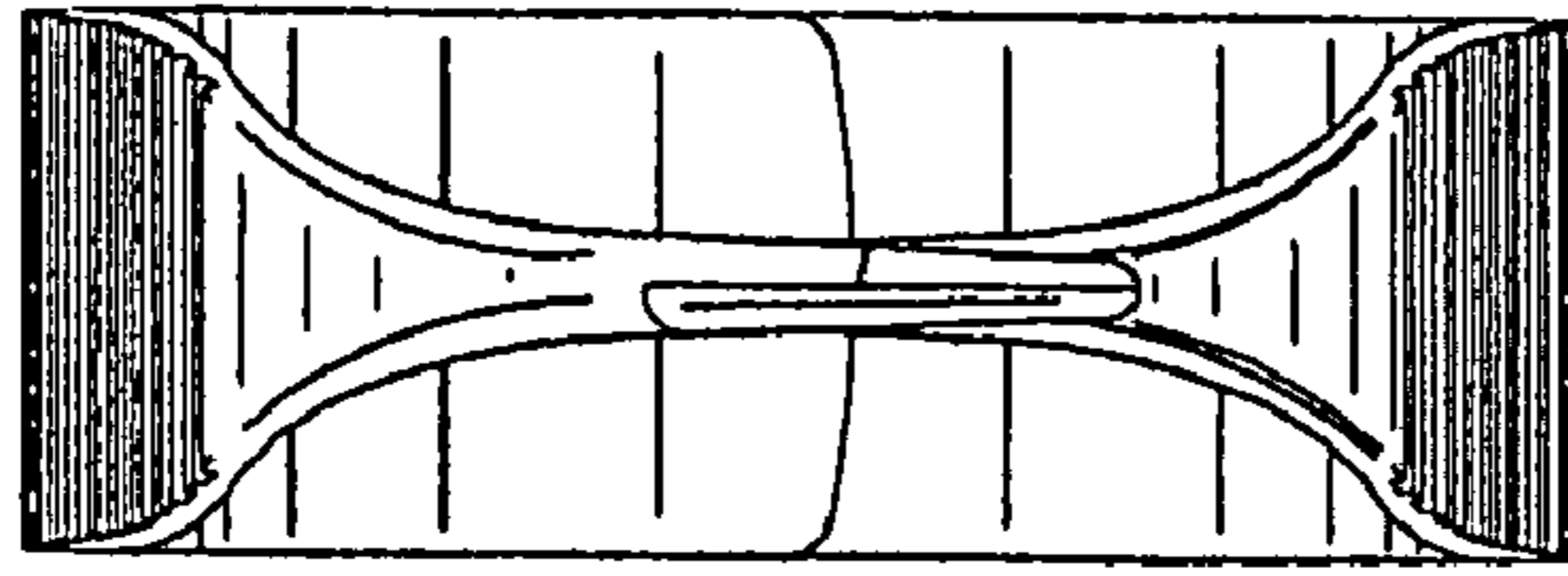

FIG. 6