



US00D589569S

(12) **United States Design Patent**
Sato et al.

(10) **Patent No.:** **US D589,569 S**

(45) **Date of Patent:** **** Mar. 31, 2009**

(54) **TOY**

(75) Inventors: **Wataru Sato**, Kawasaki (JP); **Noriyoshi Matsumura**, Chiba (JP)

(73) Assignee: **Spin Master Ltd.**, Toronto, Ontario (CA)

(**) Term: **14 Years**

(21) Appl. No.: **29/292,039**

(22) Filed: **Sep. 26, 2007**

(51) **LOC (9) Cl.** **21-01**

(52) **U.S. Cl.** **D21/584; D21/606**

(58) **Field of Classification Search** D21/578–584, D21/606; 446/71–72, 97, 99, 487
See application file for complete search history.

(56) **References Cited**

U.S. PATENT DOCUMENTS

D272,458 S	1/1984	Fleminger
D286,800 S	11/1986	Maruyama
D287,258 S	12/1986	Maruyama
D292,110 S	9/1987	Tamakoshi
D296,916 S	7/1988	Matsuda
D297,749 S	9/1988	Rodis-Jamero
D298,150 S	10/1988	Torres et al.
D298,151 S	10/1988	Torres et al.

(74) *Attorney, Agent, or Firm*—Cohen Pontani Lieberman & Pavane LLP

(57) **CLAIM**

The ornamental design for a toy, as shown and described.

DESCRIPTION

FIG. 1 is a front perspective view of the toy in its opened state; FIG. 2 is a rear perspective view of the toy in its opened state; FIG. 3 is a top view of the toy in its opened state; FIG. 4 is a bottom view of the toy in its opened state; FIG. 5 is a front view of the toy in its opened state; FIG. 6 is a rear view of the toy in its opened state; FIG. 7 is a left-side view of the toy in its opened state; FIG. 8 is a right-side view of the toy in its opened state; FIG. 9 is a front perspective view of the toy in its closed state; FIG. 10 is a top view of the toy in its closed state; FIG. 11 is a bottom view of the toy in its closed state; FIG. 12 is a front view of the toy in its closed state; FIG. 13 is a rear view of the toy in its closed state; FIG. 14 is a left-side view of the toy in its closed state; and, FIG. 15 is a right-side view of the toy in its closed state.

The broken line showing is for illustrative purposes only, and forms no part of the claimed design.

Primary Examiner—Sandra Morris

1 Claim, 8 Drawing Sheets

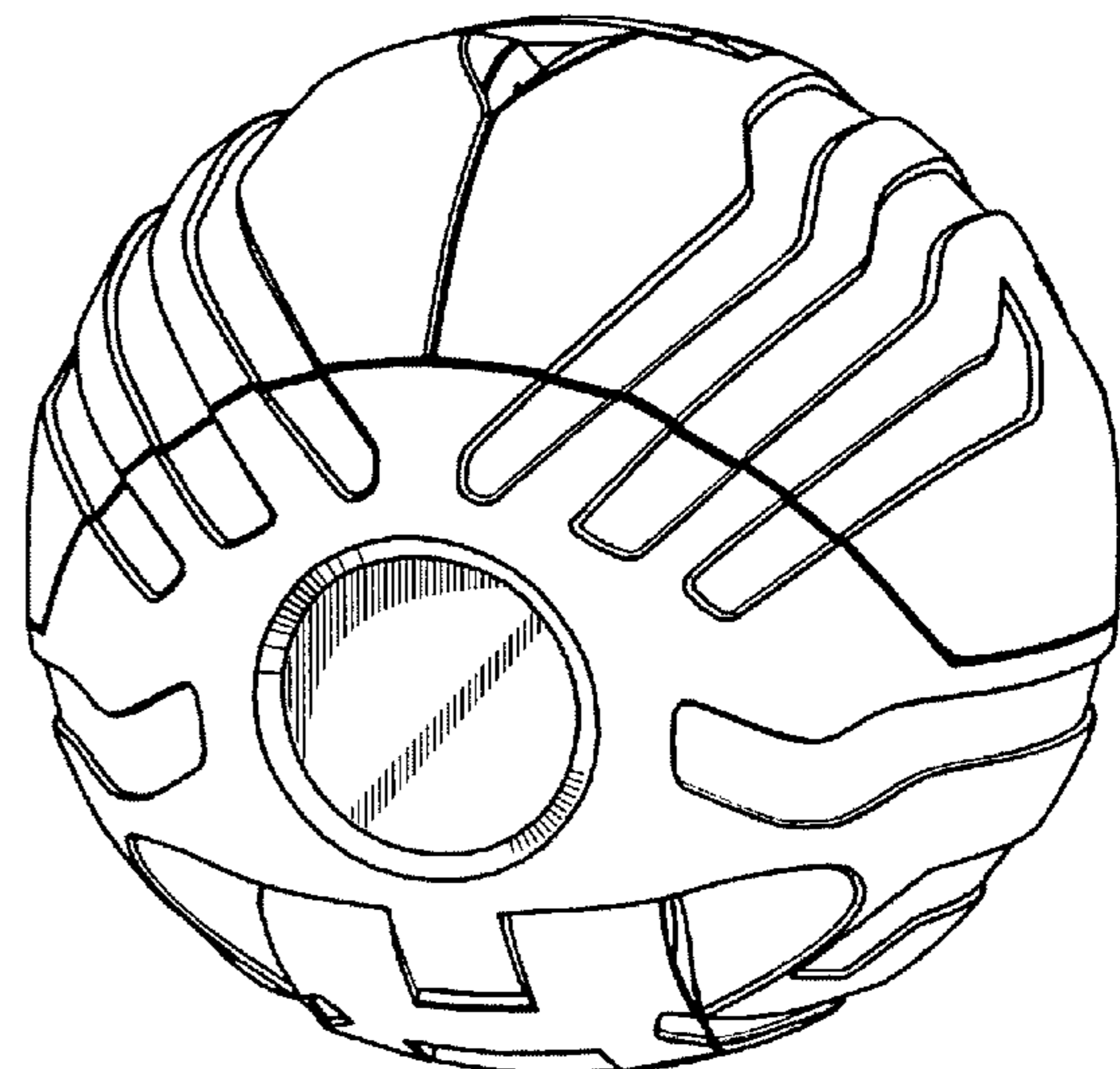
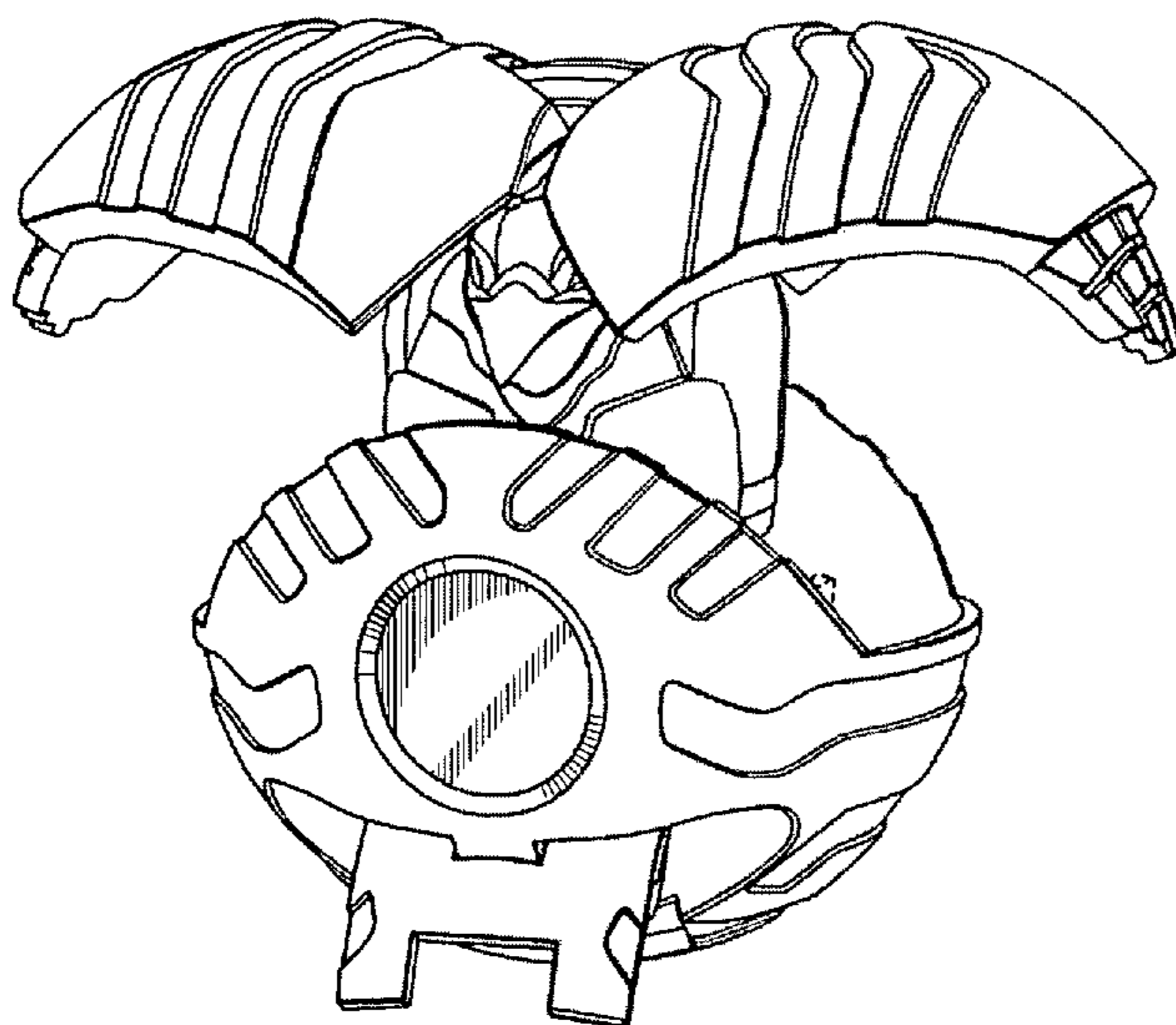

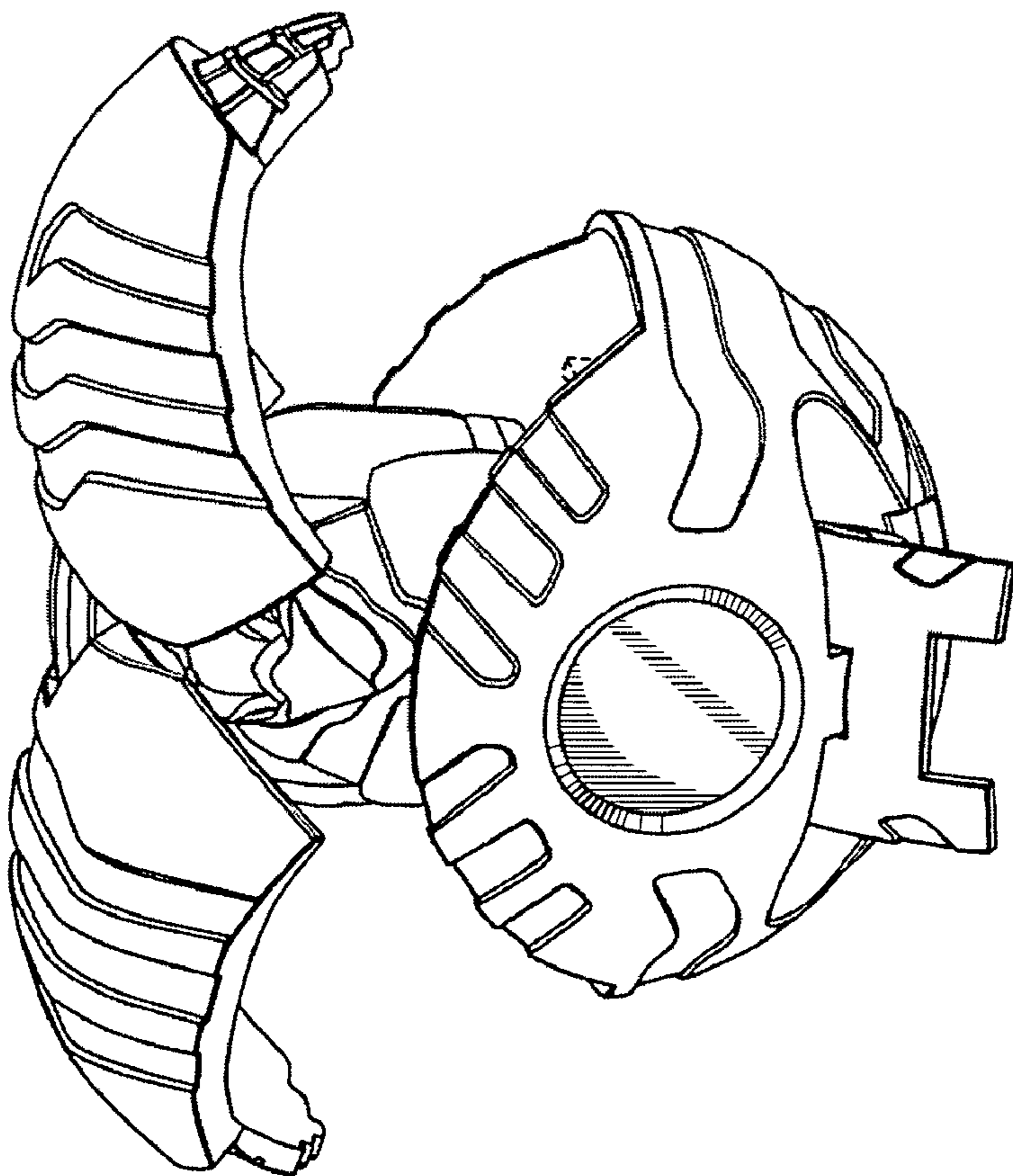

Fig. 1

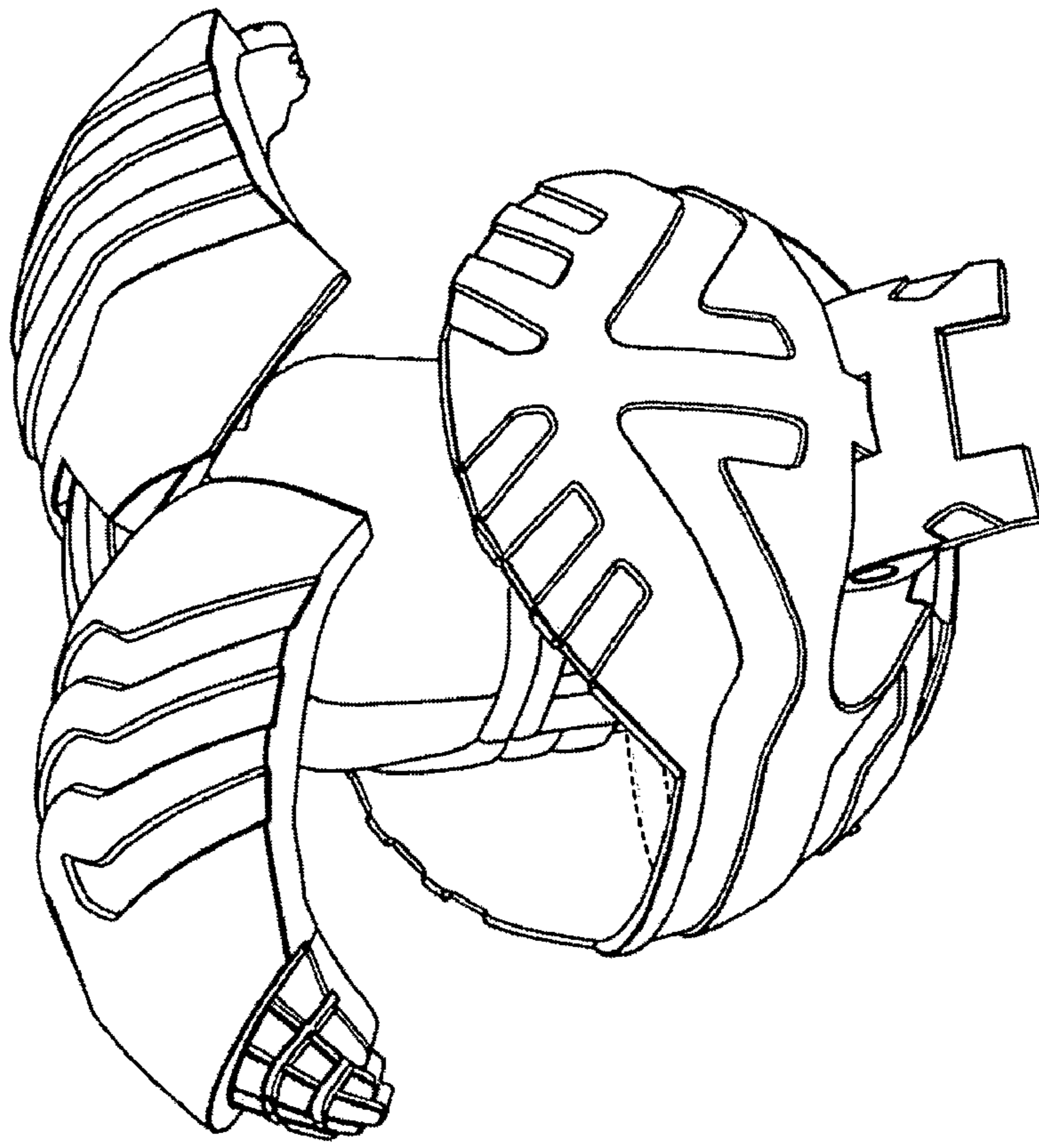

Fig. 2

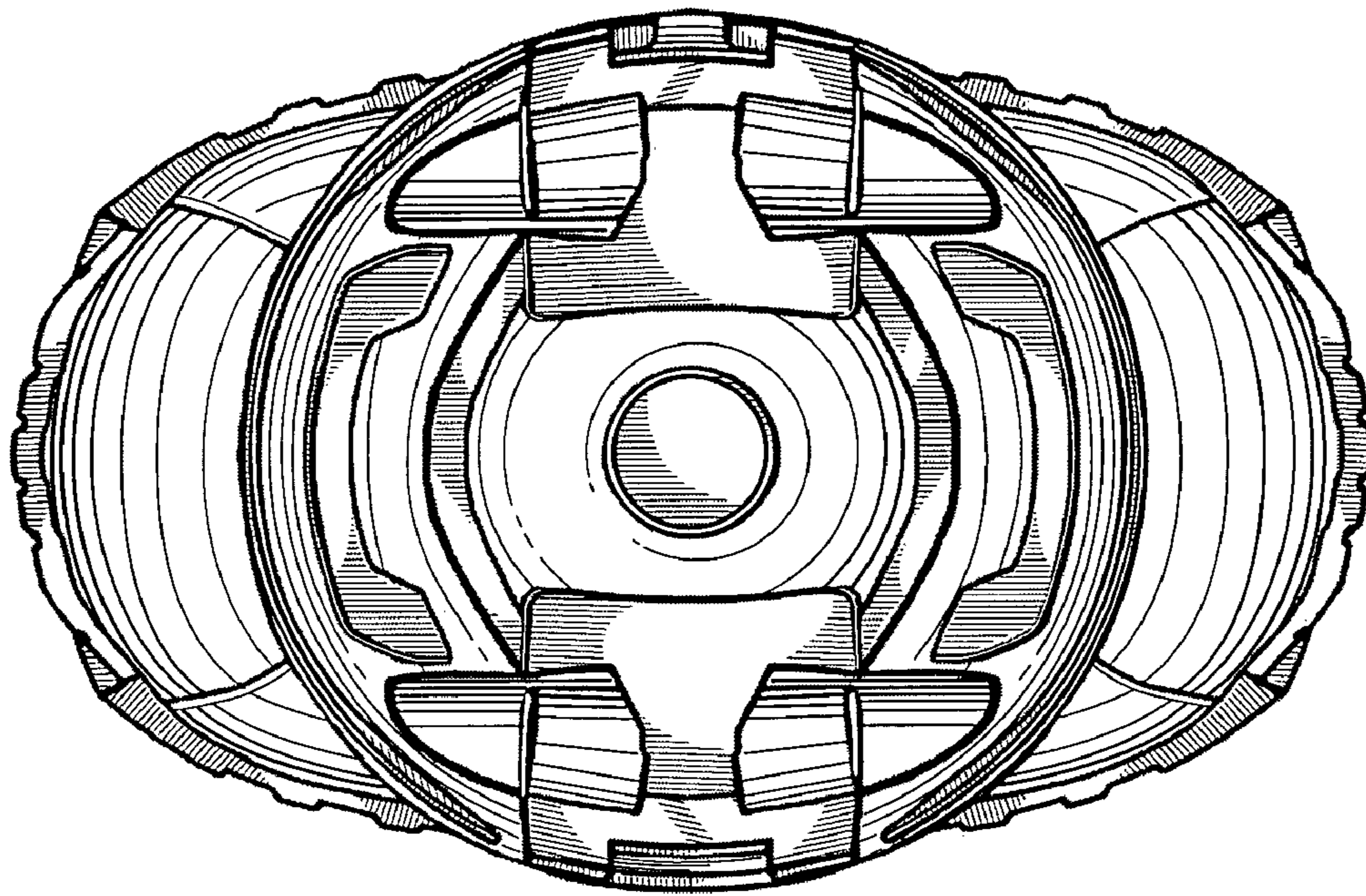

Fig. 4

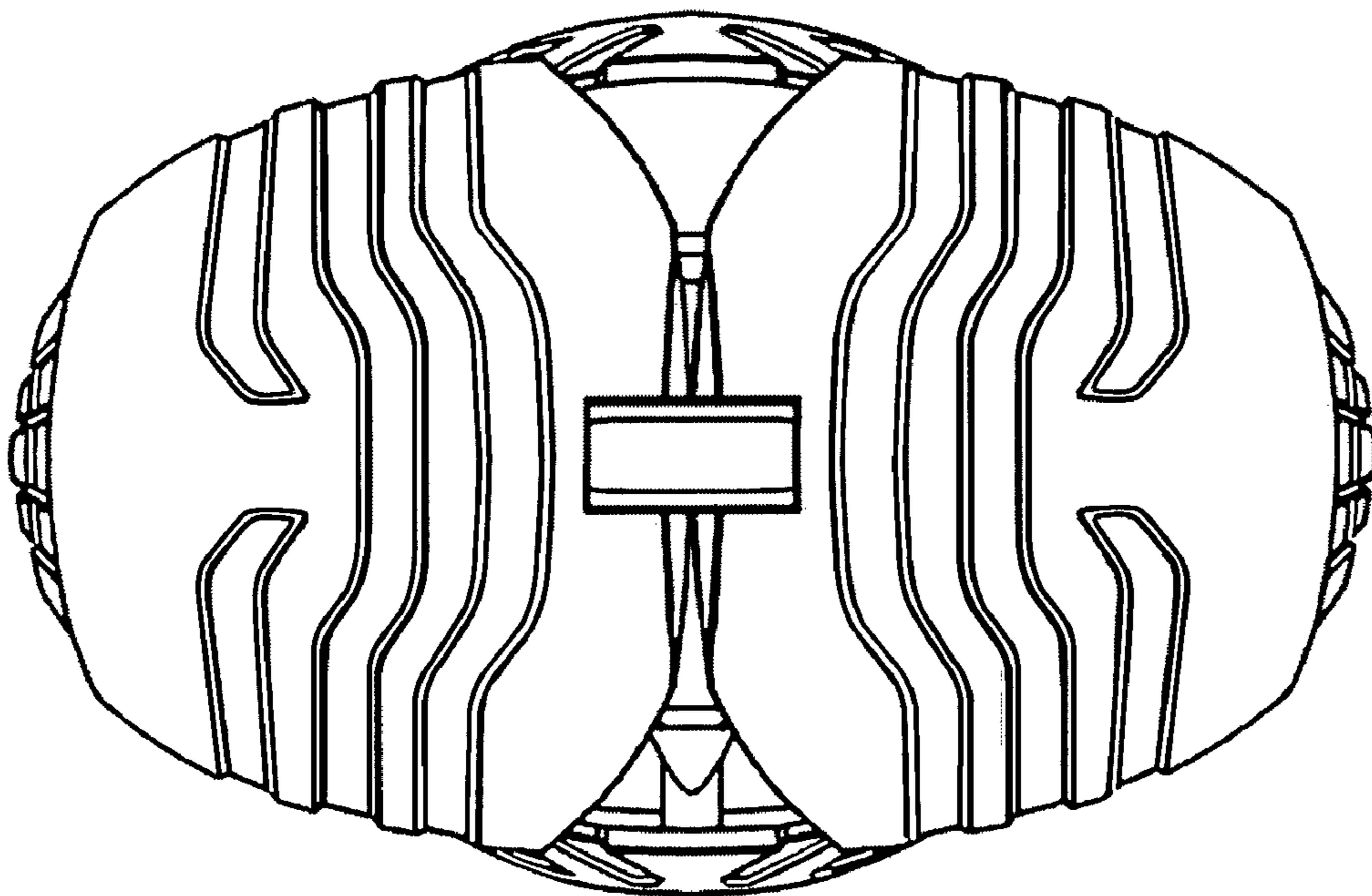

Fig. 3

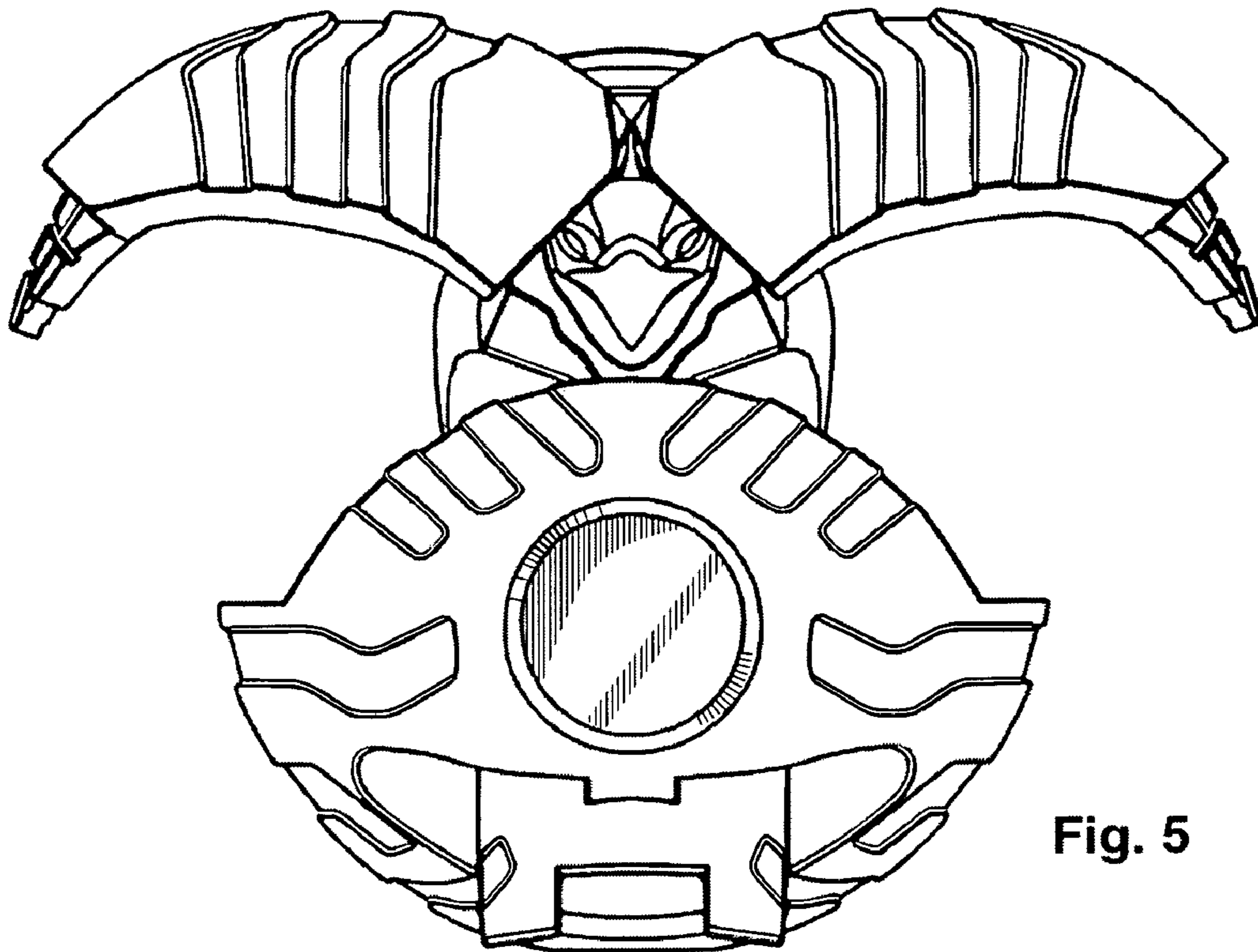

Fig. 5

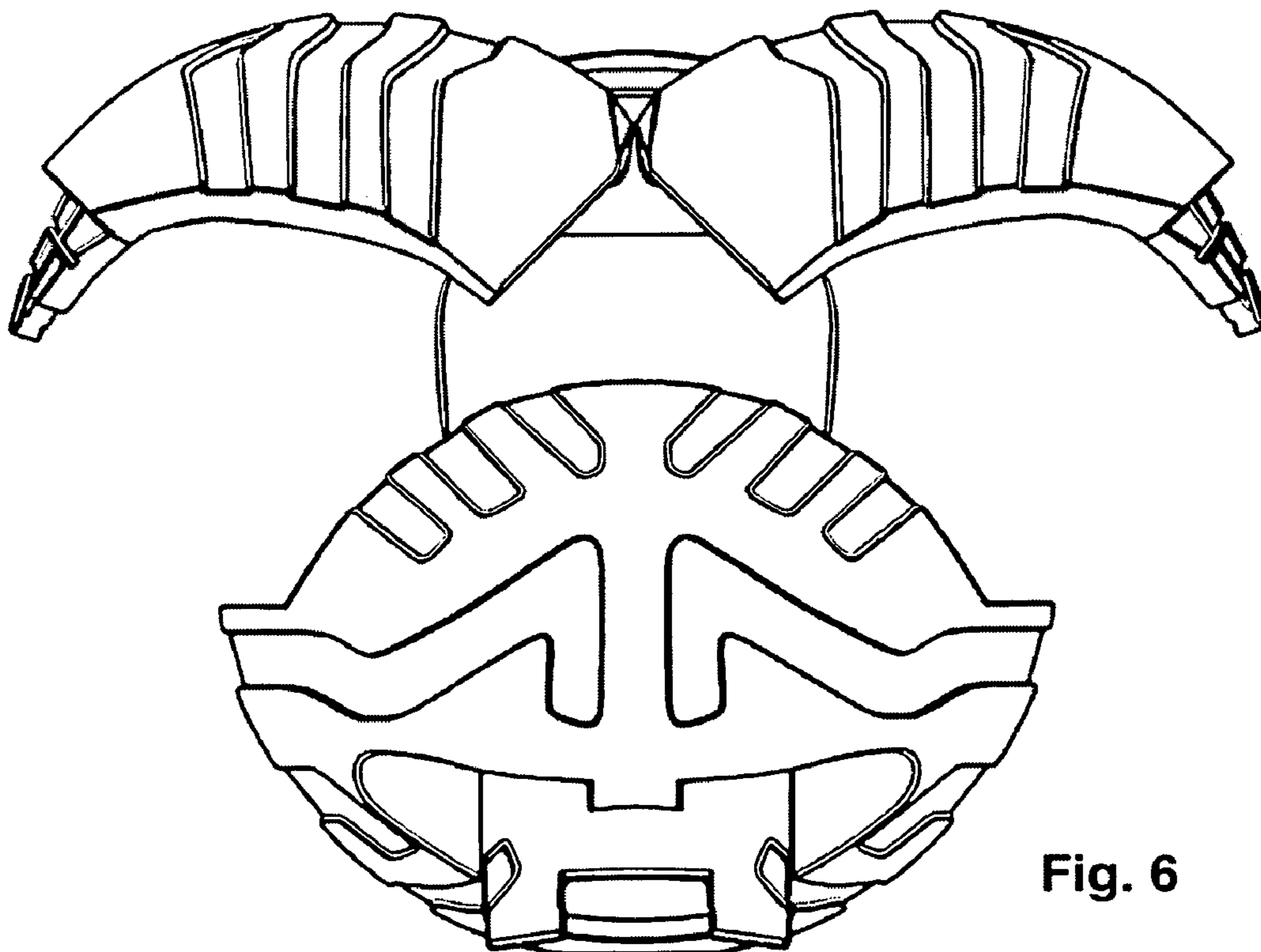

Fig. 6

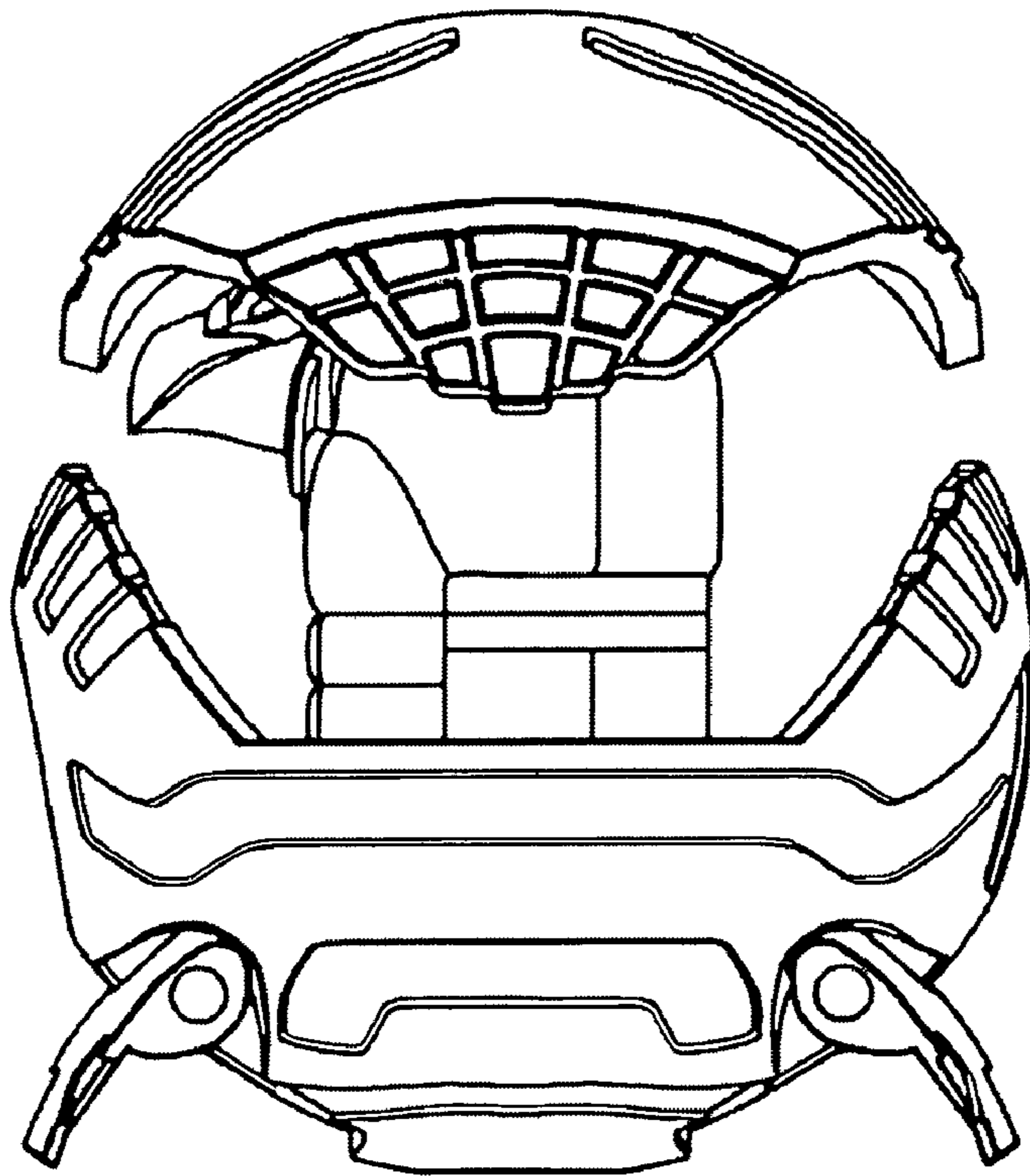

Fig. 7

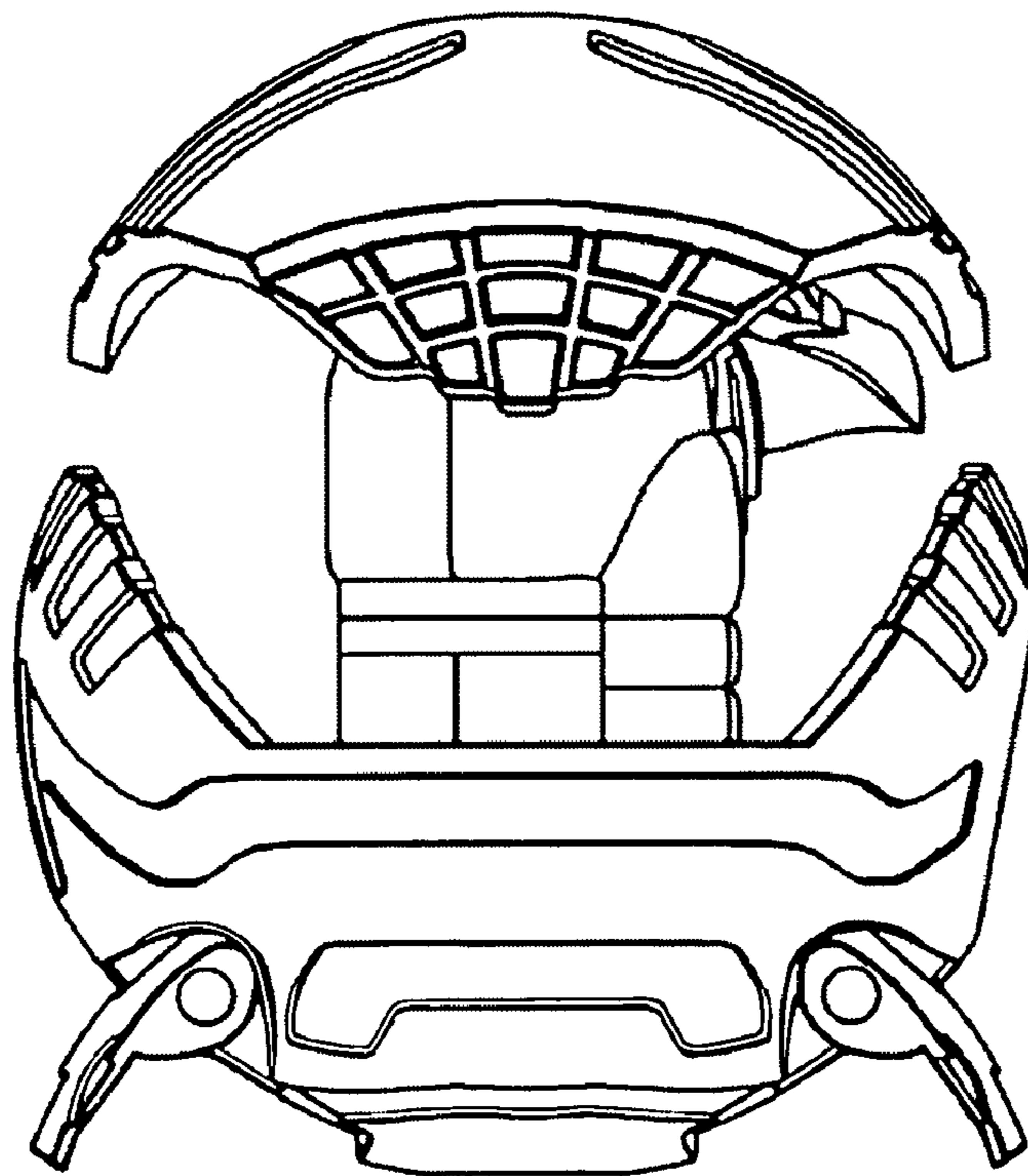

Fig. 8

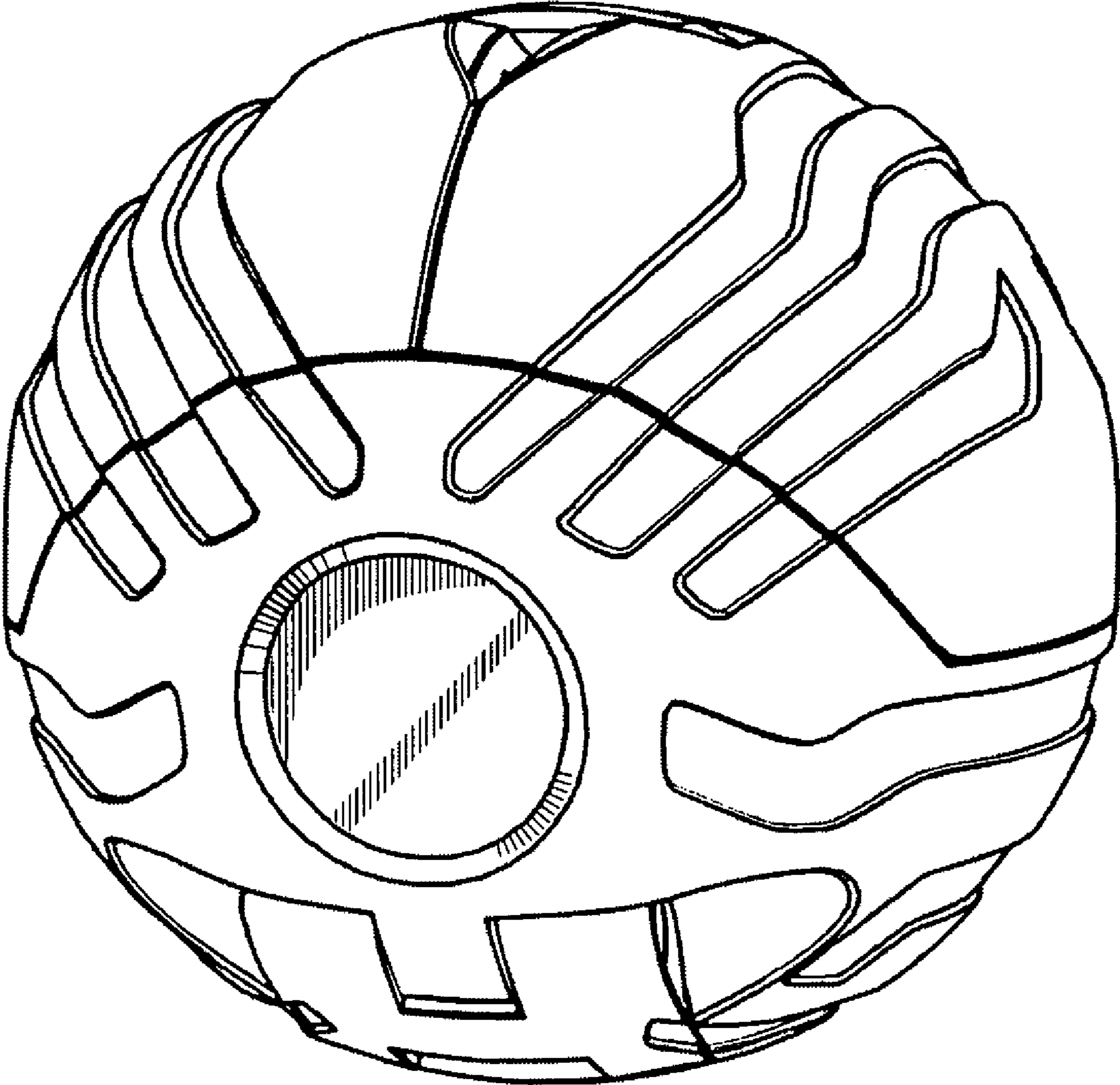

Fig. 9

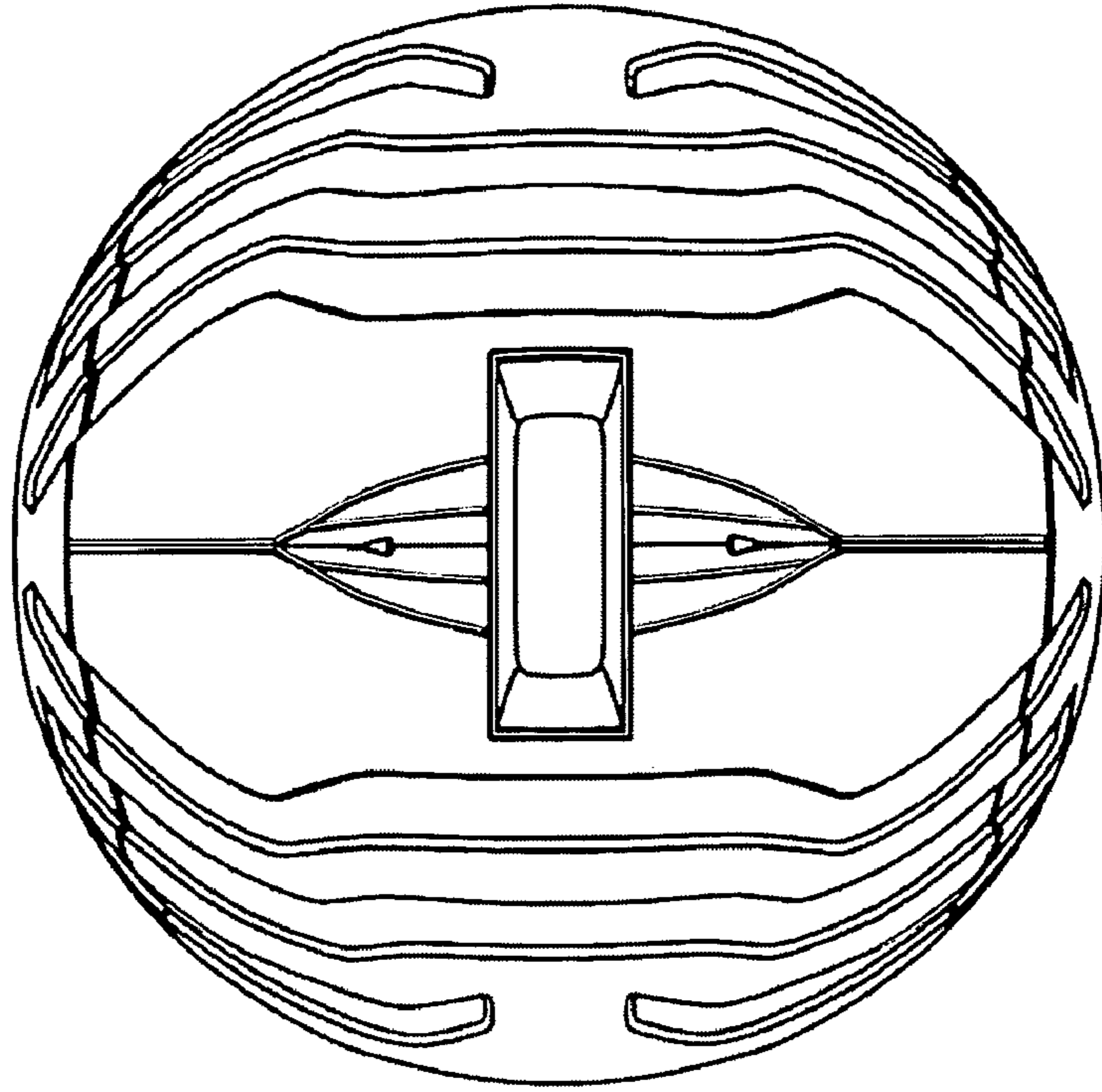

Fig. 10

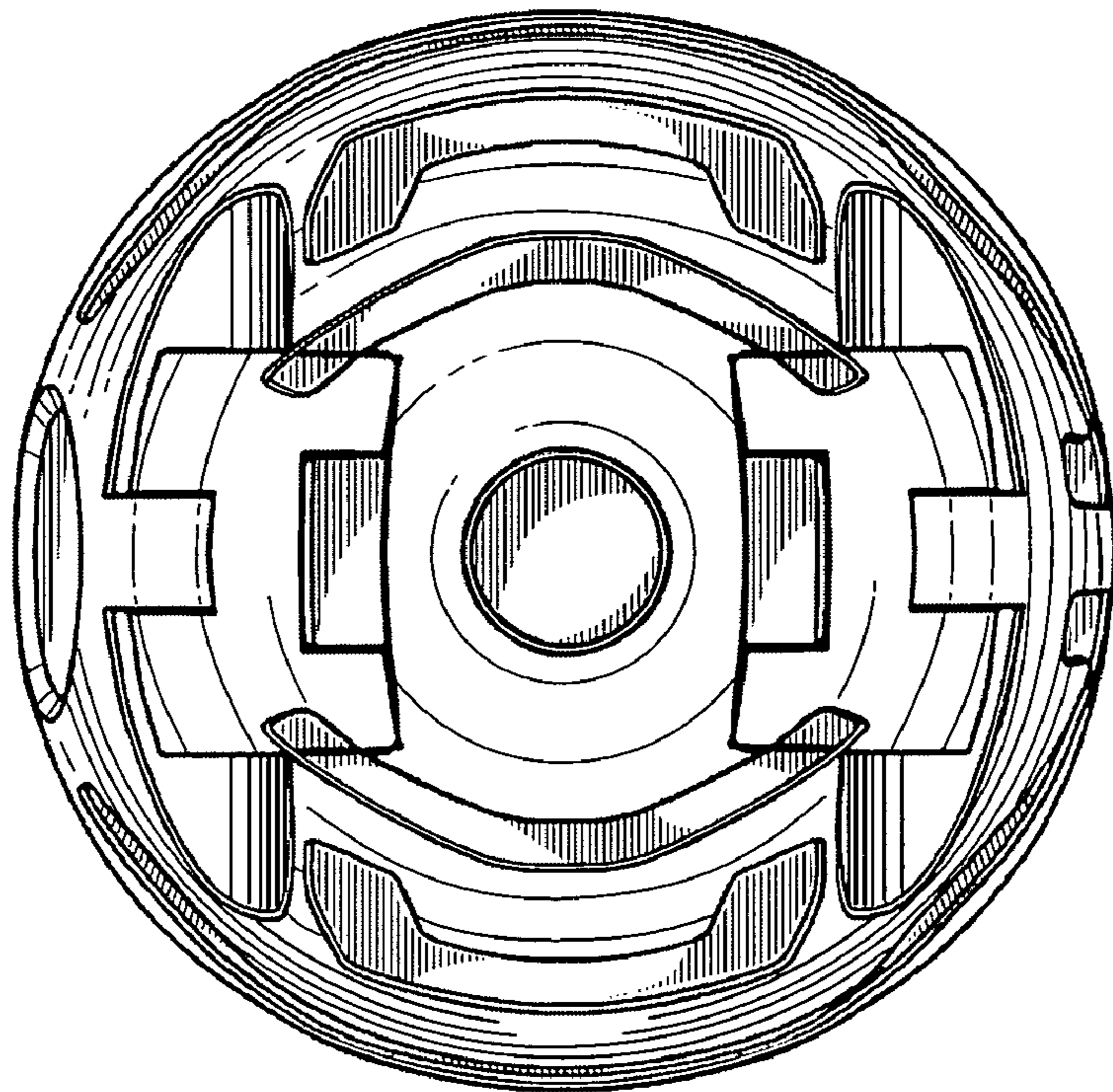

Fig. 11

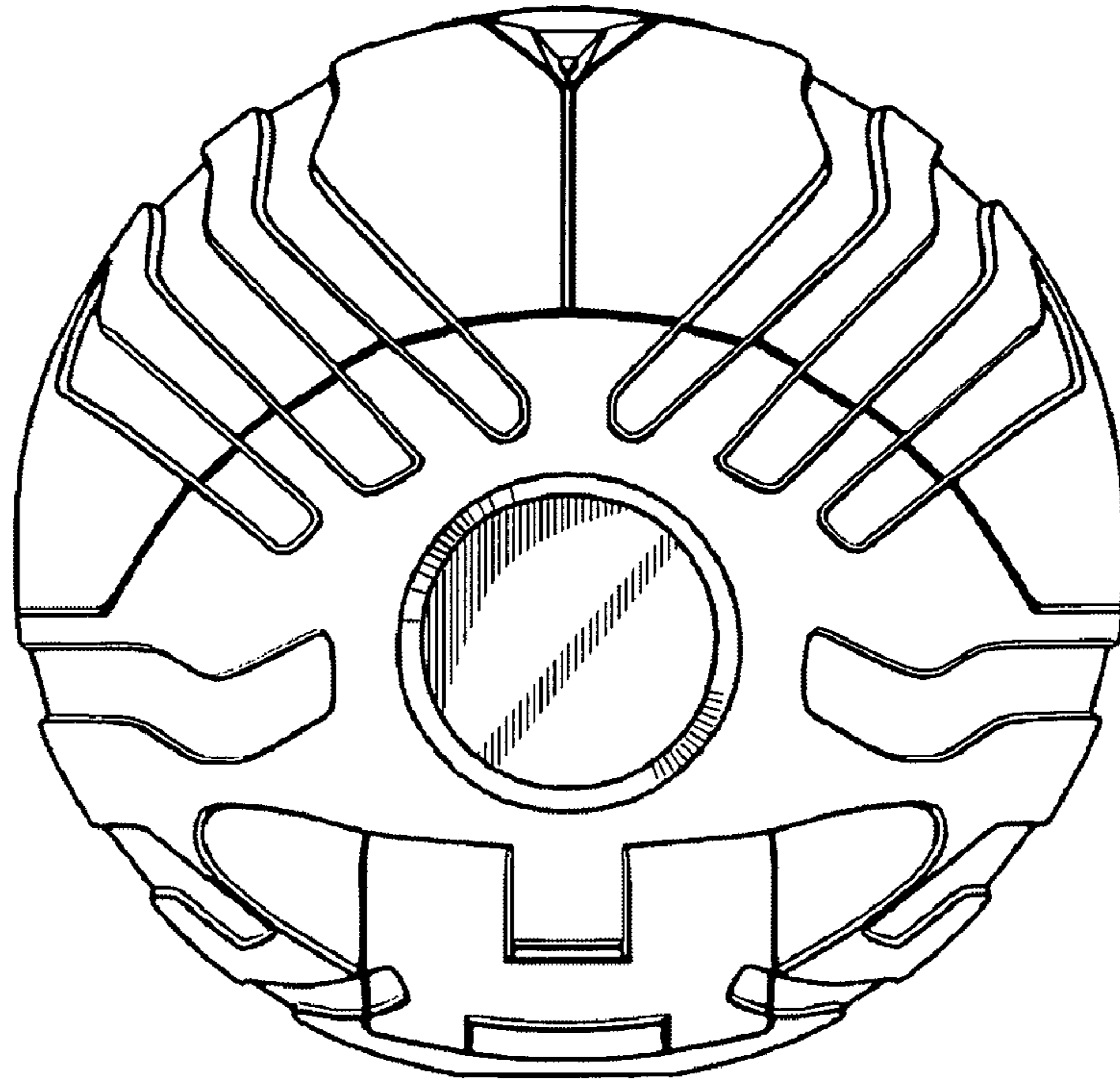

Fig. 12

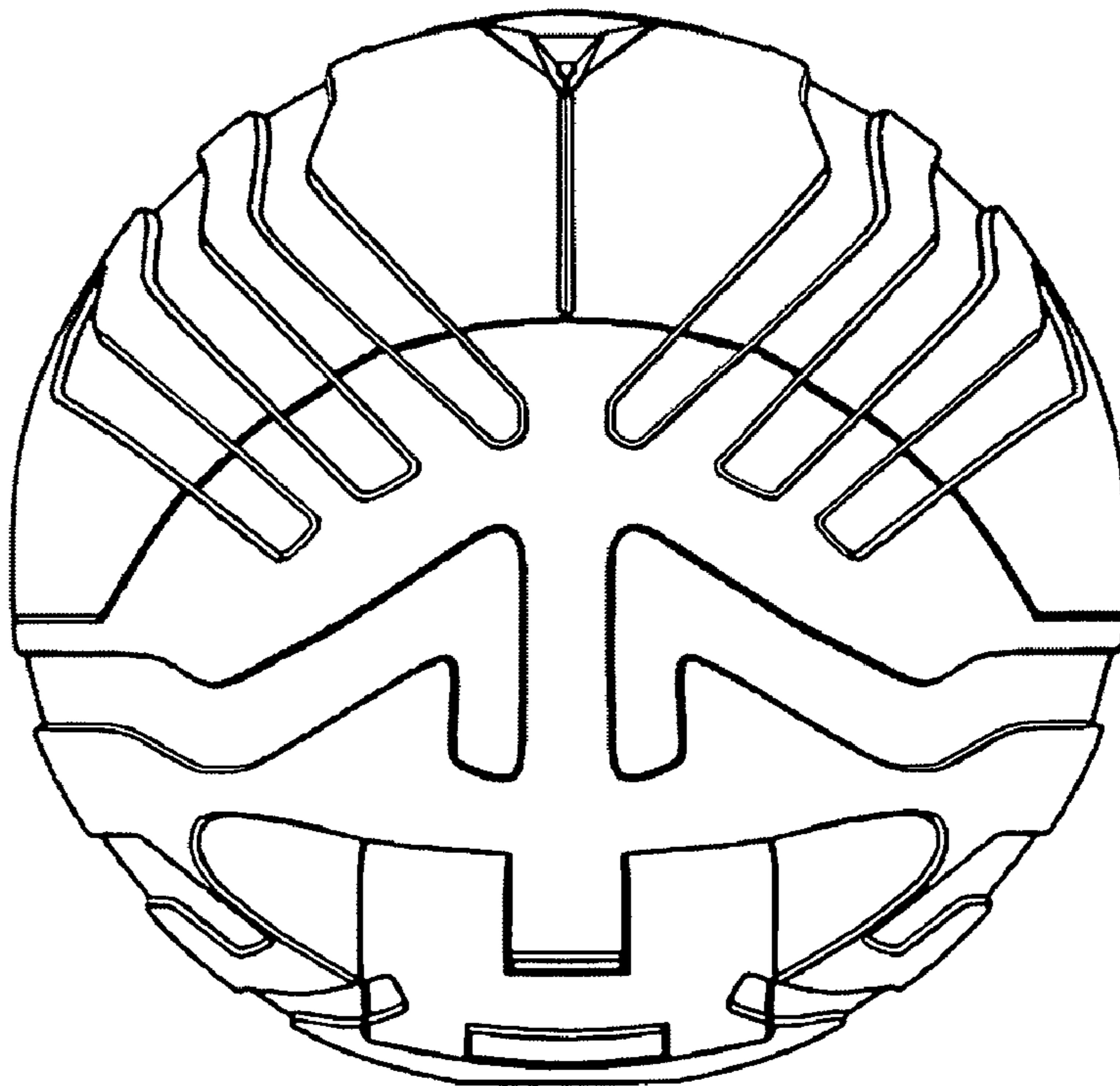

Fig. 13

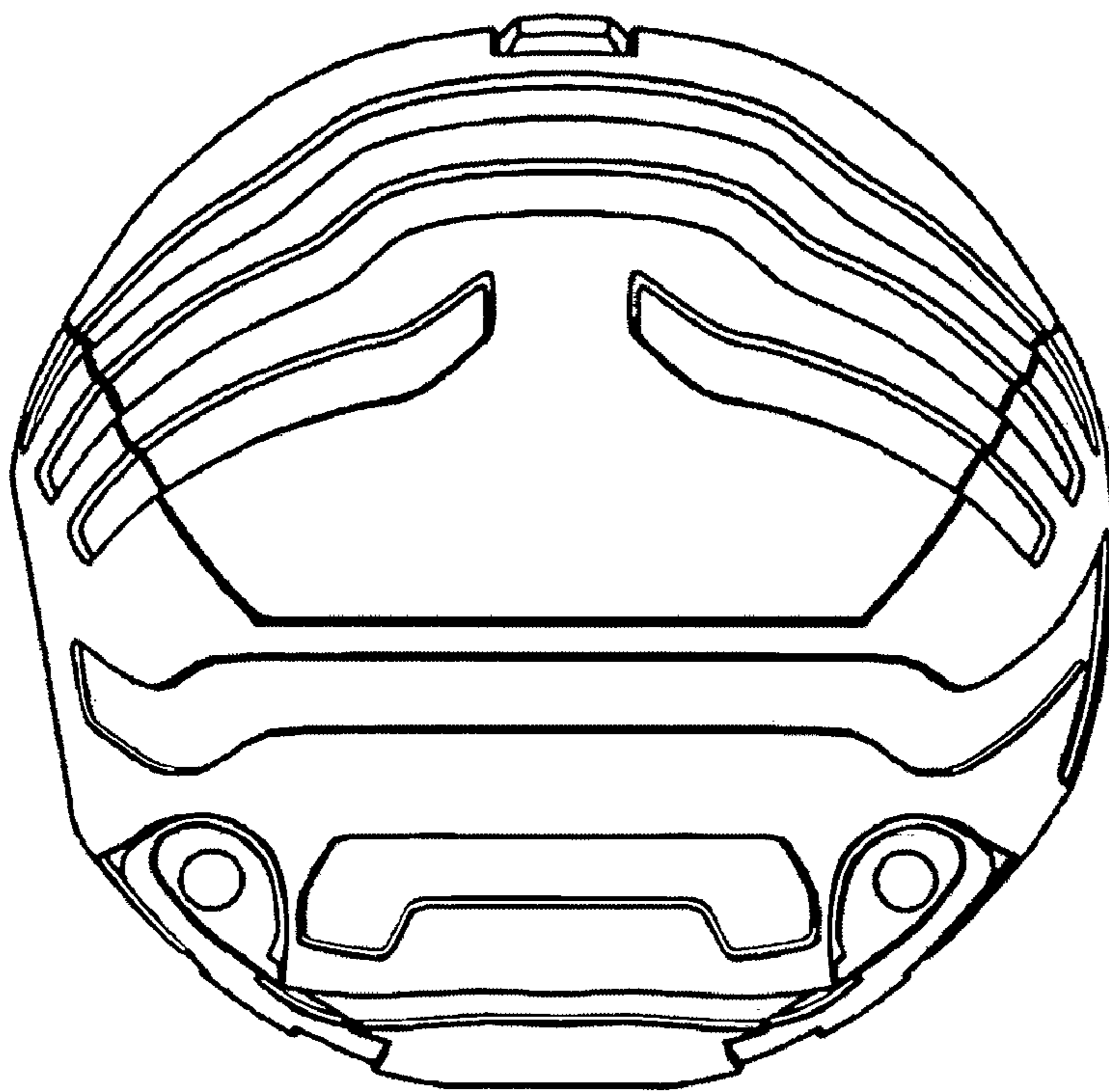

Fig. 14

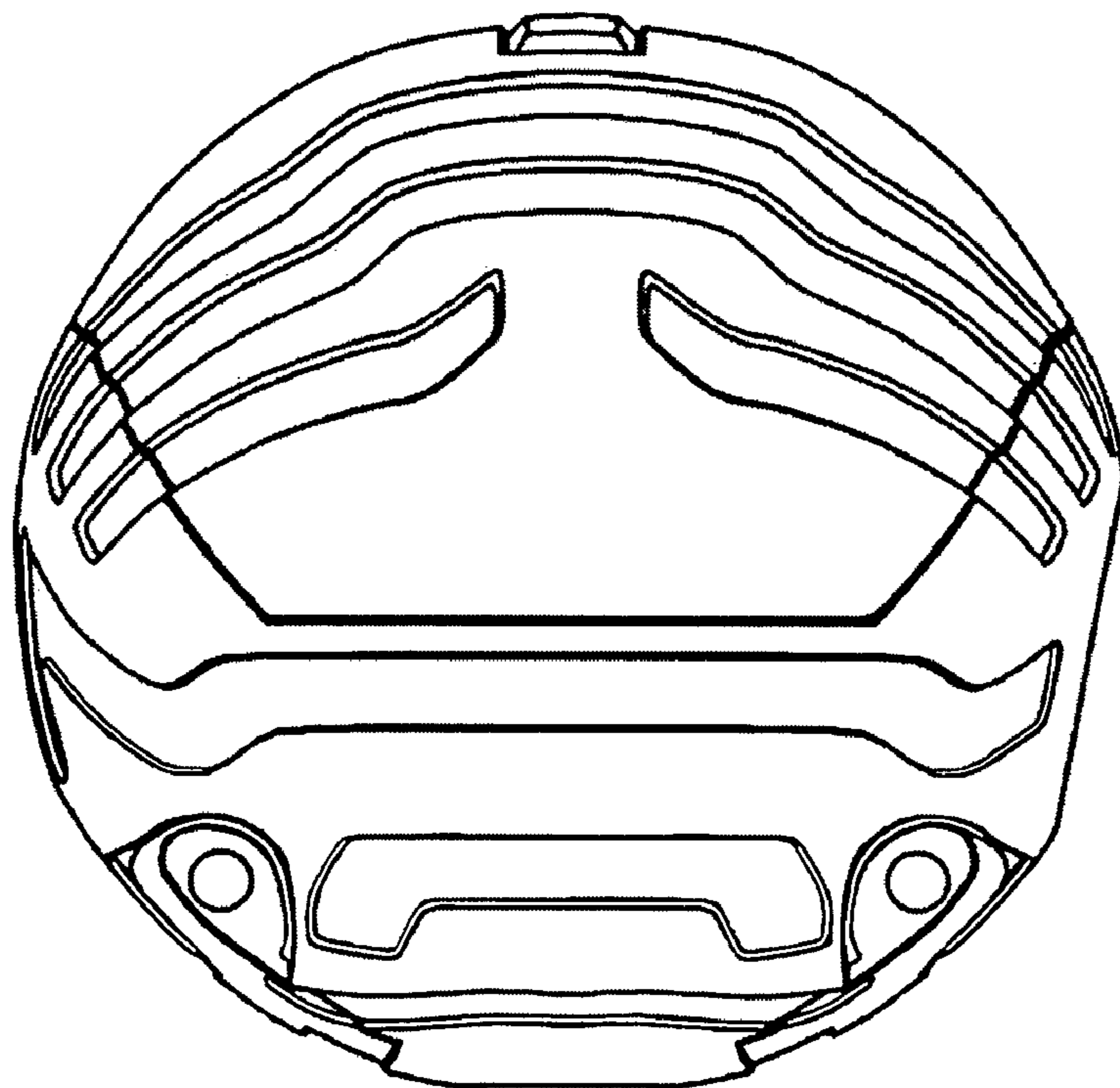

Fig. 15