



US00D589545S

(12) **United States Design Patent**
Murphy et al.

(10) **Patent No.:** **US D589,545 S**

(45) **Date of Patent:** **** Mar. 31, 2009**

(54) **OPTICAL FILTER ASSEMBLY**

(75) Inventors: **Peter J. Murphy**, Cold Spring Harbor, NY (US); **Kenneth Braganca**, Floral Park, NY (US)

(73) Assignee: **Designs For Visions, Inc.**, Ron Kon Koma, NY (US)

(**) Term: **14 Years**

(21) Appl. No.: **29/286,953**

(22) Filed: **May 22, 2007**

(51) **LOC (9) Cl.** **16-06**

(52) **U.S. Cl.** **D16/135**

(58) **Field of Classification Search** D16/130, D16/134, 135, 242; D3/264, 208; D14/239; 359/793, 798, 802, 803, 804, 805, 808, 809, 359/811, 821, 822; 206/316.1, 5.1; 446/219, 446/485; 362/30, 33, 293; D12/187, 188, D12/189; 356/30

See application file for complete search history.

(56) **References Cited**

U.S. PATENT DOCUMENTS

| | | | | |
|-----------|-----|---------|------------------|---------|
| 1,212,853 | A | 1/1917 | Victor | |
| 2,312,542 | A * | 3/1943 | Goodman | 359/793 |
| 2,394,946 | A * | 2/1946 | Stegeman | 359/808 |
| D154,911 | S * | 8/1949 | Dougherty | D14/239 |
| 2,905,054 | A * | 9/1959 | Logan | 359/819 |
| D243,394 | S * | 2/1977 | Nerad et al. | D16/135 |
| 4,763,986 | A * | 8/1988 | Sego | 359/798 |
| 4,894,760 | A | 1/1990 | Callahan | |
| D372,746 | S * | 8/1996 | Mathews | D21/483 |
| D416,927 | S * | 11/1999 | Jim | D16/135 |
| 6,102,556 | A | 8/2000 | Lieberman et al. | |
| D440,153 | S * | 4/2001 | Lin | D9/746 |
| D492,336 | S * | 6/2004 | Yip et al. | D16/135 |
| 6,761,467 | B2 | 7/2004 | Matthews et al. | |
| D494,610 | S * | 8/2004 | Allen | D16/135 |
| 6,785,038 | B2 | 8/2004 | Hichawa et al. | |
| D522,549 | S * | 6/2006 | Jupiter | D16/130 |

| | | | | |
|-----------|------|---------|---------------|---------|
| D526,340 | S * | 8/2006 | Hodgson | D16/135 |
| D527,756 | S * | 9/2006 | Parker et al. | D16/242 |
| 7,289,282 | B2 * | 10/2007 | Matsushima | 359/819 |

* cited by examiner

Primary Examiner—Paula Greene

(74) *Attorney, Agent, or Firm*—The Plevy Law Firm

(57) **CLAIM**

The ornamental design for an optical filter assembly, as shown and described.

DESCRIPTION

FIG. 1 is a perspective view of an optical filter assembly showing our new design;

FIG. 2 is a front elevational view thereof;

FIG. 3 is a rear elevational view thereof;

FIG. 4 is a left side elevational view thereof;

FIG. 5 is a right side elevational view thereof;

FIG. 6 is top plan view thereof;

FIG. 7 is a bottom plan view thereof;

FIG. 8 is a perspective view of the optical filter assembly of FIG. 1, with the frame portion rotated 180 degrees from its position in FIG. 1.

FIG. 9 is a front elevational view of the optical filter assembly in the position shown in FIG. 8.

FIG. 10 is a rear elevational view of the optical filter assembly in the position shown in FIG. 8;

FIG. 11 is a left side elevational view of the optical filter assembly in the position shown in FIG. 8;

FIG. 12 is a right side elevational view of the optical filter assembly in the position shown in FIG. 8;

FIG. 13 is a top plan view of the optical filter assembly in the position shown in FIG. 8; and,

FIG. 14 is a bottom plan view of the optical filter assembly in the position shown in FIG. 8.

1 Claim, 12 Drawing Sheets

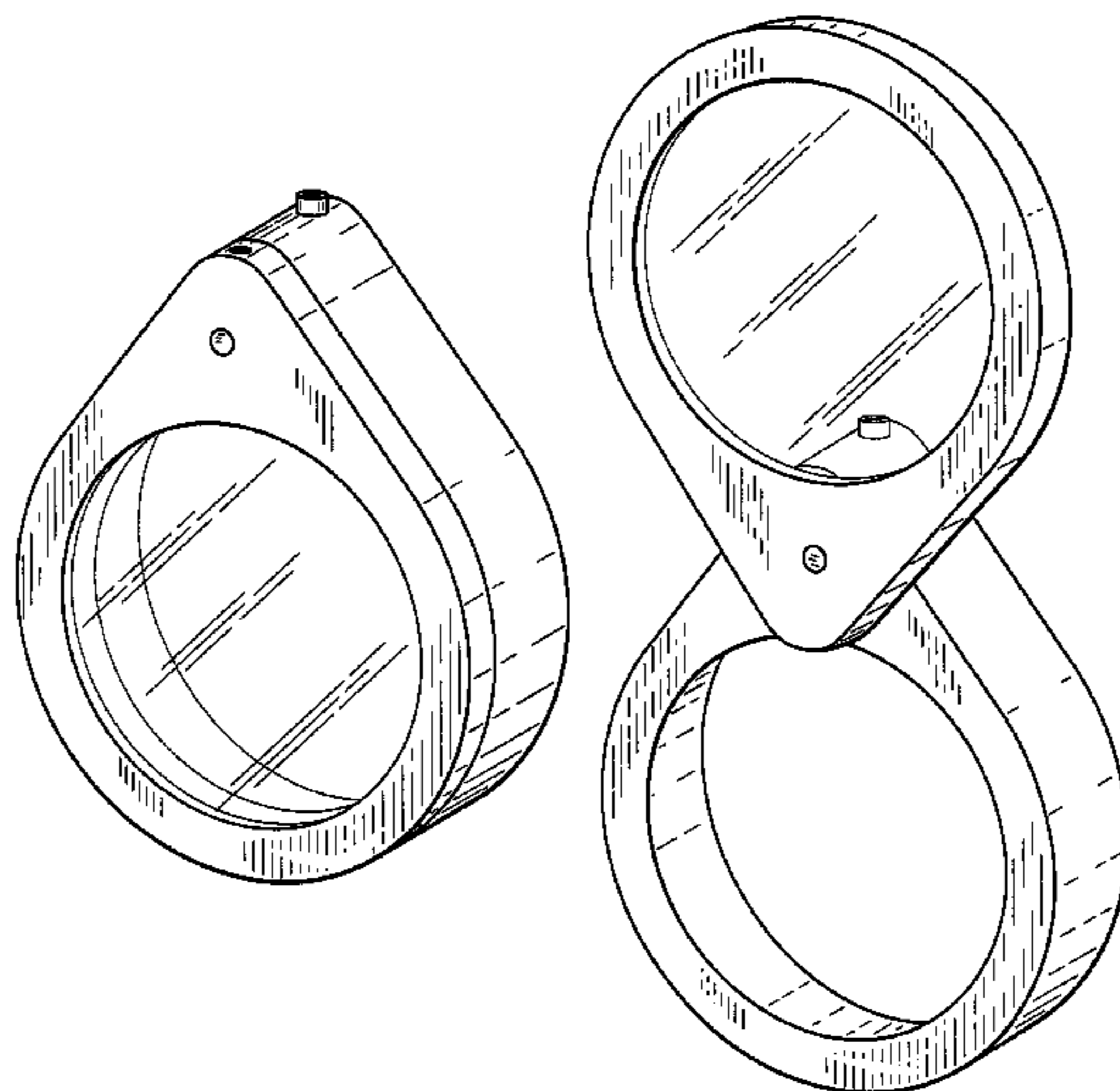

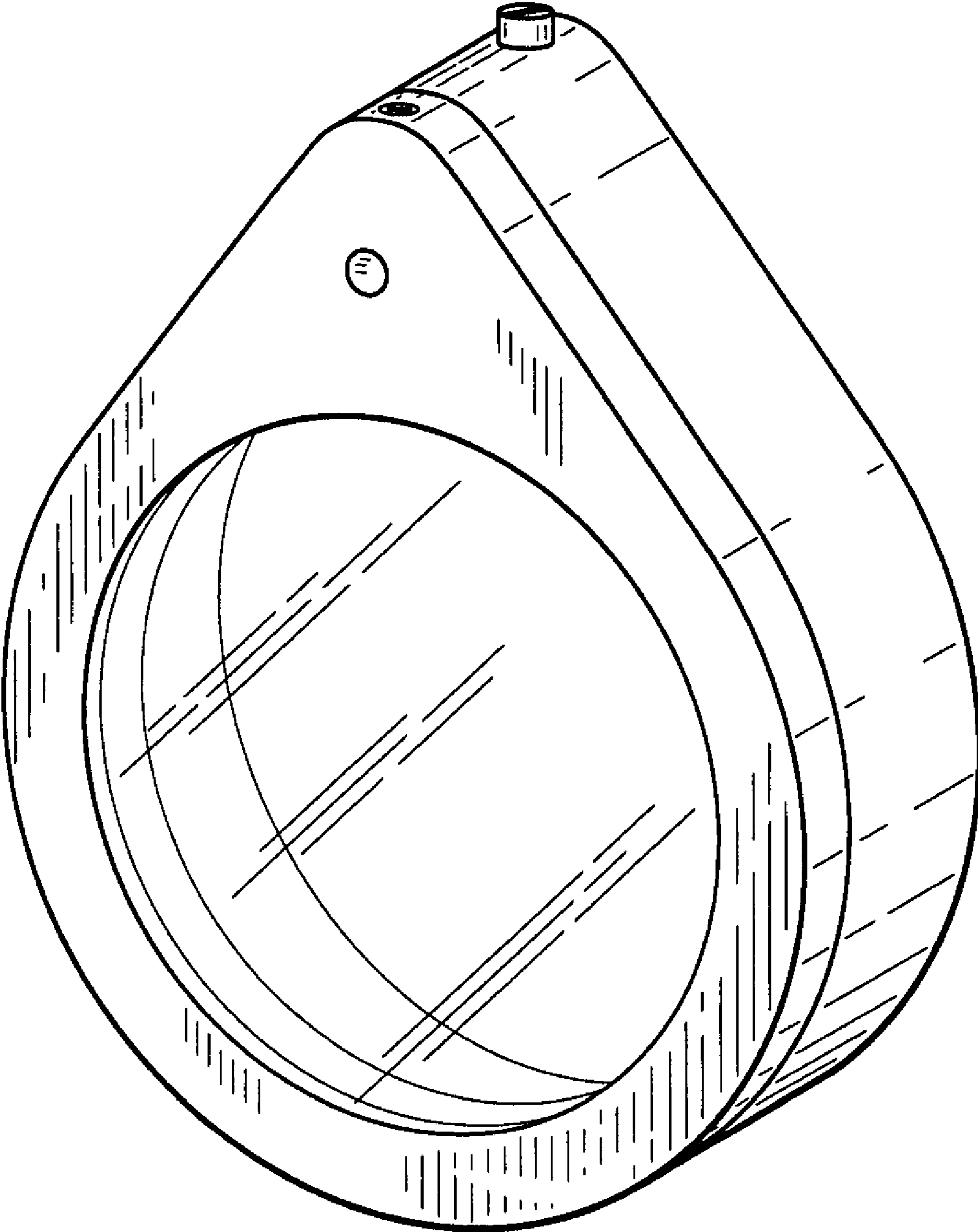

FIG. 1

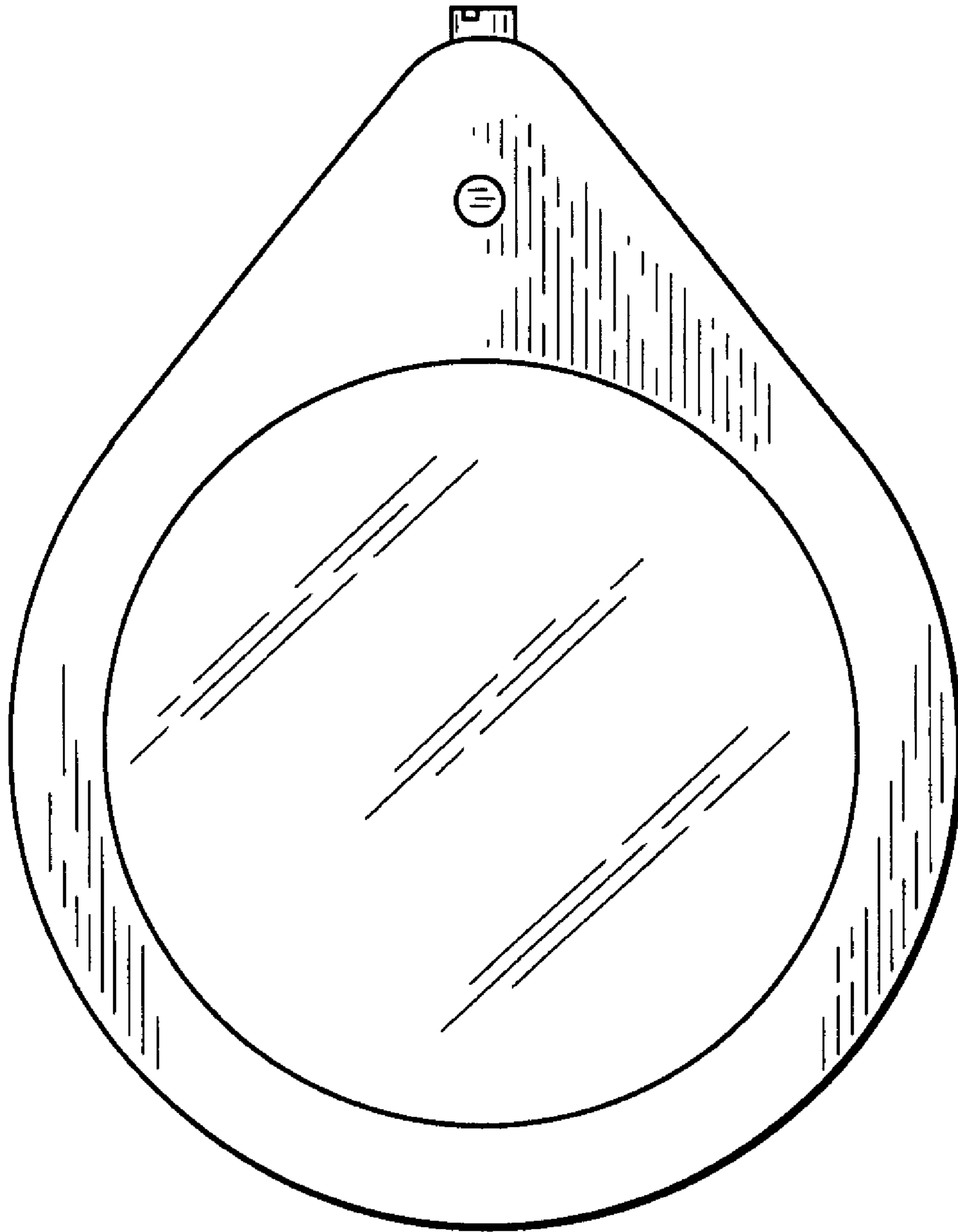

FIG. 2

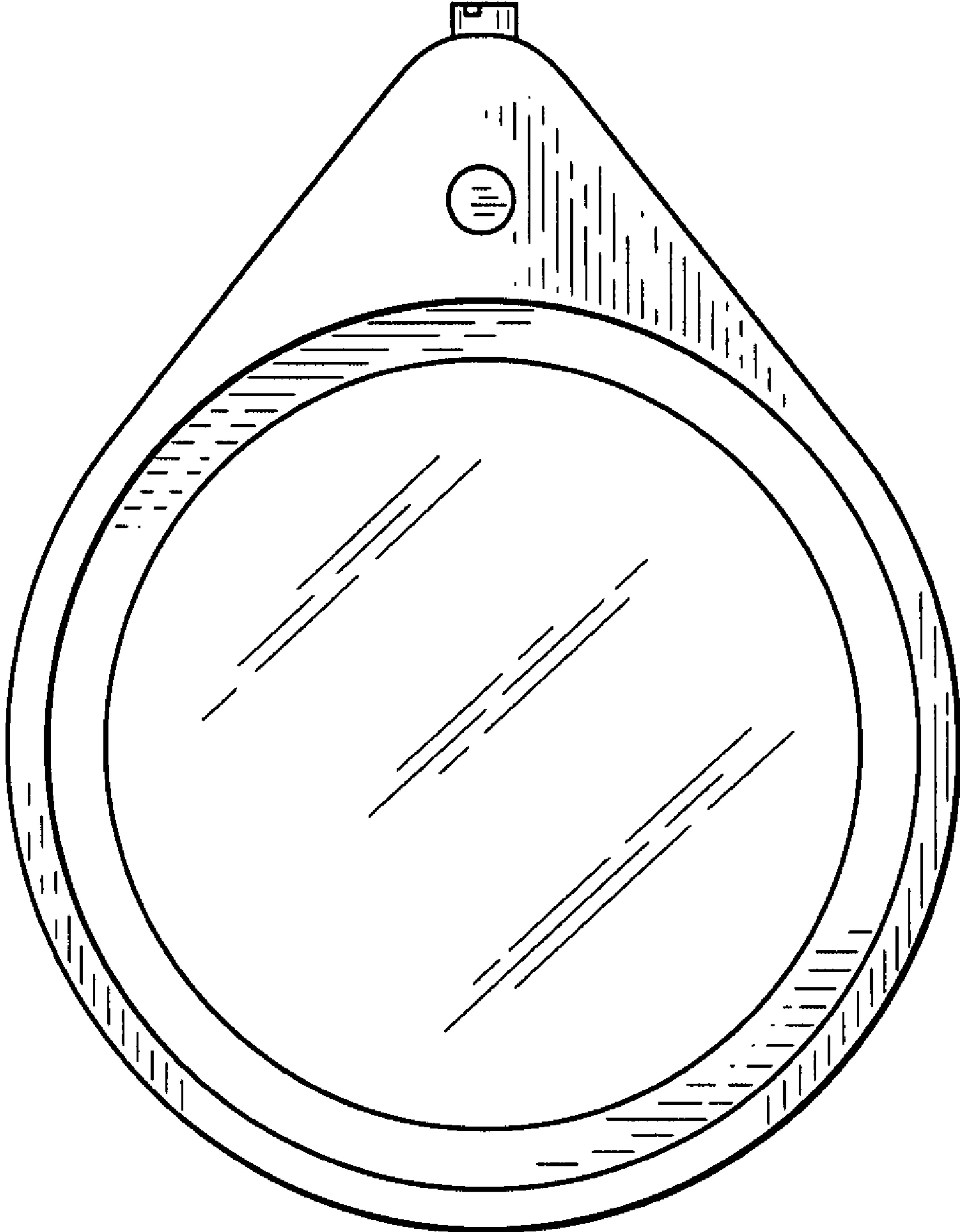

FIG. 3

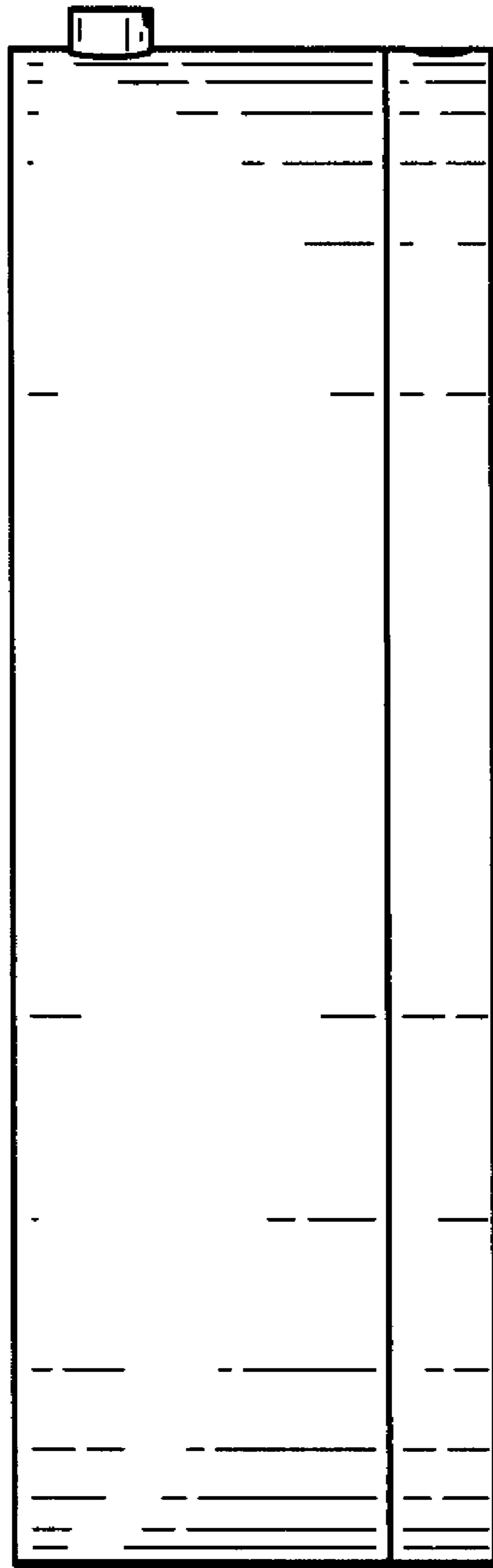

FIG. 4

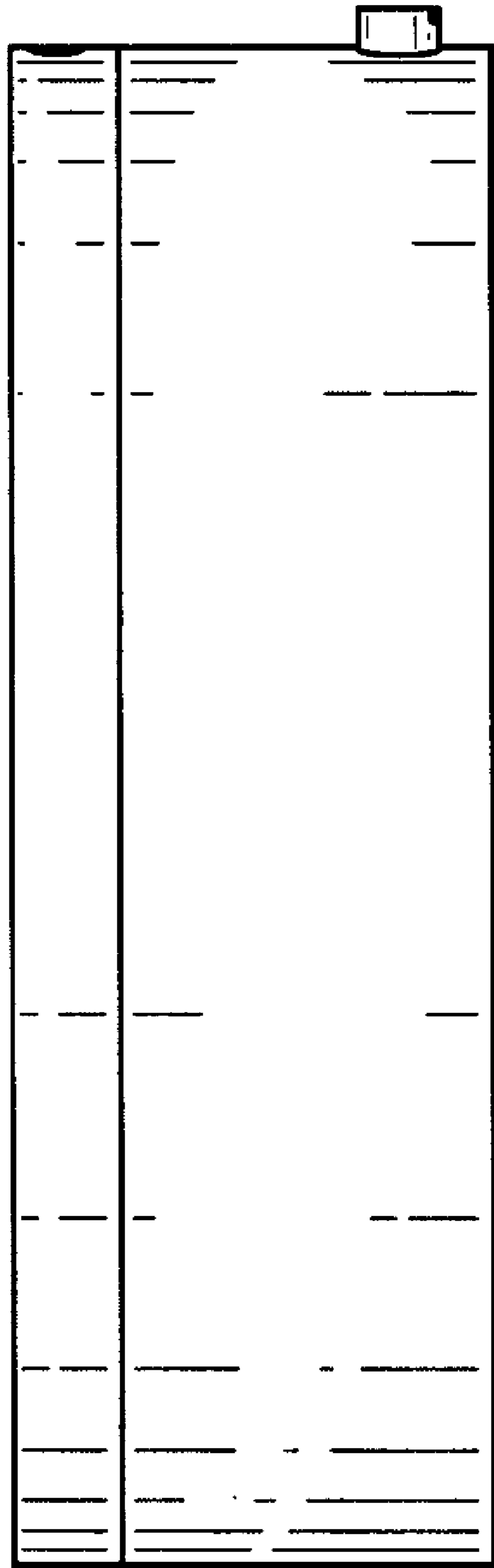

FIG. 5

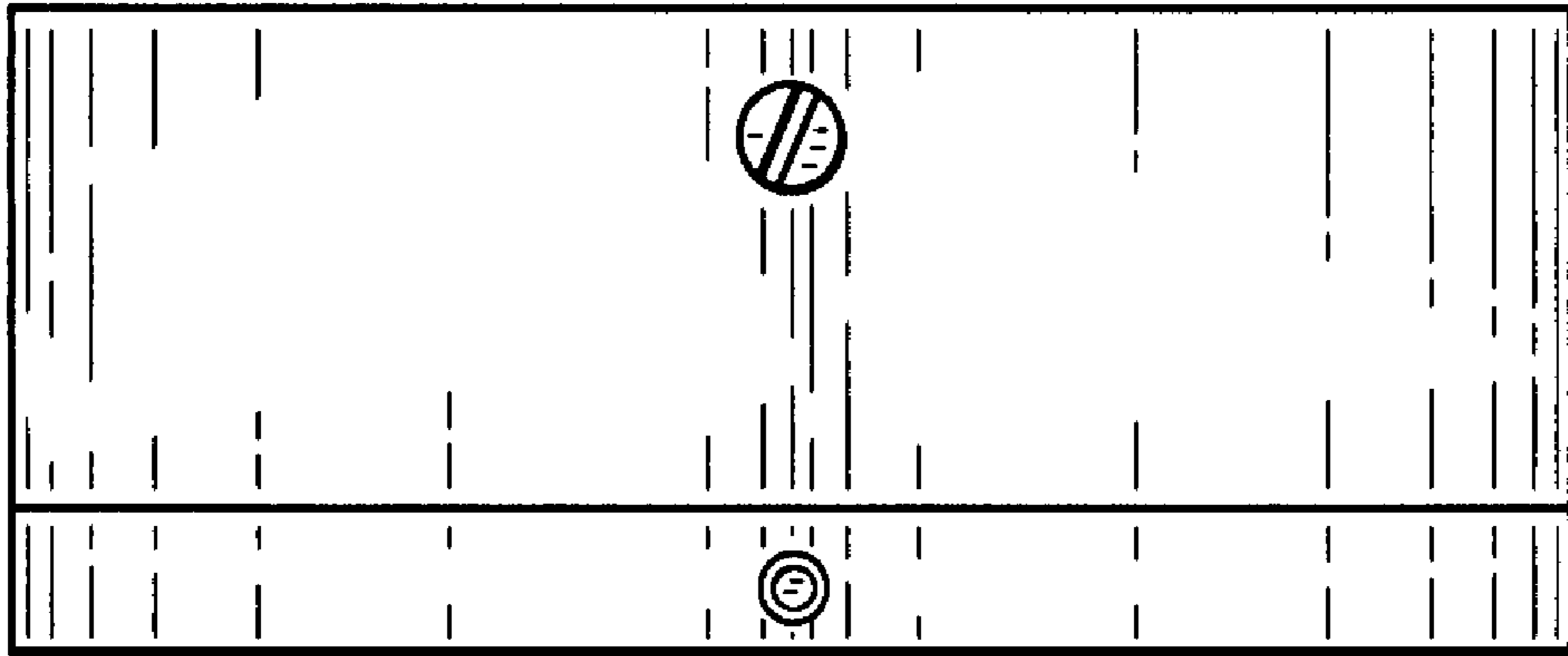

FIG. 6

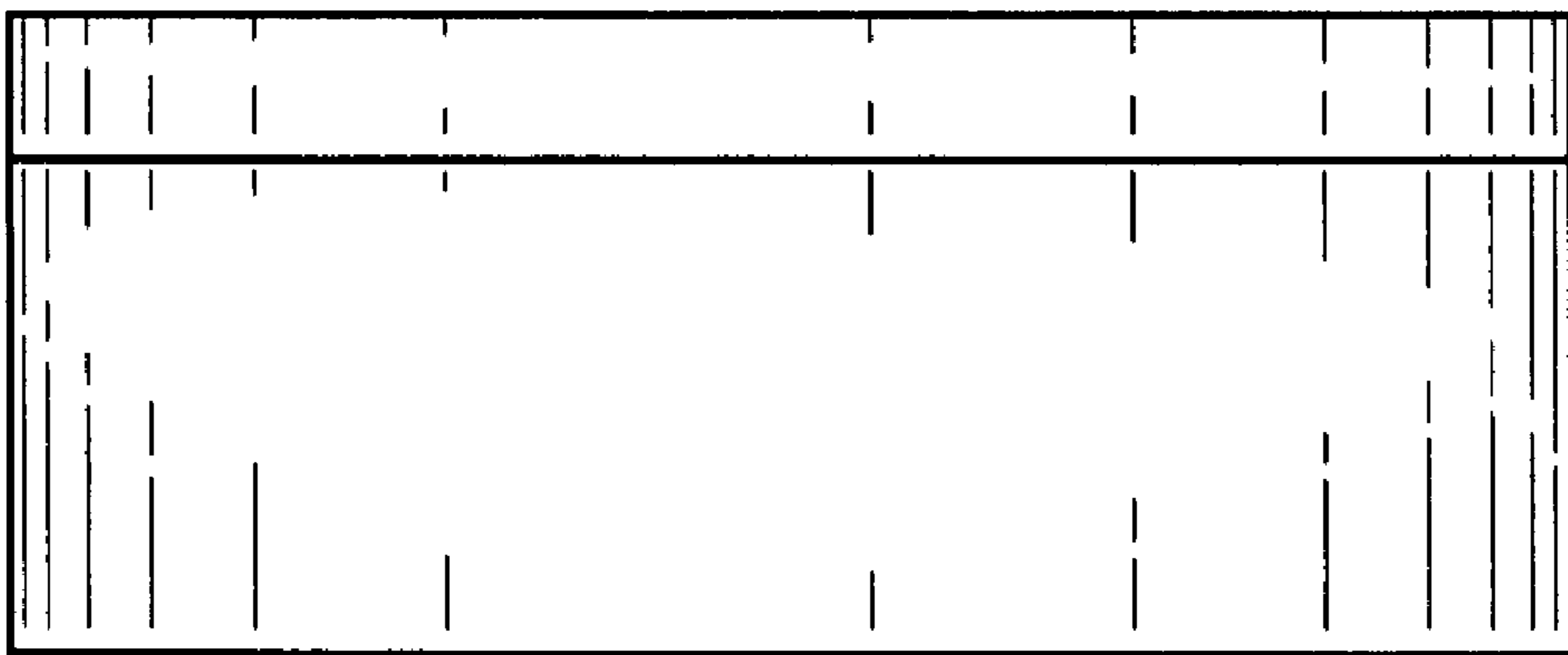

FIG. 7

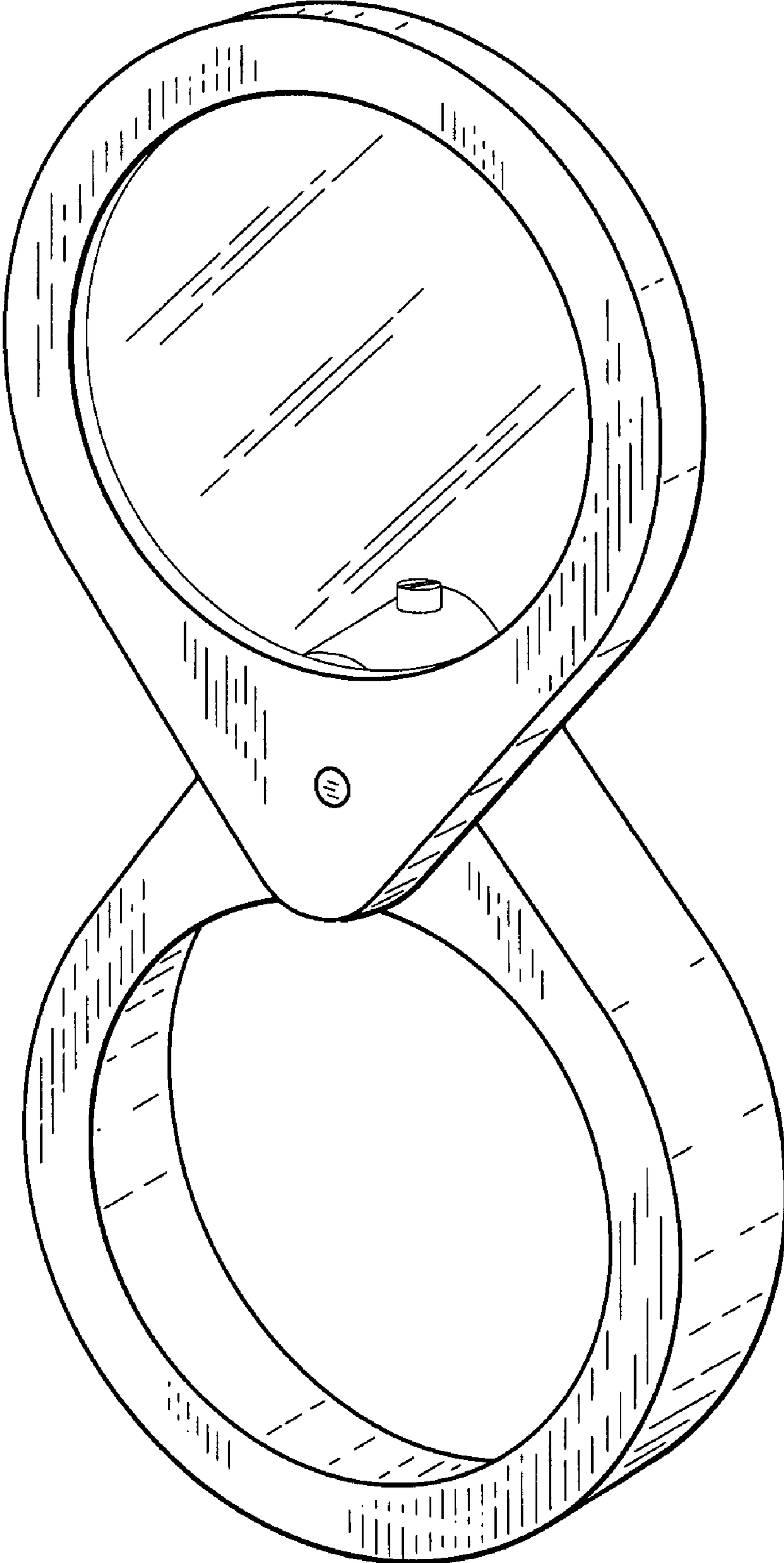

FIG. 8

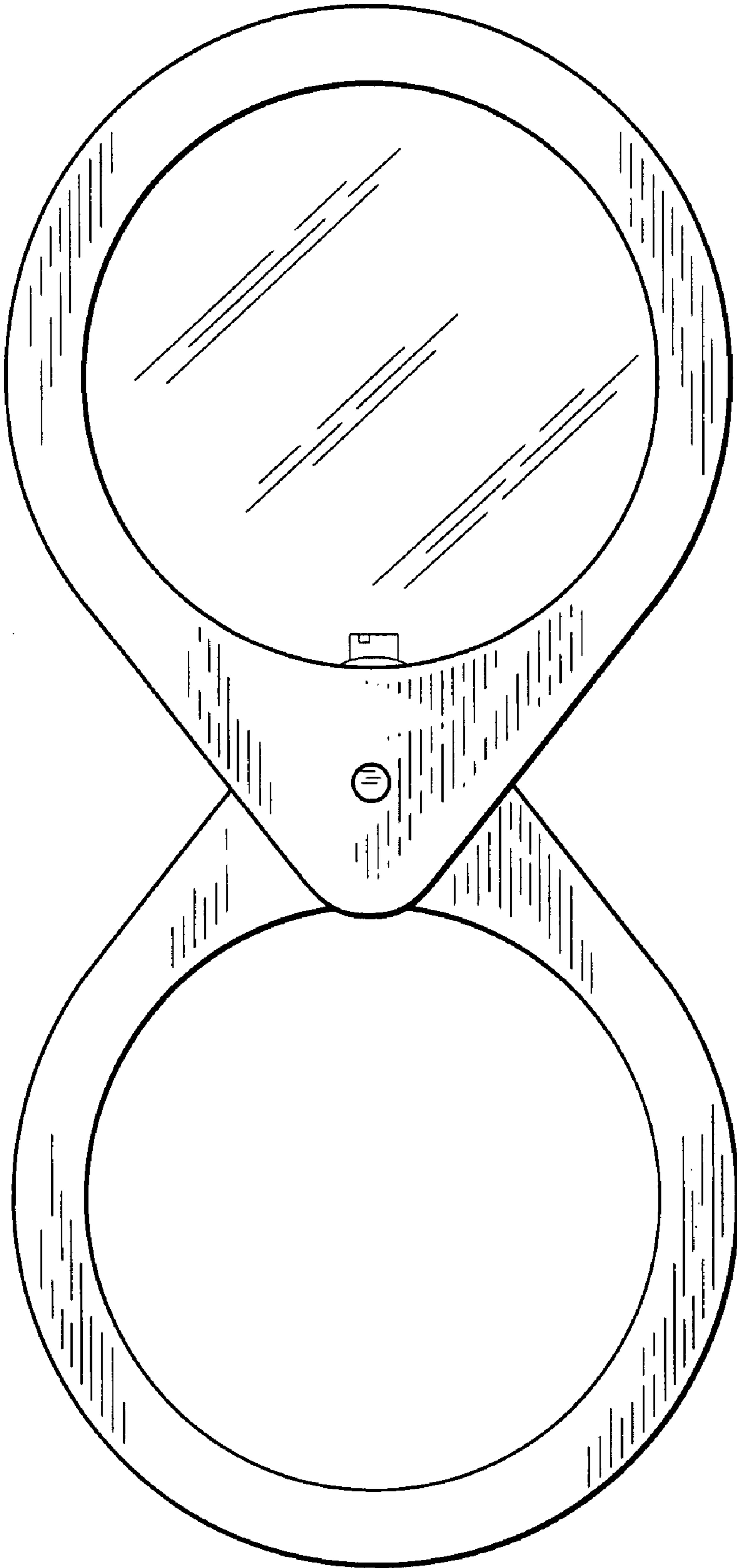

FIG. 9

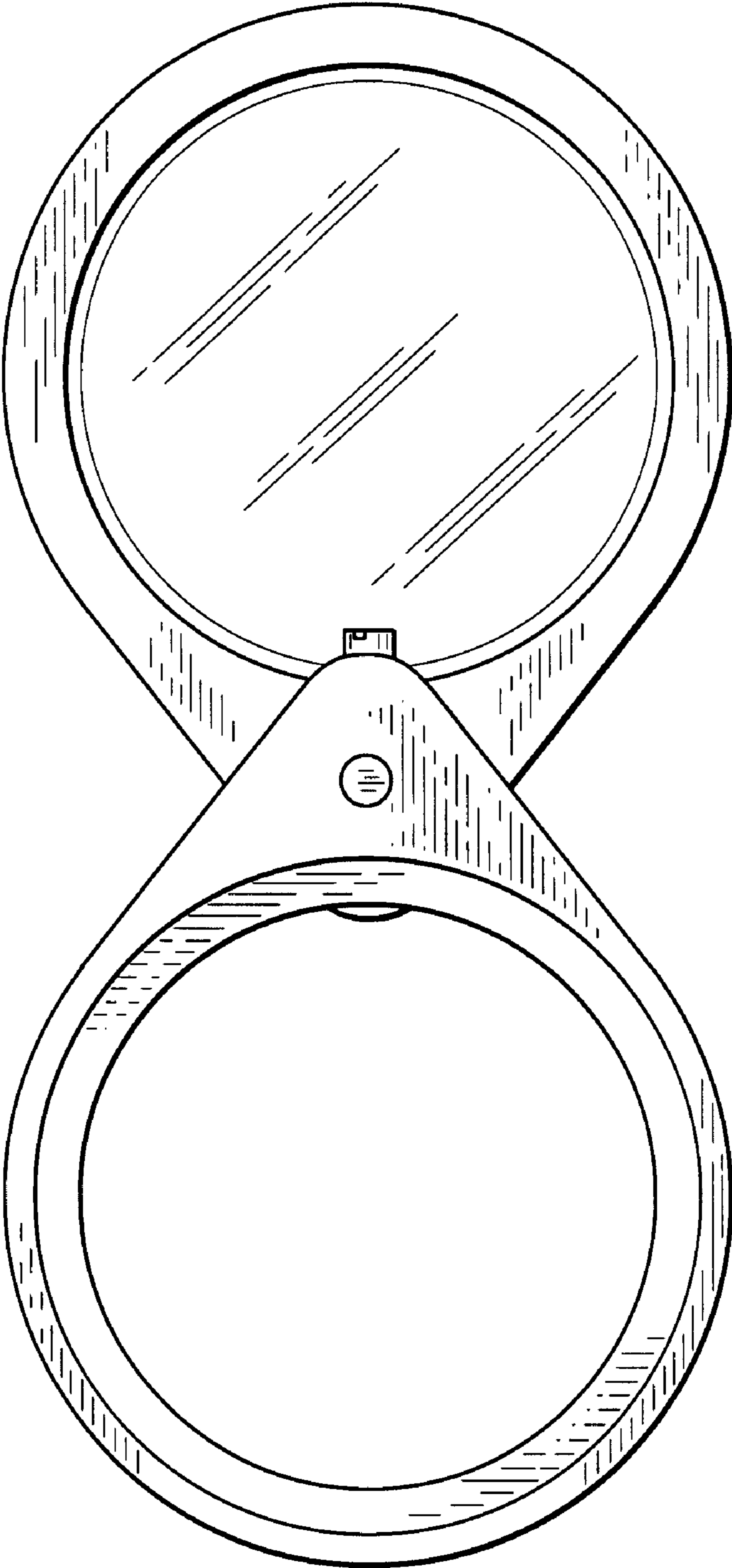

FIG. 10

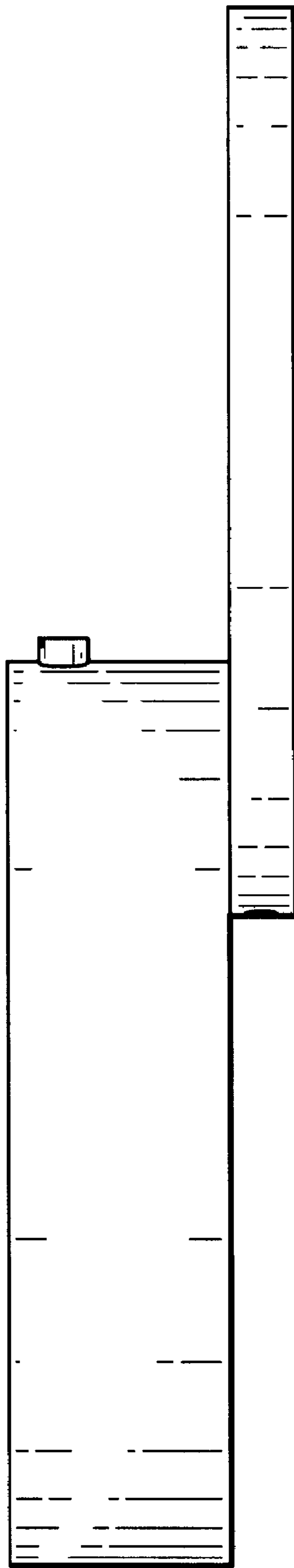

FIG. 11

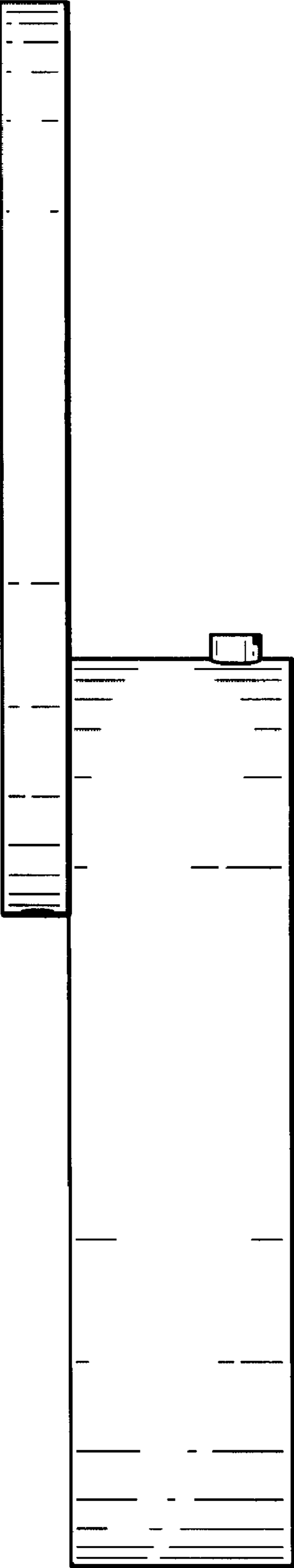

FIG. 12

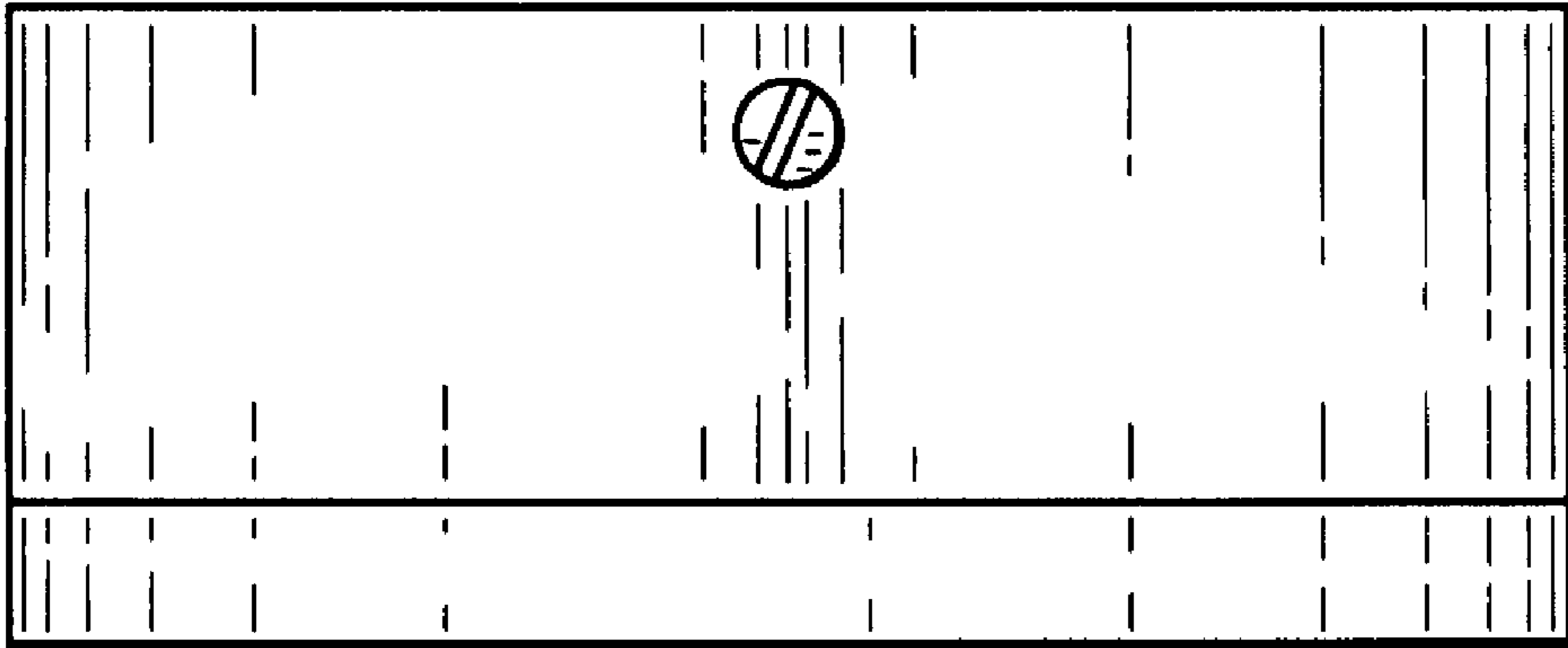

FIG. 13

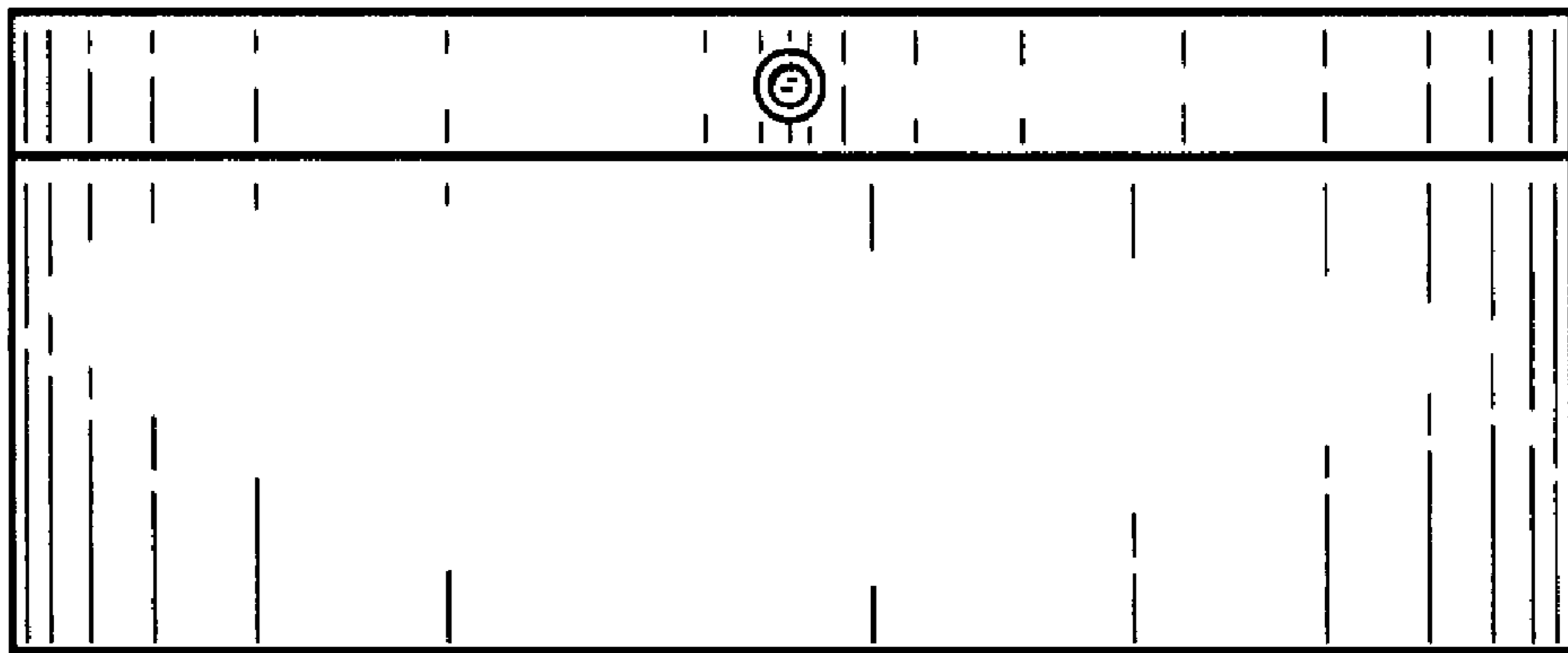

FIG. 14