



US00D589332S

(12) **United States Design Patent**  
**Bevirt**

(10) **Patent No.:** **US D589,332 S**

(45) **Date of Patent:** **\*\* Mar. 31, 2009**

(54) **SUCTION CUP CLIP**

2008/0217493 A1\* 9/2008 Bevirt ..... 248/163.1

(75) Inventor: **Joeben Bevirt**, Santa Cruz, CA (US)

\* cited by examiner

(73) Assignee: **Joby Photo, Inc.**, San Francisco, CA (US)

*Primary Examiner*—Robert M Spear

*Assistant Examiner*—Barbara B Lohr

(74) *Attorney, Agent, or Firm*—Michael A. Guth

(\*\*) Term: **14 Years**

(57) **CLAIM**

(21) Appl. No.: **29/294,353**

The ornamental design for a suction cup clip, as shown and described.

(22) Filed: **Jan. 7, 2008**

(51) **LOC (9) Cl.** ..... **08-05**

(52) **U.S. Cl.** ..... **D8/373**

(58) **Field of Classification Search** ..... D8/354,  
D8/363, 373; D14/209, 224, 229, 251, 253,  
D14/451, 447; 248/124.1, 163.1, 206.2,  
248/206.3, 206.5, 240, 274.1, 284.1, 291.1,  
248/309.1; D12/415; 4/571.1, 574.1; 362/109  
See application file for complete search history.

**DESCRIPTION**

The claimed ornamental design for suction cup clip which embodies the design is for use as a clip for a support structure such as a tripod.

FIG. 1 is a front view of a suction cup clip showing our new design;

FIG. 2 is a rear view thereof;

FIG. 3 is a right side view thereof;

FIG. 4 is a left view thereof;

FIG. 5 is a reduced scale bottom view thereof;

FIG. 6 is a cross-sectional view thereof;

FIG. 7 is an enlarged top view thereof; and,

FIG. 8 is a bottom perspective view thereof.

The broken lines in the figures illustrate the portions of the design that form no part of the claimed design.

(56) **References Cited**

**U.S. PATENT DOCUMENTS**

- D543,439 S \* 5/2007 Brassard ..... D8/363
- D551,065 S \* 9/2007 Hajianpour ..... D8/373
- D554,042 S \* 10/2007 Richter ..... D12/415
- D560,116 S \* 1/2008 Brassard ..... D8/380
- D560,592 S \* 1/2008 Brassard ..... D12/415
- D576,475 S \* 9/2008 Didehvar ..... D8/373
- D576,476 S \* 9/2008 Didehvar ..... D8/373
- 2007/0097670 A1\* 5/2007 Matthew et al. .... 362/109

**1 Claim, 7 Drawing Sheets**

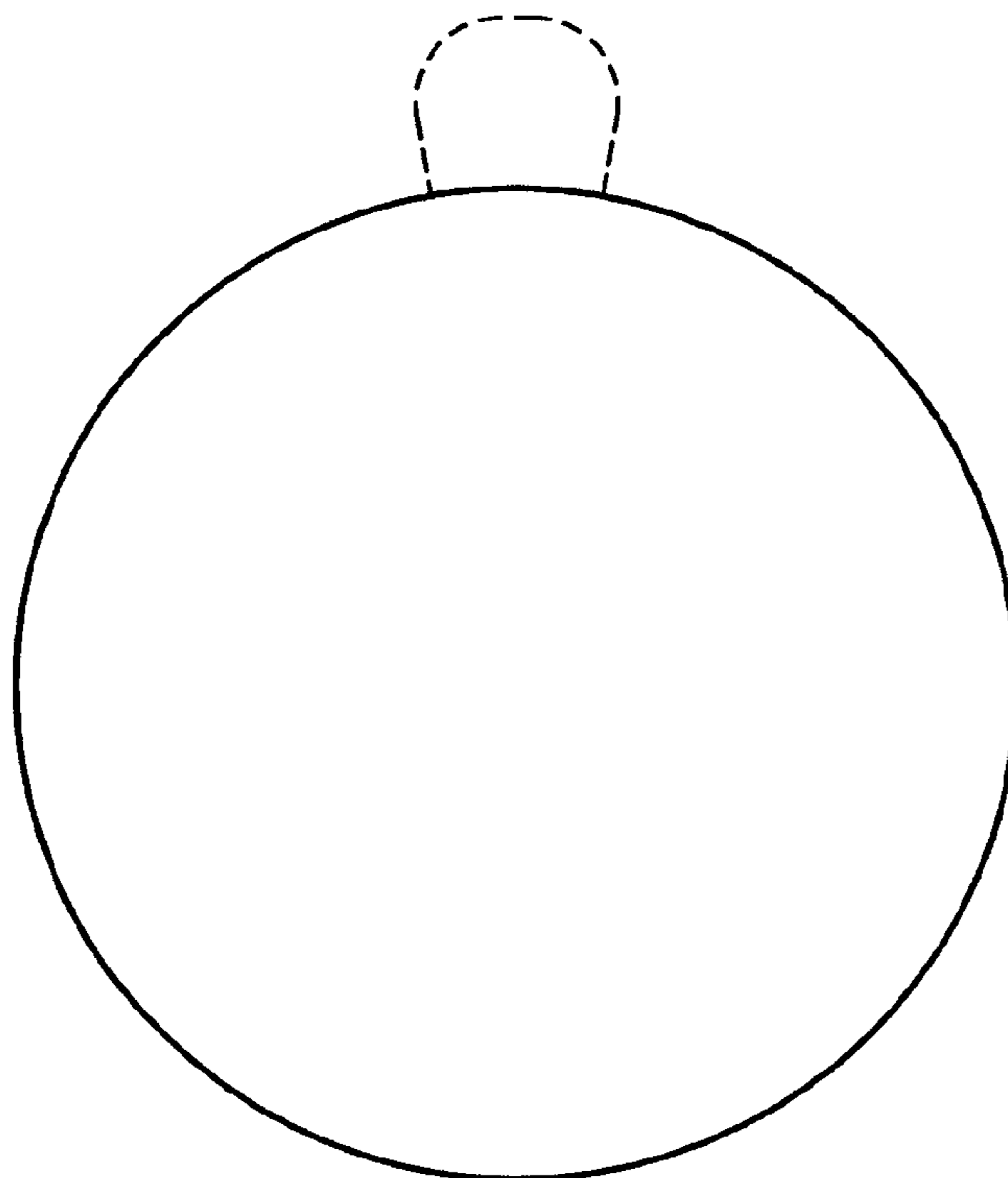

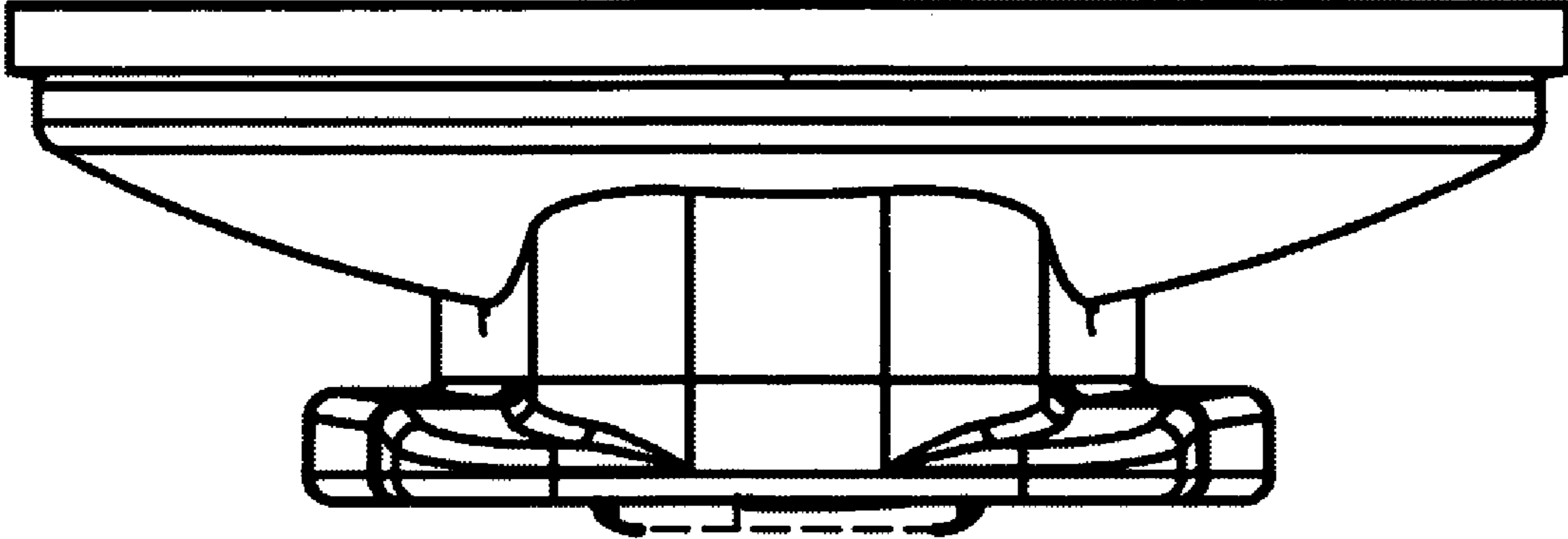

FIGURE 1

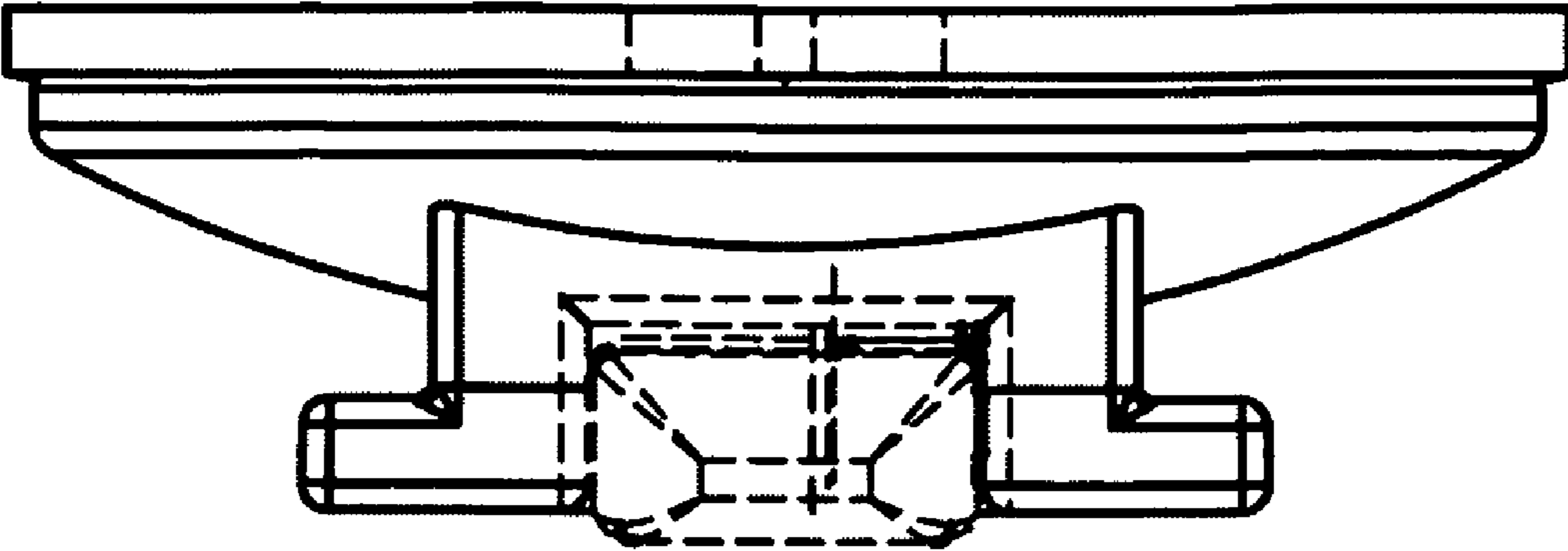

FIGURE 2

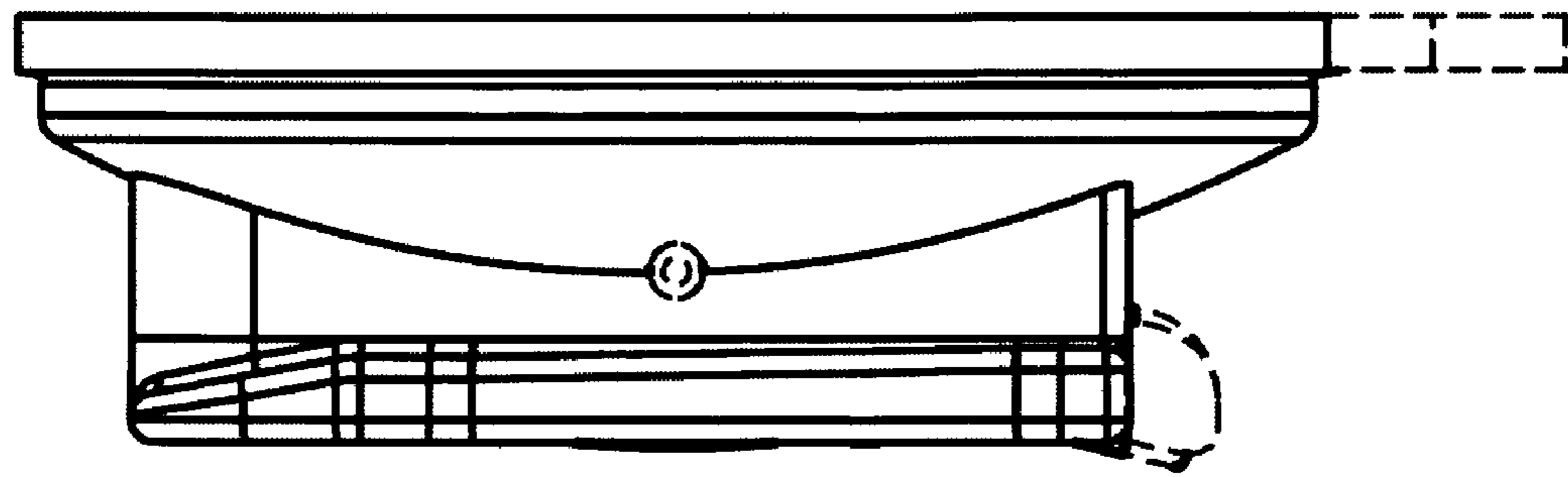

FIGURE 3

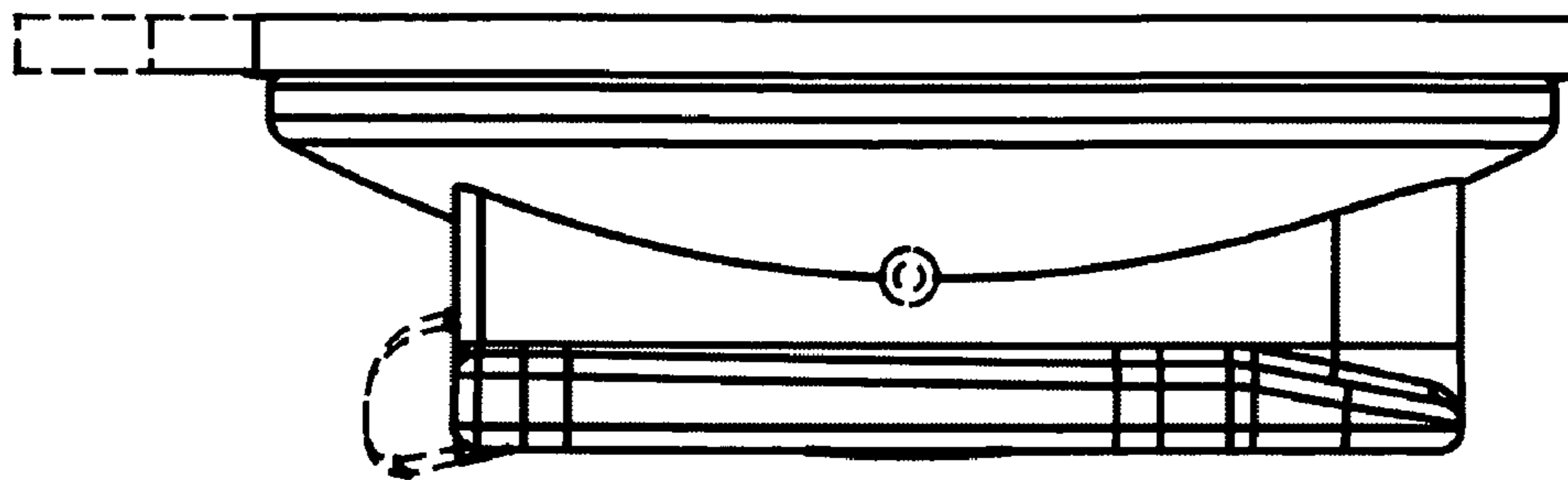

FIGURE 4

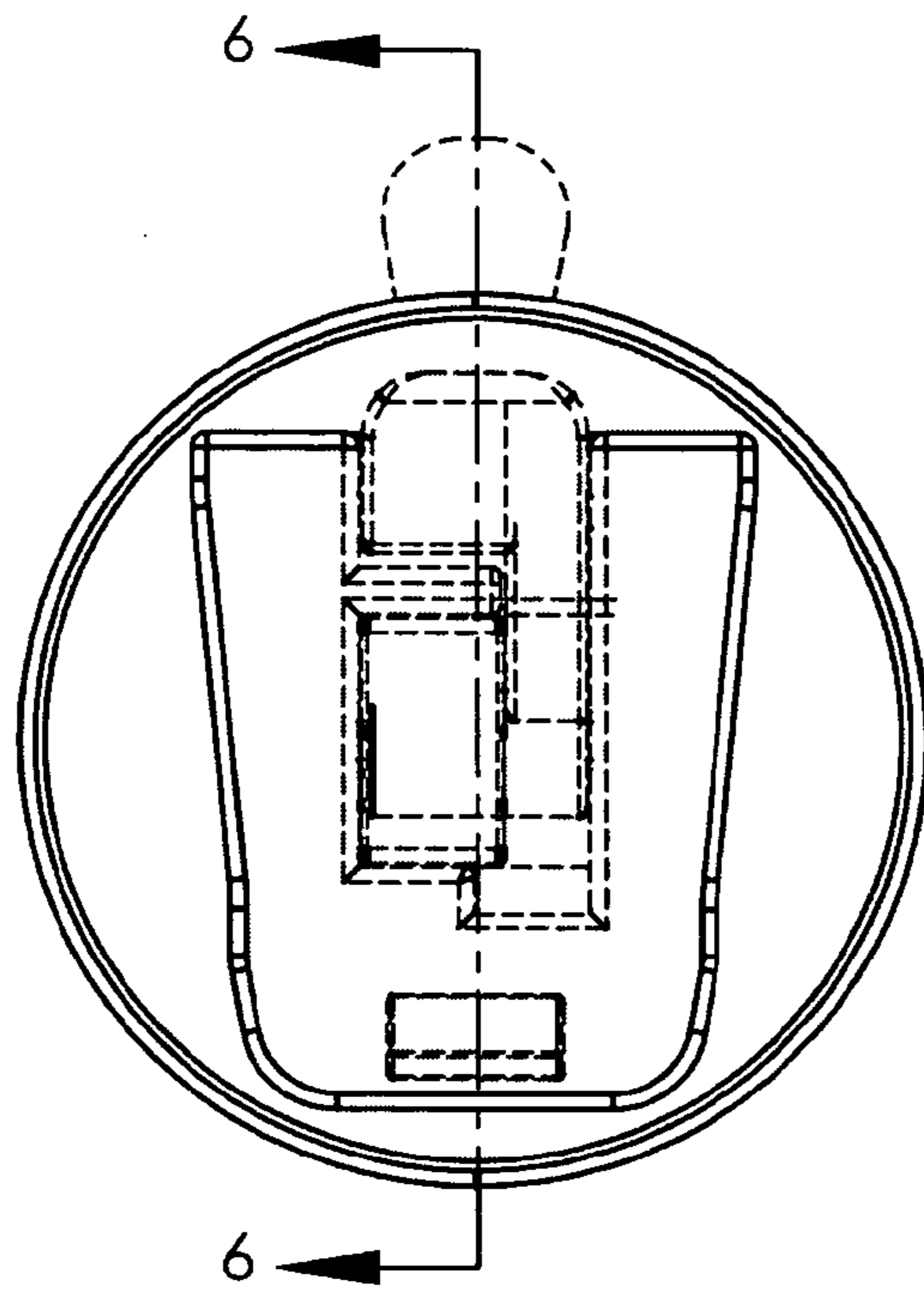

FIGURE 5

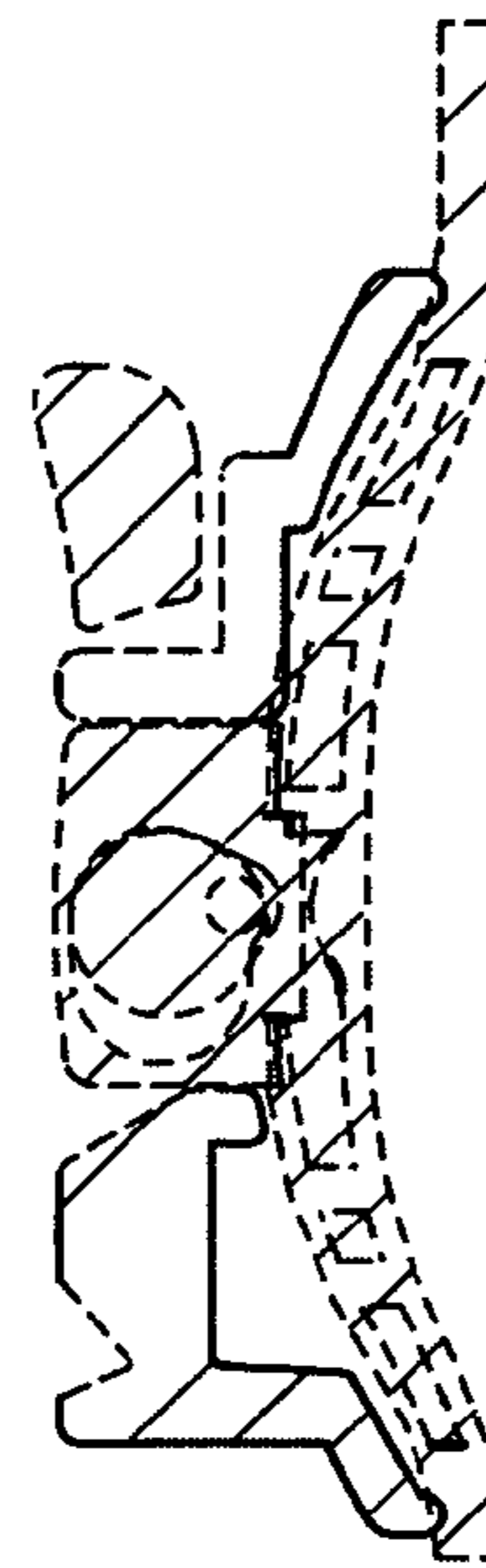
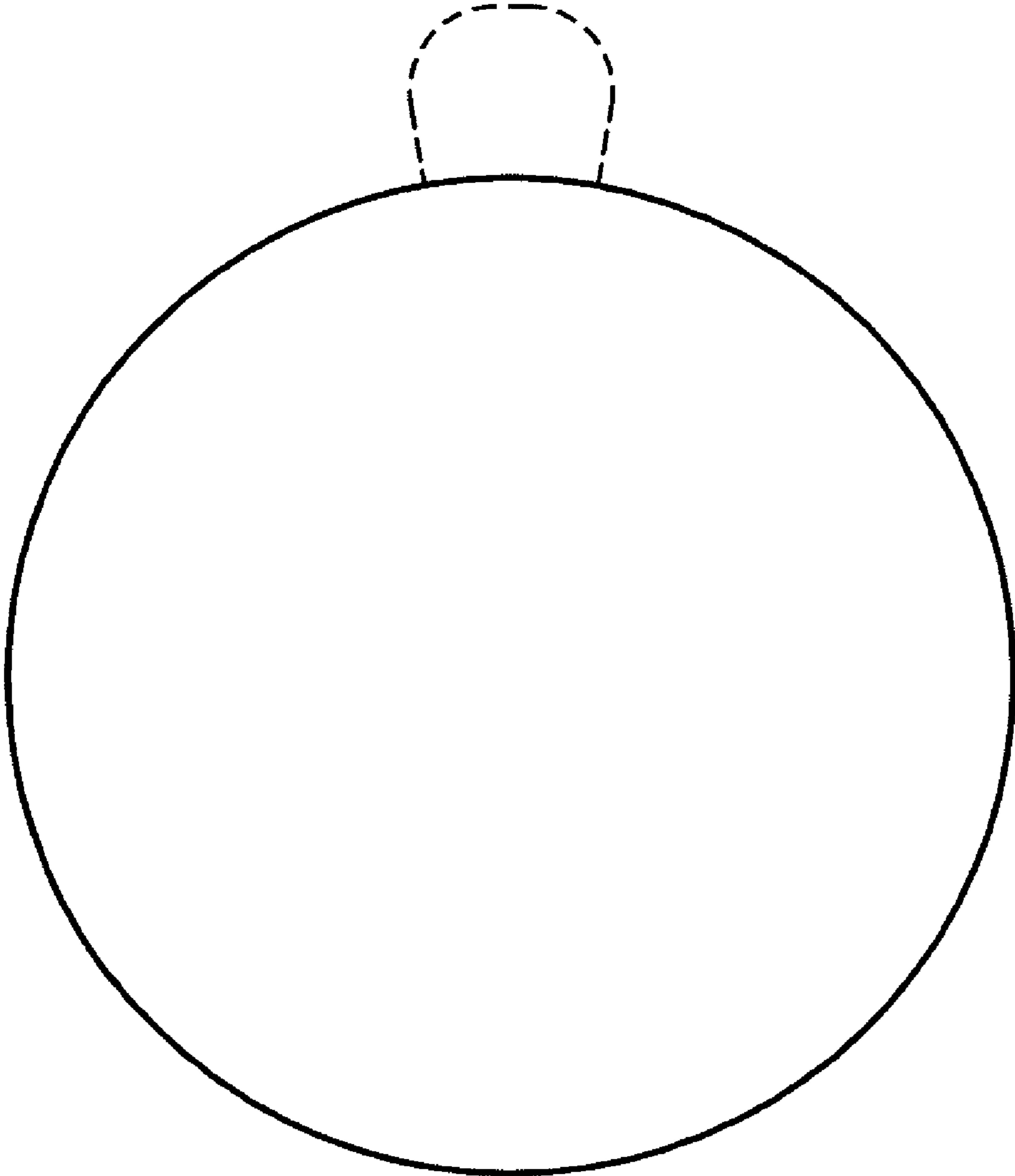

FIGURE 6



**FIGURE 7**

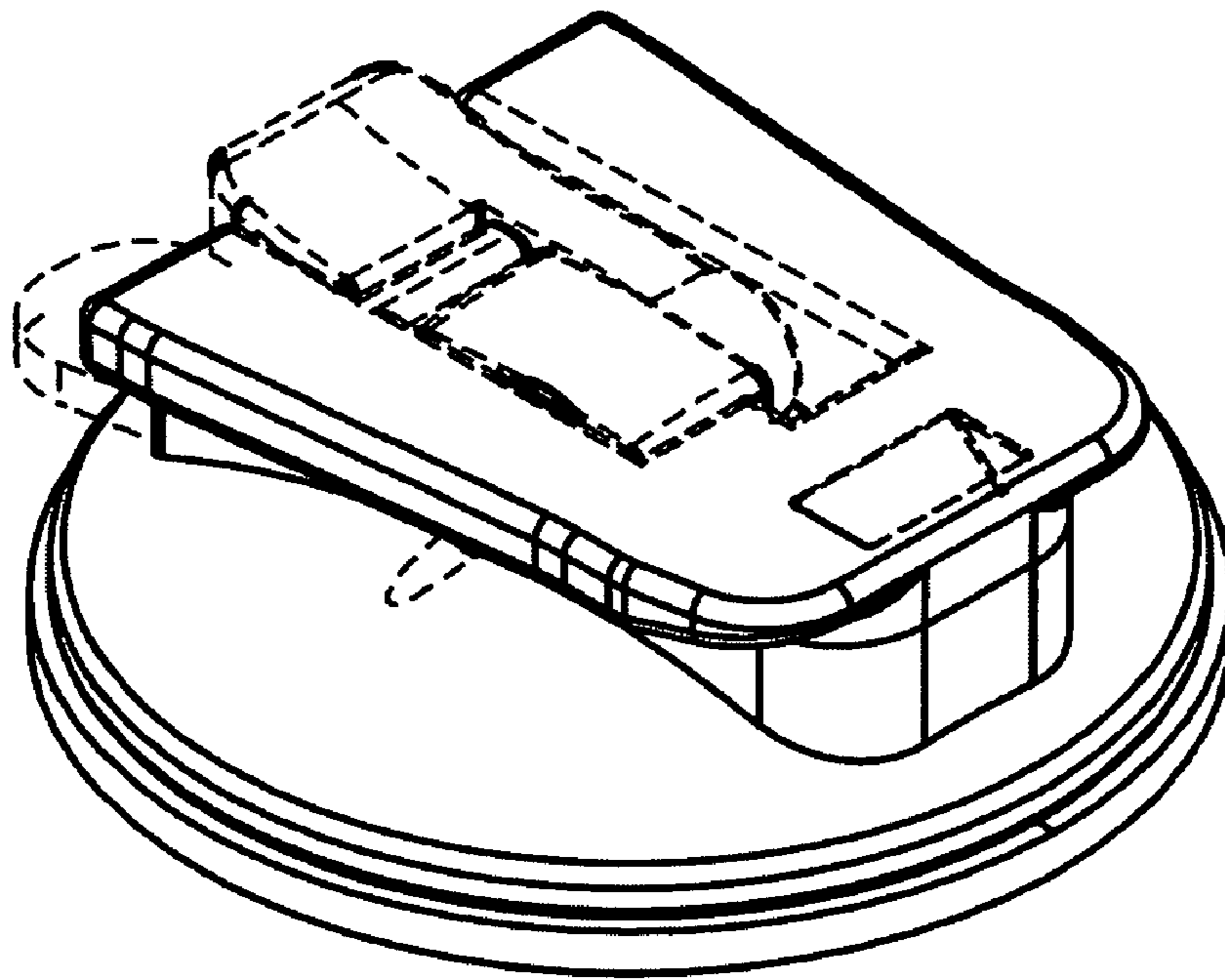

FIGURE 8