



US00D589294S

(12) **United States Design Patent**  
**Averty**

(10) **Patent No.:** **US D589,294 S**

(45) **Date of Patent:** **\*\* \*Mar. 31, 2009**

(54) **WAFFLE IRON**

(75) Inventor: **Lionel Averty**, Dijon (FR)

(73) Assignee: **Tefal**, Rumilly (FR)

(\*) Notice: This patent is subject to a terminal disclaimer.

(\*\*) Term: **14 Years**

(21) Appl. No.: **29/302,702**

(22) Filed: **Jan. 23, 2008**

(30) **Foreign Application Priority Data**

Jul. 23, 2007 (FR) ..... 07 3414

(51) **LOC (9) Cl.** ..... **07-02**

(52) **U.S. Cl.** ..... **D7/356**

(58) **Field of Classification Search** ..... D3/298;  
D7/323, 328-332, 334-341, 347-349, 352-363,  
D7/609; 99/219, 331, 339-340, 349, 369,  
99/372-375, 385-386, 389, 425, 444, 446,  
99/466, 601, 618, 620; 219/524-525, 620-622,  
219/732-734

See application file for complete search history.

(56) **References Cited**

**U.S. PATENT DOCUMENTS**

- D367,994 S \* 3/1996 Bloom et al. .... D7/352
- D411,937 S \* 7/1999 Siegler et al. .... D7/352
- D413,759 S \* 9/1999 Carrere ..... D7/352
- D439,796 S \* 4/2001 Edwards et al. .... D7/352
- D452,411 S \* 12/2001 Gruaz ..... D7/352
- D507,929 S \* 8/2005 Steinberg et al. .... D7/352
- D527,941 S \* 9/2006 Serra ..... D7/352
- D539,074 S \* 3/2007 Lubowicki ..... D7/352
- D541,582 S \* 5/2007 Chuang et al. .... D7/352
- D546,619 S \* 7/2007 McHutchison ..... D7/352

D571,143 S \* 6/2008 He ..... D7/352

**FOREIGN PATENT DOCUMENTS**

WO WO 2005002407 A1 \* 1/2005

\* cited by examiner

*Primary Examiner*—Joel Sincavage

*Assistant Examiner*—Ricky Pham

(74) *Attorney, Agent, or Firm*—Young & Thompson

(57) **CLAIM**

The ornamental design for a waffle iron, as shown and described.

**DESCRIPTION**

FIG. 1 is a top, front and side perspective view of a waffle iron showing my new design, in the open position;

FIG. 2 is a view similar to FIG. 1 but in the closed position;

FIG. 3 is a top plan view thereof in the open position;

FIG. 4 is a top plan view thereof in the closed position;

FIG. 5 is a bottom plan view thereof in the open position;

FIG. 6 is a bottom plan view thereof in the closed position;

FIG. 7 is front elevational view thereof in the open position;

FIG. 8 is a front elevational view thereof in the closed position;

FIG. 9 is a side elevational view thereof from the right of FIG. 7, the side elevational view from the left of

FIG. 7 being the mirror image thereof;

FIG. 10 is a side elevational view thereof from the right of FIG. 8, the side elevational view from the side opposite that shown in FIG. 10 being one mirror image thereof;

FIG. 11 is a rear elevational view thereof in the open position; and,

FIG. 12 is a rear elevational view thereof in the closed position.

**1 Claim, 12 Drawing Sheets**

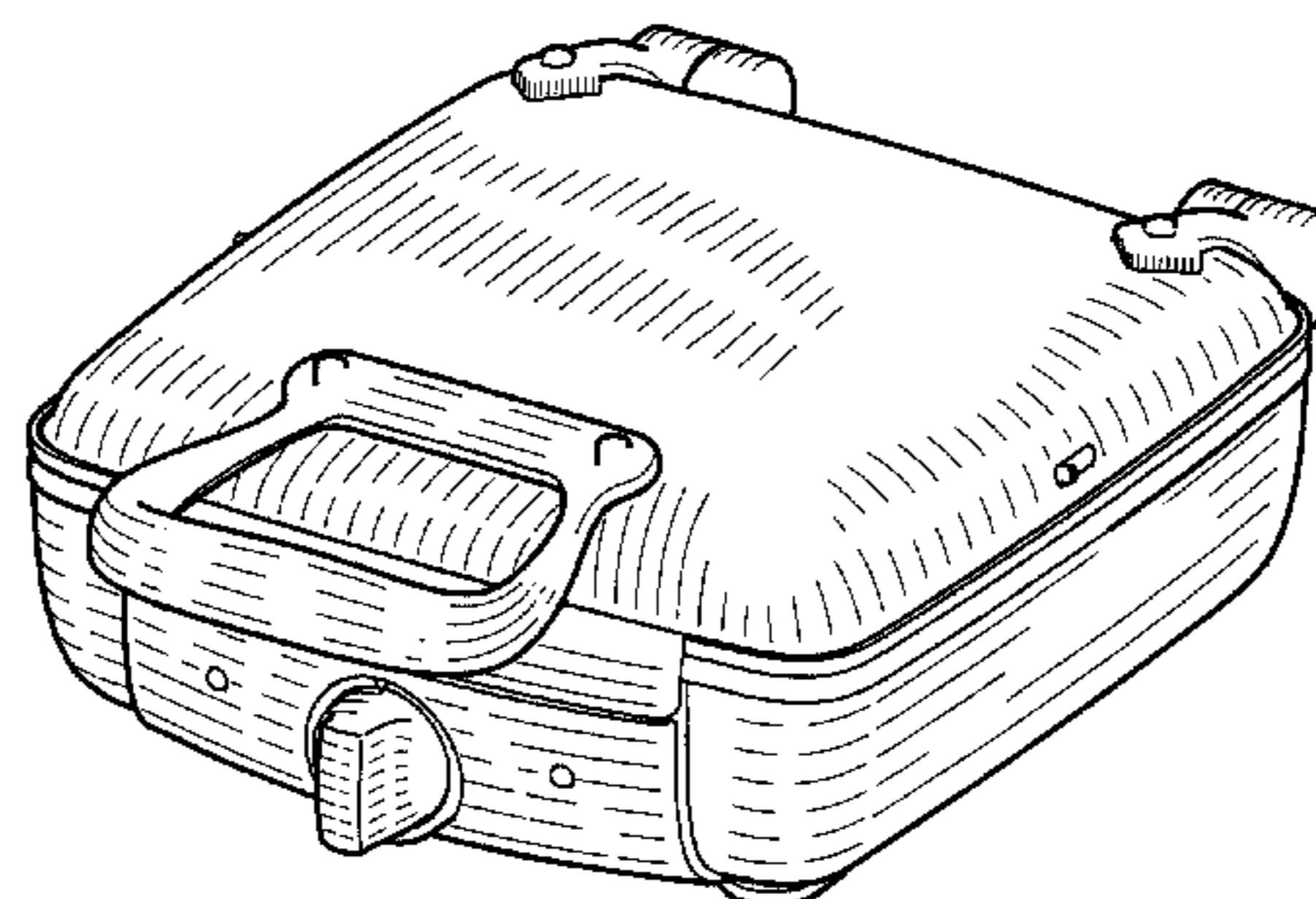
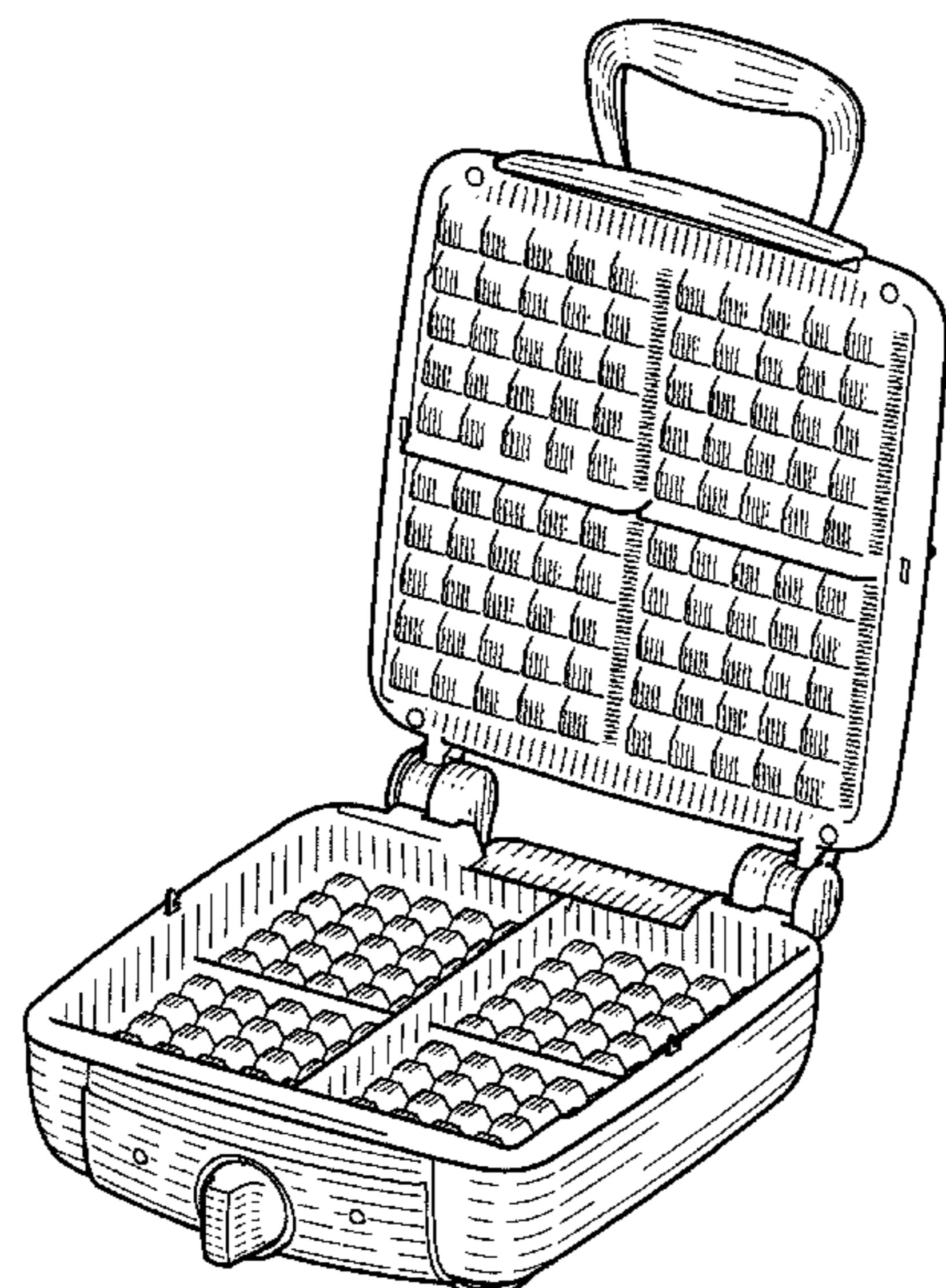

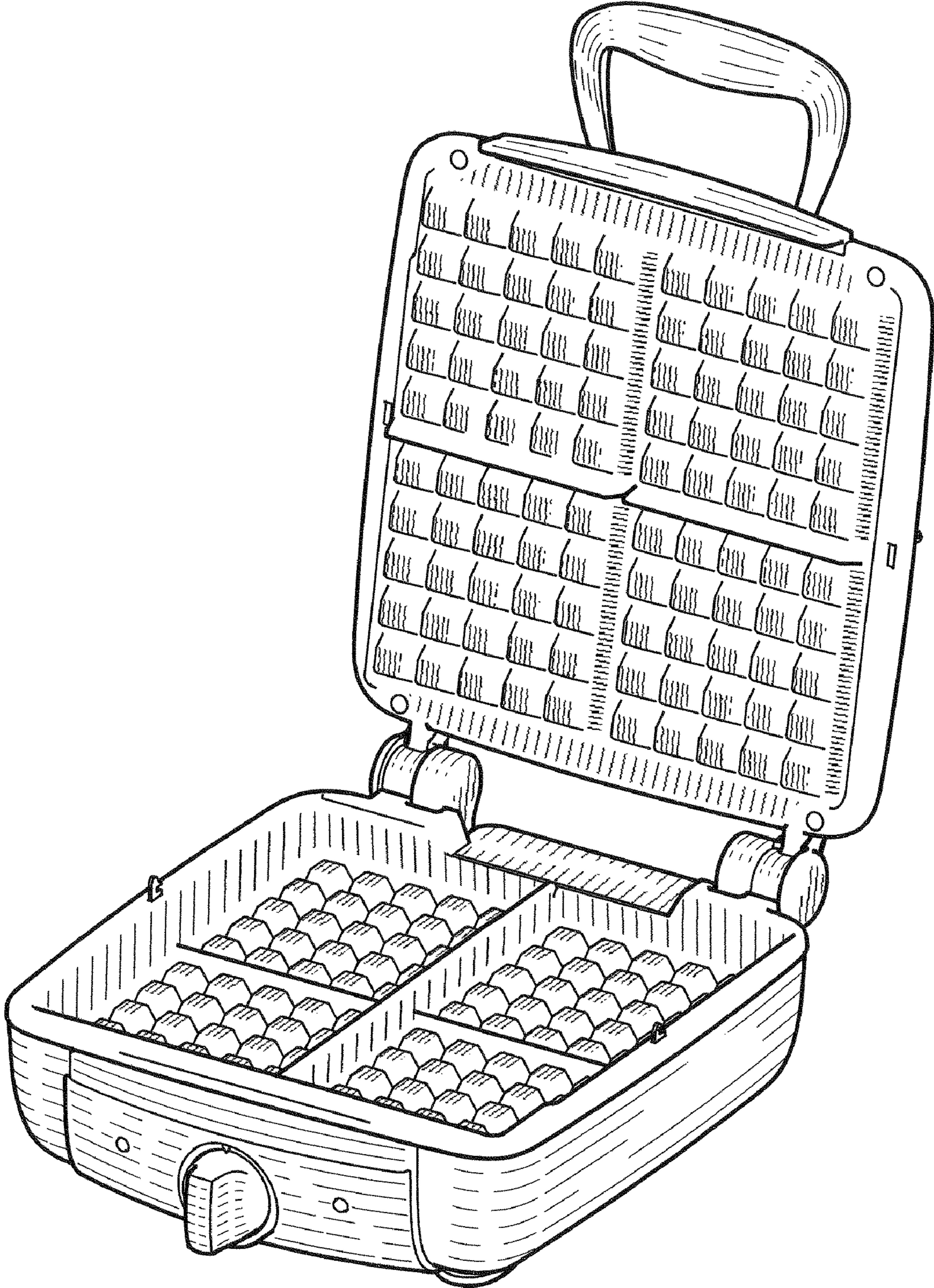

Fig. 1

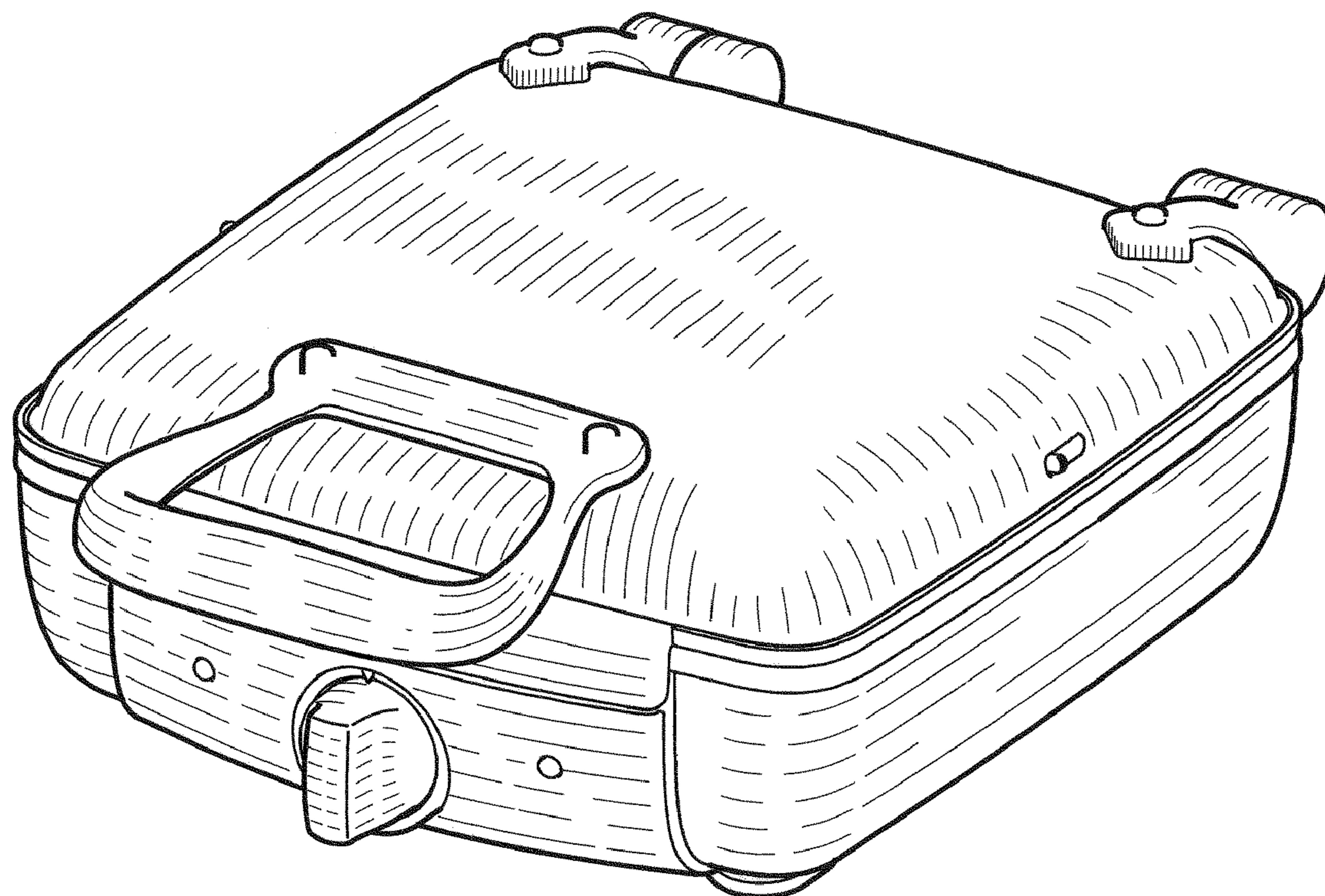

Fig. 2

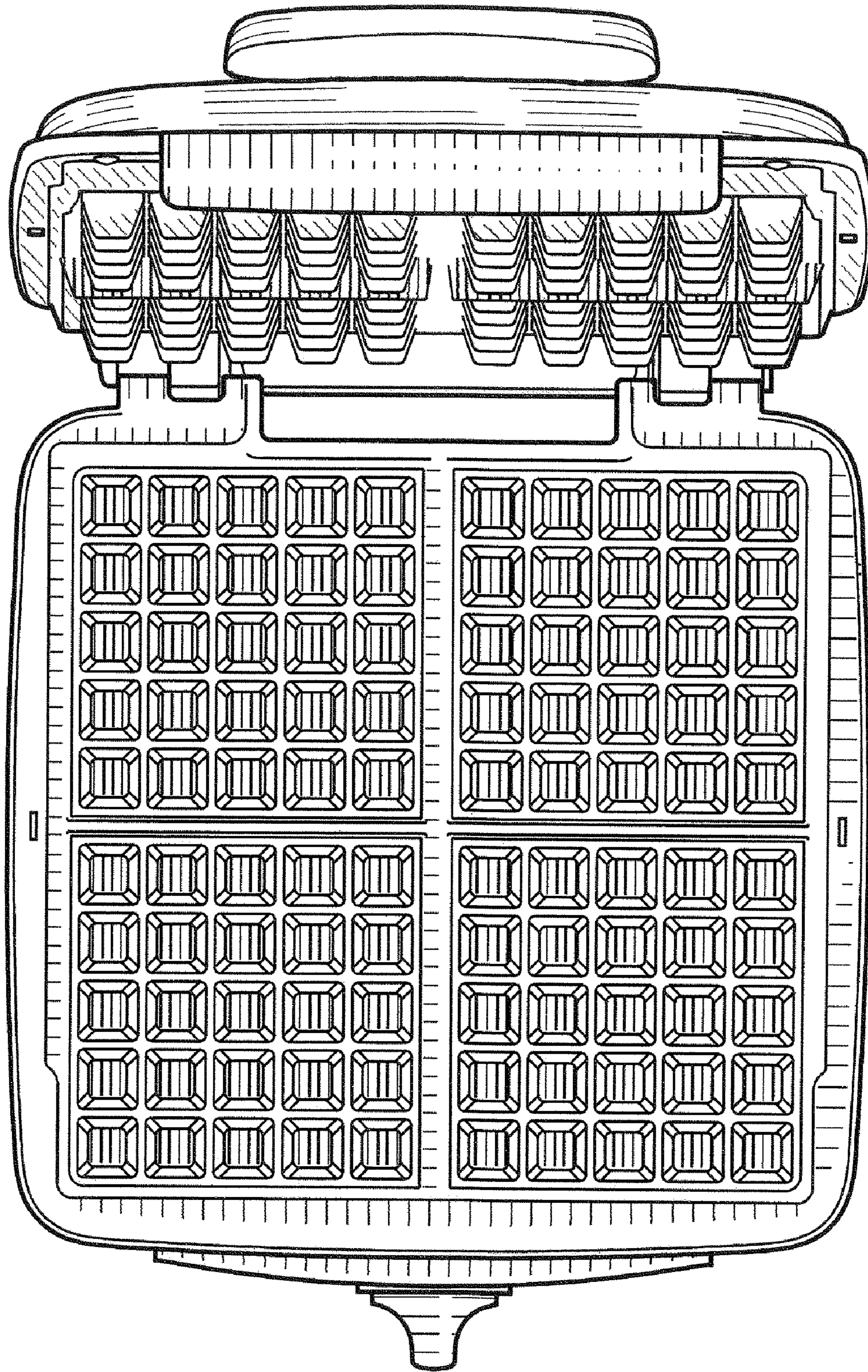

Fig. 3

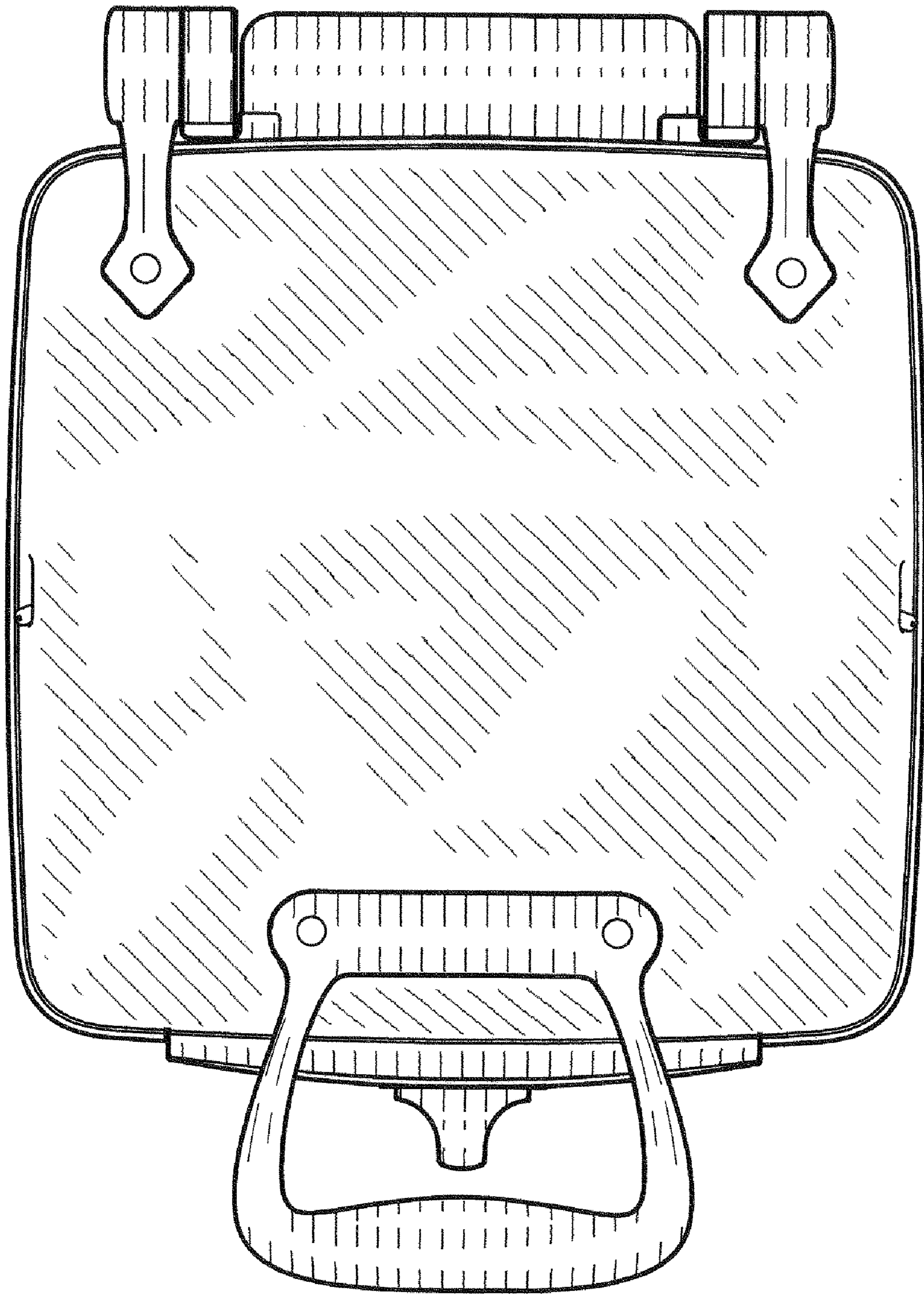

Fig. 4

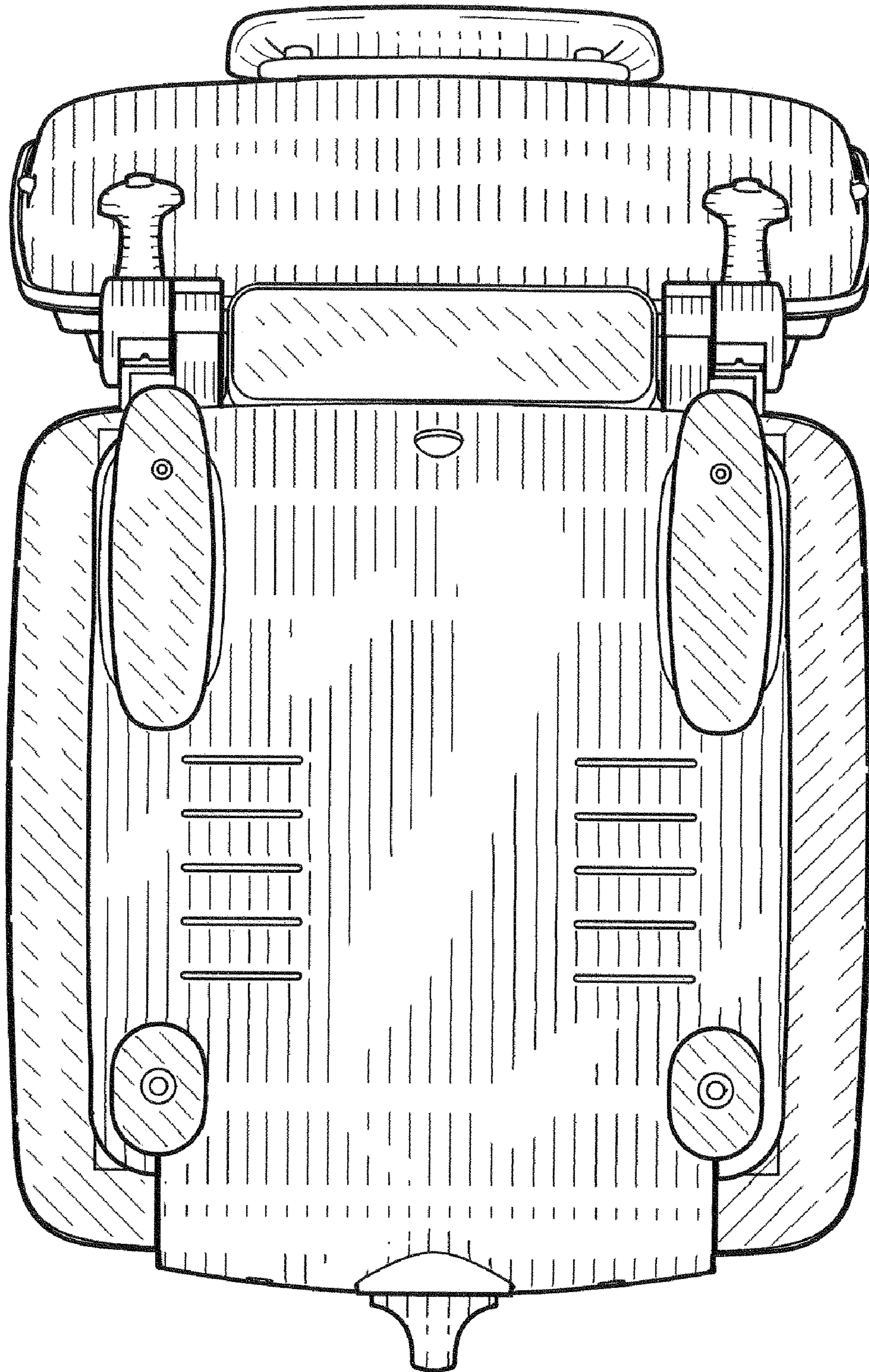

Fig. 5

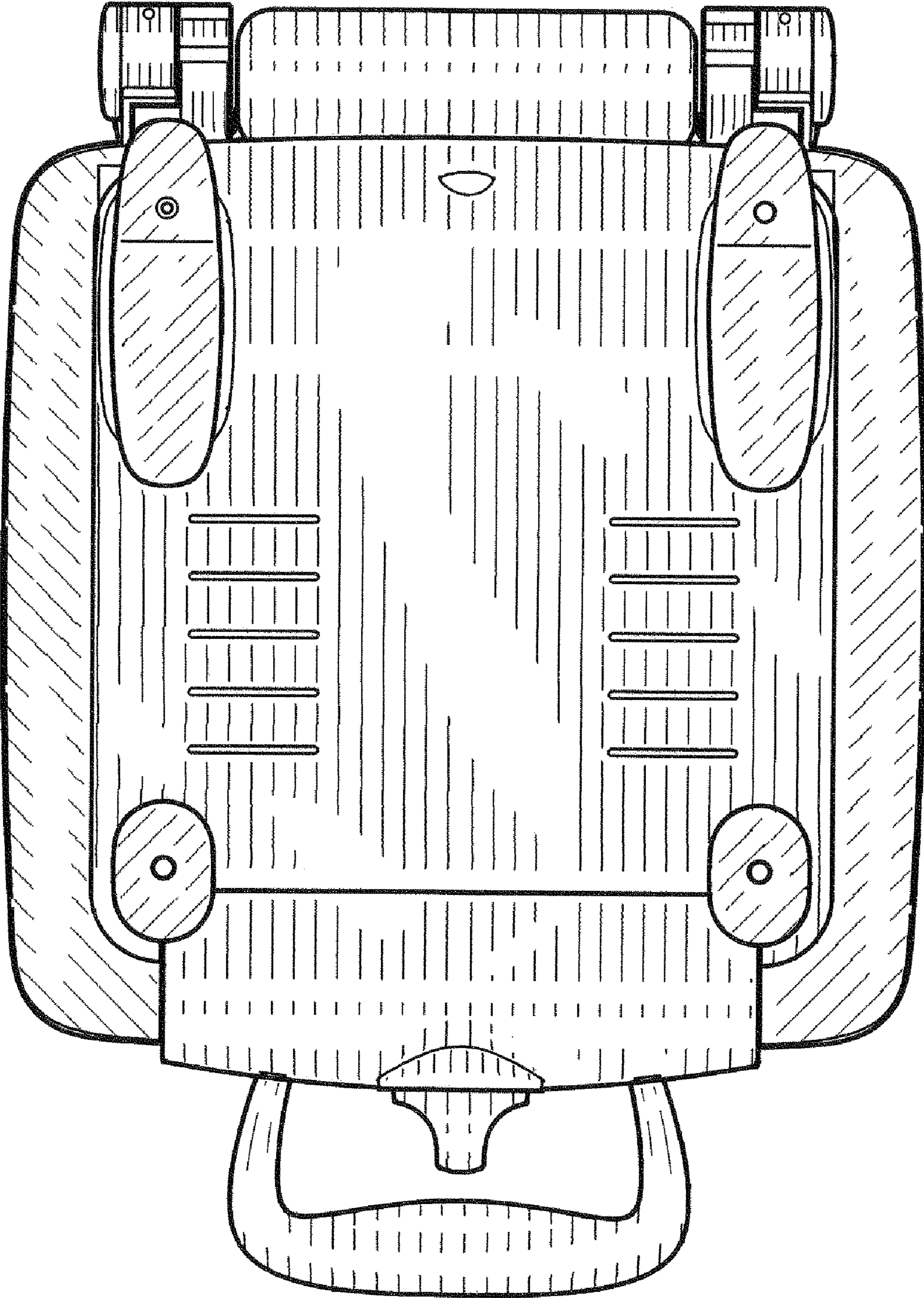

Fig. 6

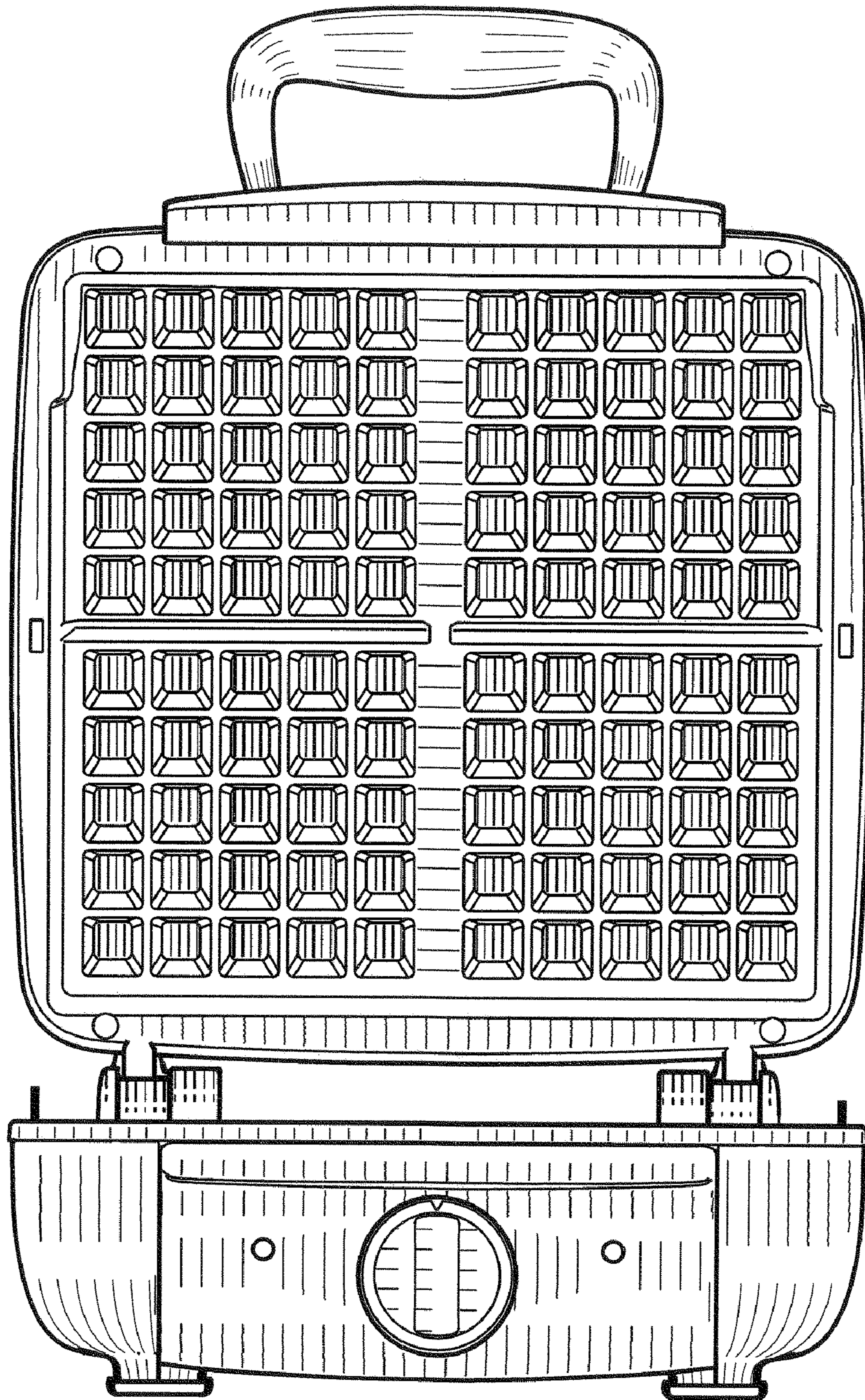

Fig. 7



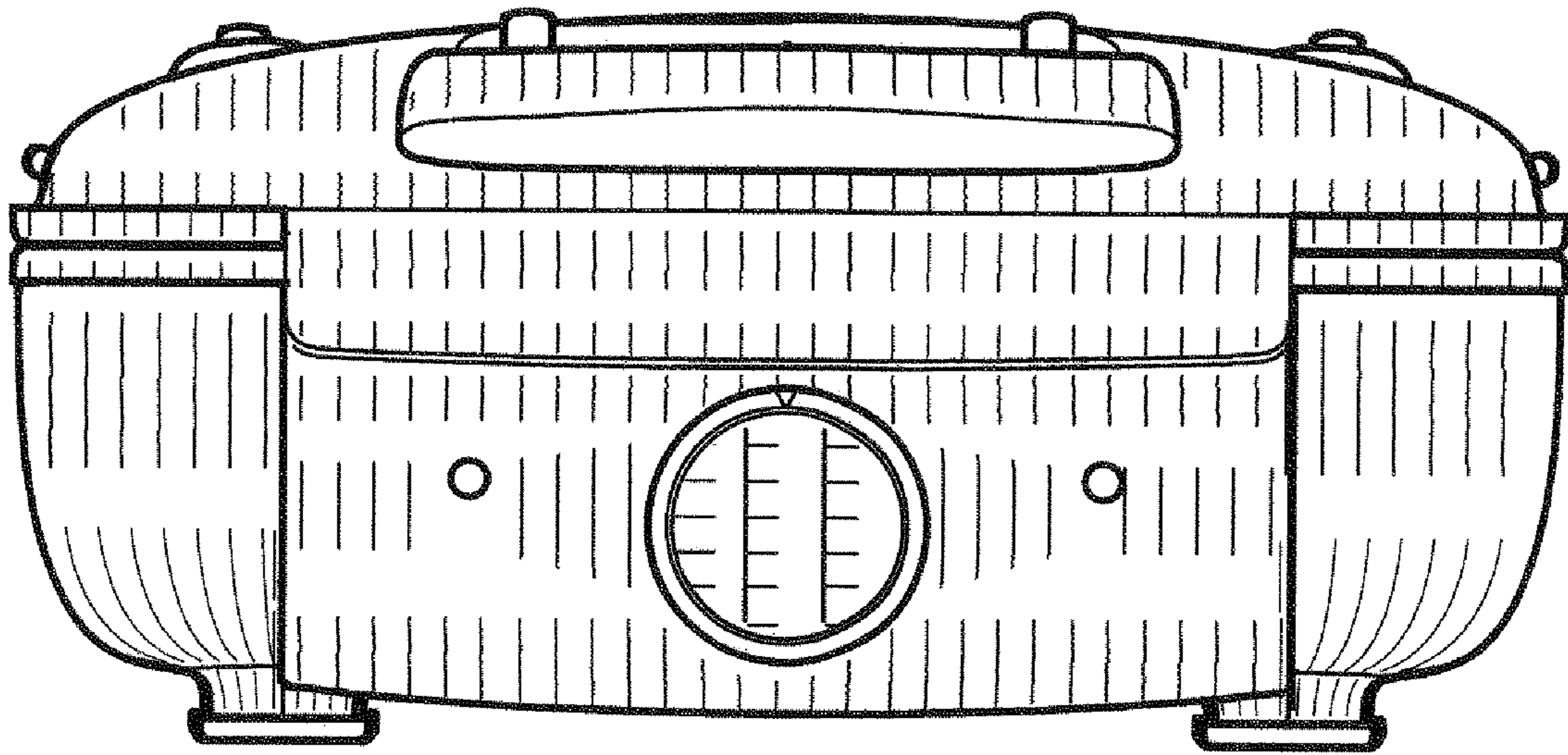

Fig. 8

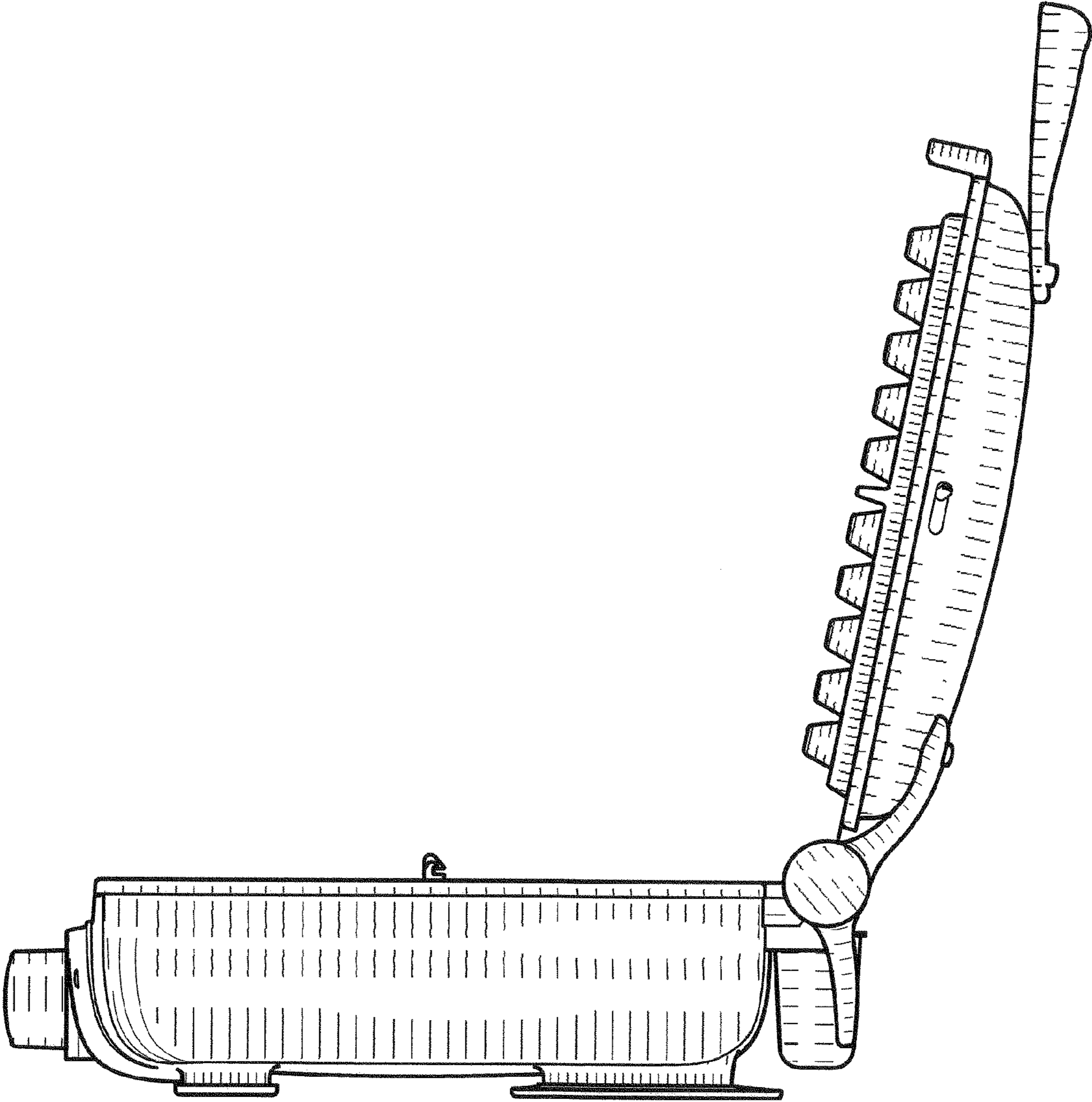

Fig. 9

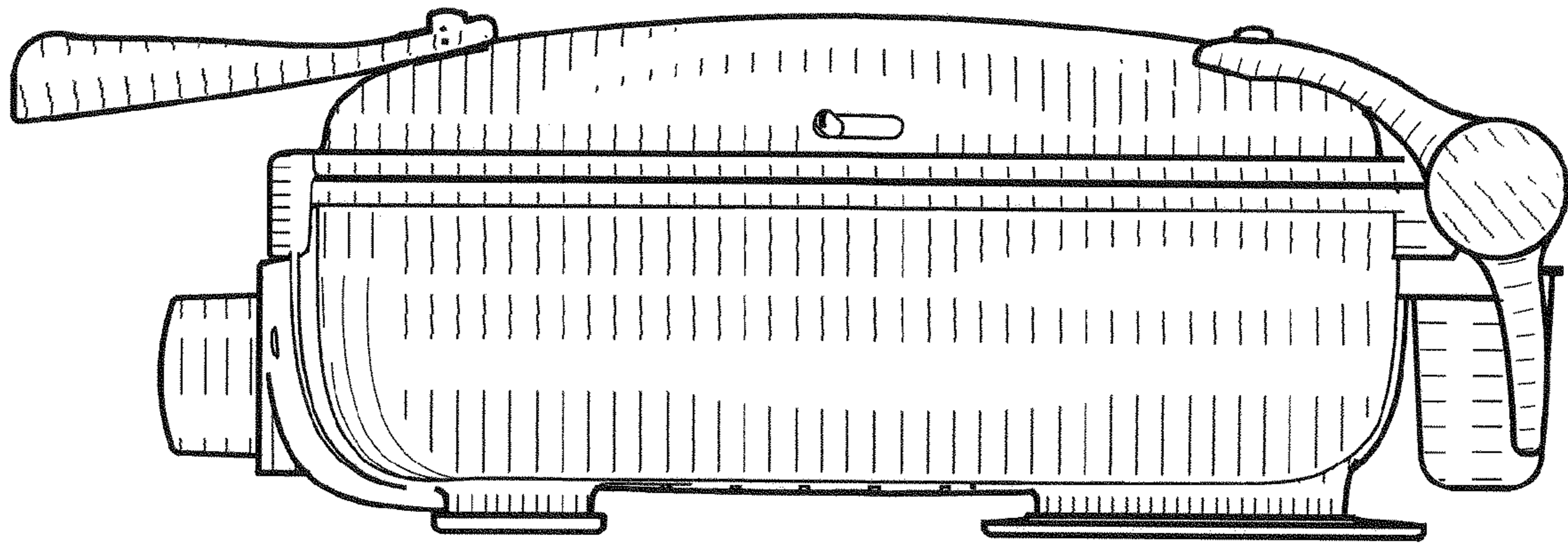

Fig. 10

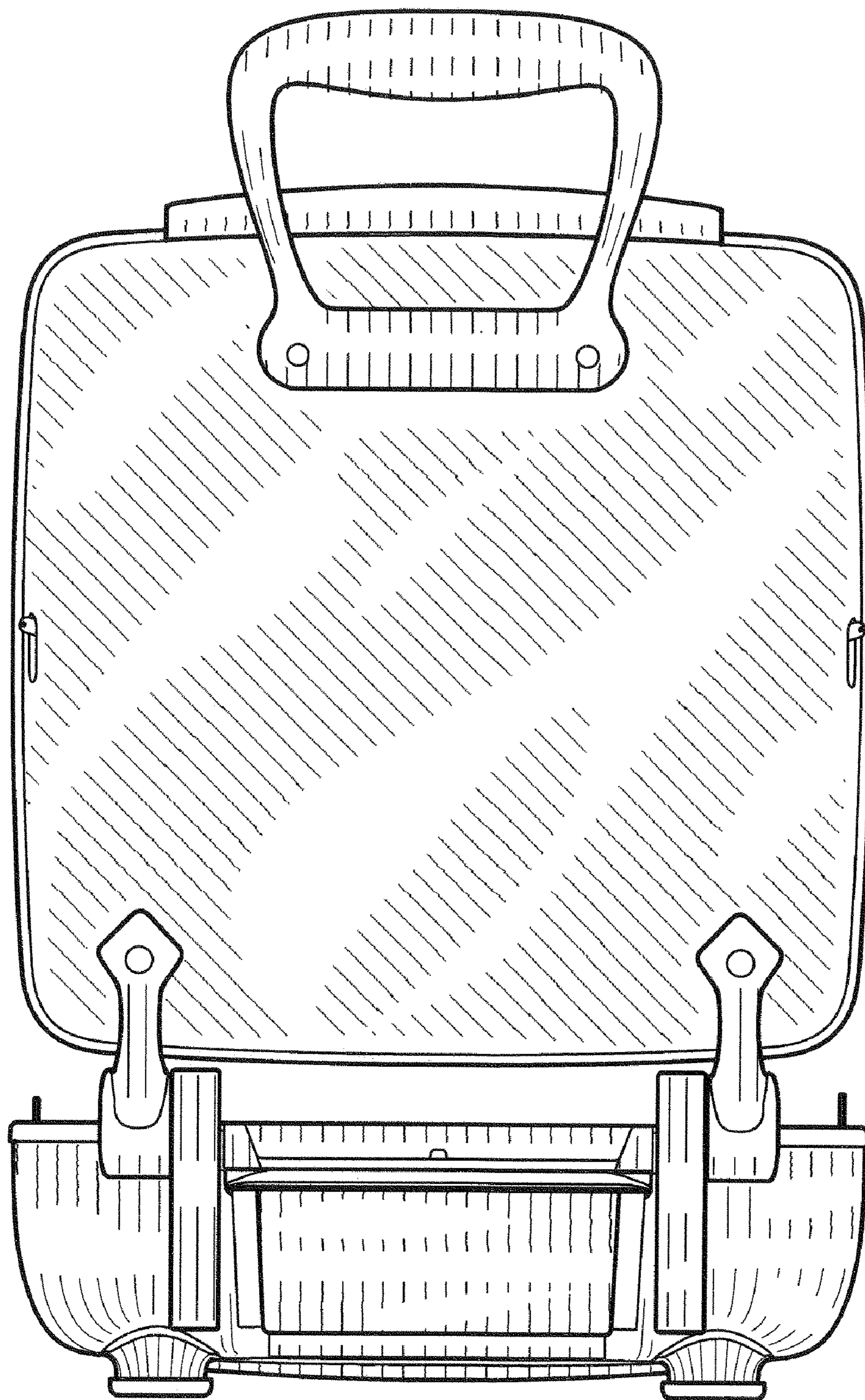

Fig. 11

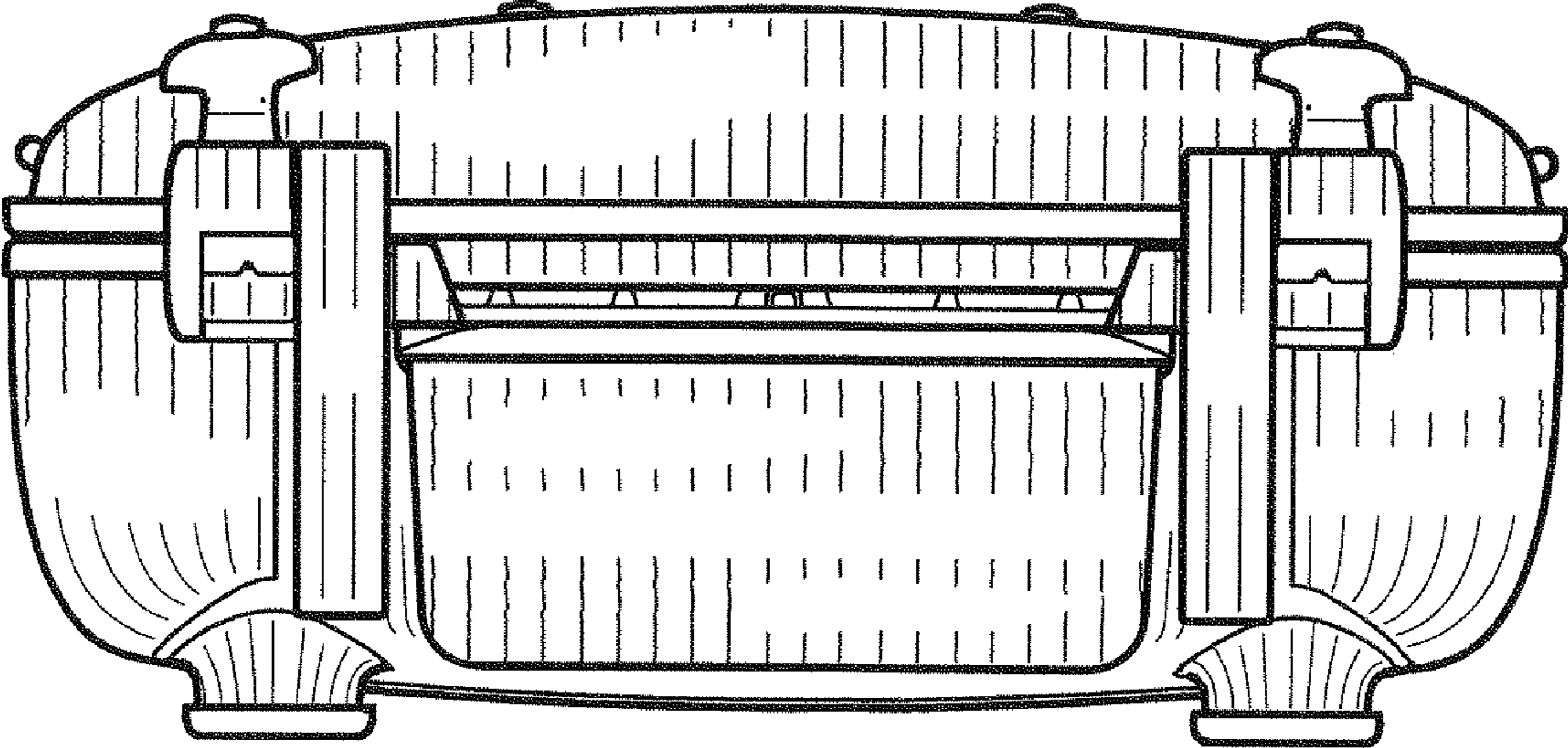

Fig. 12