



US00D589287S

(12) **United States Design Patent**
Welsch et al.

(10) **Patent No.:** **US D589,287 S**
(45) **Date of Patent:** **** Mar. 31, 2009**

(54) **MERCHANDISING SHELF WITH A RAISED MAT**

(75) Inventors: **John H. Welsch**, Roaring Brook Township, PA (US); **Douglas C. Bates**, Mountaintop, PA (US); **Alan R. Grula**, Wilkes-Barre, PA (US); **Frank J. Hilstolsky**, Dallas, PA (US); **Daniel L. Sarge**, Berwick, PA (US)

(73) Assignee: **Metro Industries Inc.**, Reno, NV (US)

(**) Term: **14 Years**

(21) Appl. No.: **29/300,372**

(22) Filed: **Mar. 20, 2008**

(51) **LOC (9) Cl.** **06-06**

(52) **U.S. Cl.** **D6/511**

(58) **Field of Classification Search** D6/407,
D6/628-630, 418, 462-465, 467, 468, 475,
D6/477-479, 511; 211/153, 187, 90.02,
211/40, 41.1, 41.12, 76, 133.2, 133.5, 181.1,
211/180; 108/147.13, 147.14, 193, 147.11,
108/93

See application file for complete search history.

(56) **References Cited**

U.S. PATENT DOCUMENTS

D185,801 S * 8/1959 Maslow D6/511

(Continued)

OTHER PUBLICATIONS

'Shelves, Decks, Shelf Accessories' [online], Lozier Corporation, 2005 [retrieved on Jul. 21, 2008]. Retrieved from the Internet: URL: < <http://www.lozier.com/PDF/200s.pdf> >.

(Continued)

Primary Examiner—Caron Veynar

Assistant Examiner—Sydney R Buffalow

(74) *Attorney, Agent, or Firm*—Fitzpatrick, Cella, Harper & Scinto

(57) **CLAIM**

The design for a merchandising shelf with a raised mat, as shown and described.

DESCRIPTION

FIG. 1 is a perspective view from the front and one side of the merchandising shelf with a raised mat in accordance with the present invention;

FIG. 2 is a top plan view of the merchandising shelf with a raised mat shown in FIG. 1;

FIG. 3 is a rear view of the merchandising shelf with a raised mat shown in FIG. 1;

FIG. 4 is a front view of the merchandising shelf with a raised mat shown in FIG. 1;

FIG. 5 is a right side view of the merchandising shelf with a raised mat shown in FIG. 1;

FIG. 6 is a left side view of the merchandising shelf with a raised mat shown in FIG. 1;

FIG. 7 is a bottom plan view of the merchandising shelf with a raised mat shown in FIG. 1;

FIG. 8 is a perspective view from the front and one side of a second embodiment of the merchandising shelf with a raised mat in accordance with the present invention;

FIG. 9 is a top plan view of the merchandising shelf with a raised mat shown in FIG. 8;

FIG. 10 is a rear view of the merchandising shelf with a raised mat shown in FIG. 8; and

FIG. 11 is a left side view of the merchandising shelf with a raised mat shown in FIG. 8;

FIG. 12 is a front view of the merchandising shelf with a raised mat shown in FIG. 8;

FIG. 13 is a right side view of the merchandising shelf with a raised mat shown in FIG. 8; and,

FIG. 14 is a bottom plan view of the merchandising shelf with a raised mat shown in FIG. 8.

1 Claim, 8 Drawing Sheets

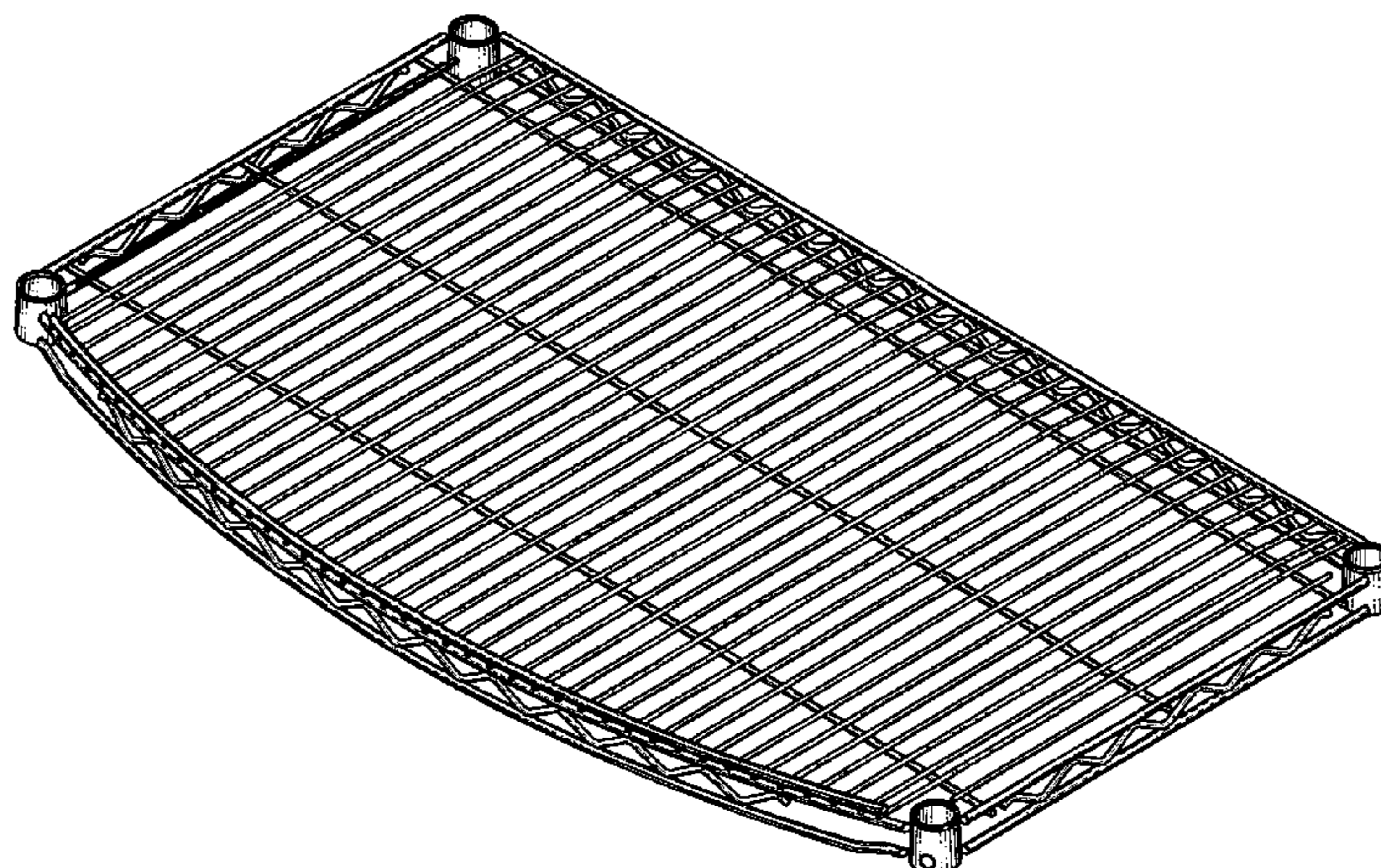

U.S. PATENT DOCUMENTS

D215,773	S *	10/1969	Maslow	D6/462
3,523,508	A *	8/1970	Maslow	108/147.13
3,964,404	A *	6/1976	Mueller et al.	108/147.14
D289,479	S *	4/1987	Brancher	D6/511
D326,579	S *	6/1992	Leeds	D6/511
5,390,803	A *	2/1995	McAllister	211/153
5,415,302	A *	5/1995	Carlson et al.	211/187
5,601,038	A *	2/1997	Welch et al.	108/193
5,924,581	A *	7/1999	Chen	211/187
6,015,052	A *	1/2000	Goldberg et al.	211/187
6,158,600	A *	12/2000	Ferrucci et al.	211/90.02
6,364,139	B1 *	4/2002	Chen	211/187
6,622,876	B2 *	9/2003	Goldberg	211/181.1
D489,205	S *	5/2004	Droppers et al.	D6/511
6,905,037	B1 *	6/2005	Goldberg	211/181.1
7,040,494	B2 *	5/2006	Harper	211/90.02

OTHER PUBLICATIONS

'Assembly Instructions' [online], InterMetro Industries Corporation, Apr. 2006 [retrieved on Jul. 21, 2008]. Retrieved from the Internet: URL: < http://www.metro.com/literature_getPDF.cfm/id/314 >.

'Super Erecta qwikSLOT Shelving' [online], InterMetro Industries Corporation, 2000 [retrieved on Jul. 21, 2008]. Retrieved from the Internet: URL: < http://www.metro.com/literature_getPDF.cfm/id/122 >.

'Metro Commercial Catalog' [online], InterMetro Industries Corporation, 2008 [retrieved on Jul. 21, 2008]. Retrieved from the Internet: URL: < http://www.metro.com/commercial/catalog_2008/ >. pp. 21, 23, and 118.

'HALFRAD2_WEB.jpg Product Image—HALFRAD2 .jpg' [online], Madix Store Fixtures, Apr. 25, 2008 [retrieved on Jul. 21,

2008]. Retrieved from the Internet: URL: <<http://www.madixinc.com/esales/start>.

swe?SWEView=Home+Page+View+%28eSales%29

&SWECmd=GotoView&SWEBOK=1 >.

'HalfRad-Lumiback_WEB.jpg, Product Image—HalfRad .jpg' [online], Madix Store Fixtures, Apr. 25, 2008 [retrieved on Jul. 21, 2008]. Retrieved from the Internet: URL: < <http://www.madixinc.com/esales/start>.

swe?SWEView=Home+Page+View+%28eSales%29

&SWECmd=GotoView&SWEBOK=1 >.

'HalfRad1_WEB.jpg, Product Image—HalfRad .jpg' [online], Madix Store Fixtures, Apr. 25, 2008 [retrieved on Jul. 21, 2008].

Retrieved from the Internet: URL: < <http://www.madixinc.com/esales/start.swe?SWEView=Home+Page+View+%28eSales%29&SWECmd=GotoView&SWEBOK=1> >.

'HalfRadius-WEB.jpg, Product Image—Half Radius .jpg' [online], Madix Store Fixtures, Mar. 26, 2008 [retrieved on Jul. 21, 2008].

Retrieved from the Internet: URL: < <http://www.madixinc.com/esales/start.swe?SWEView=Home+Page+View+%28eSales%29&SWECmd=Go+to+View&SWEBOK=1> >.

'SUSHRF-(NW)(LSD)(RSD)-(MF)-WEB.jbg, Product Image—SUSHRF-(NW)(LSD)(RSD)-(MF)' [online], Madix Store Fixtures, Mar. 26, 2008 [retrieved on Jul. 21, 2008]. Retrieved from the Internet: URL: <http://www.madixinc.com/esales/start.swe?SWEView=Home+Page+View+%28eSales%29&SWECmd=GotoView&SWEBOK=1> >.

Erecta for Professional—Super Type Optional Parts. Erecta International Corporation. Believed to be at least as old at Nov. 5, 2007.

'Erecta for Professional—Super Type Optional Parts' [online], Erecta International Corporation [retrieved on Jul. 22, 2008]. Retrieved from the Internet: URL: < <http://www.erecta.co.jp/pdf/seoptionalparts.pdf> >. p. 57.

* cited by examiner

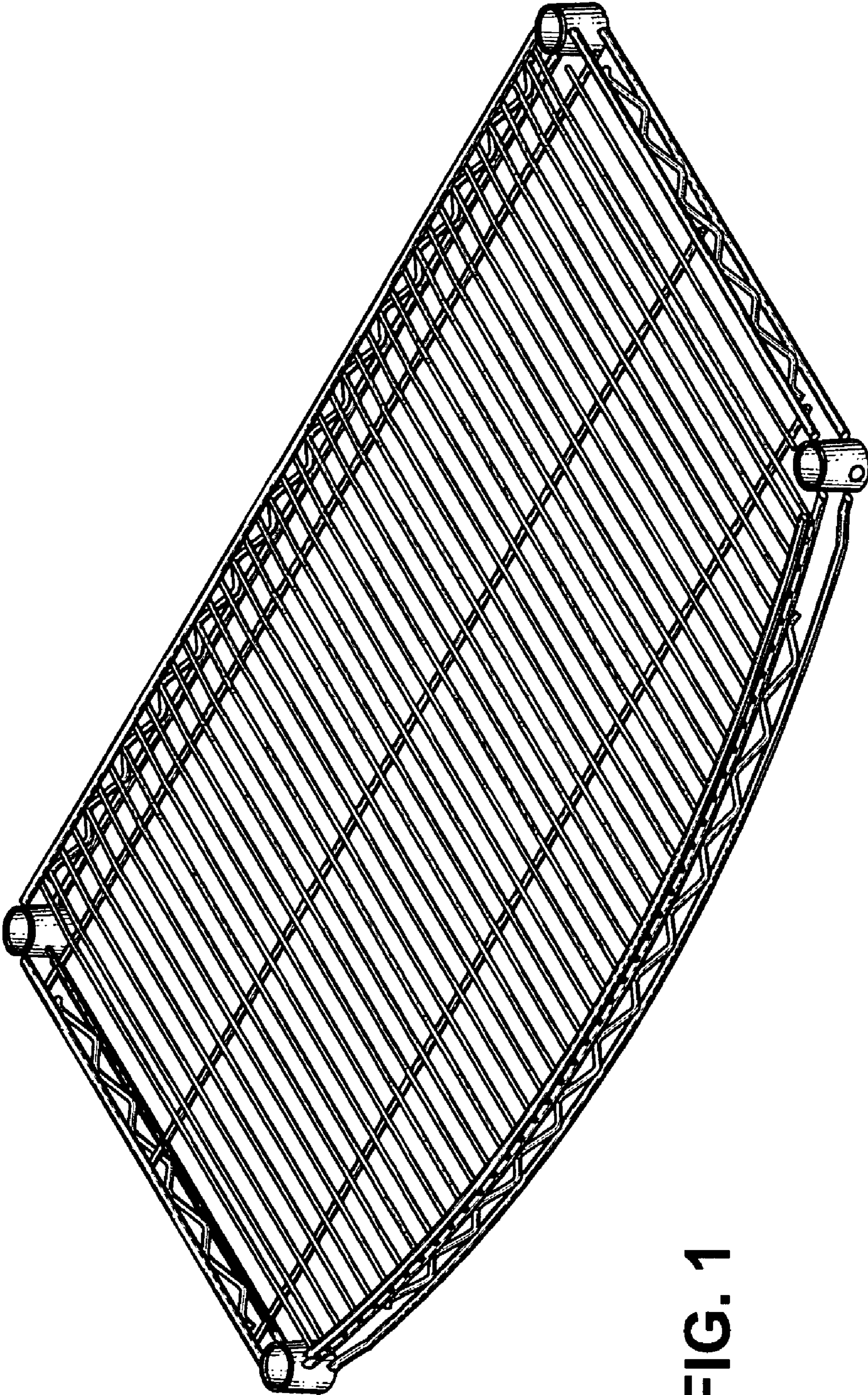

FIG. 1

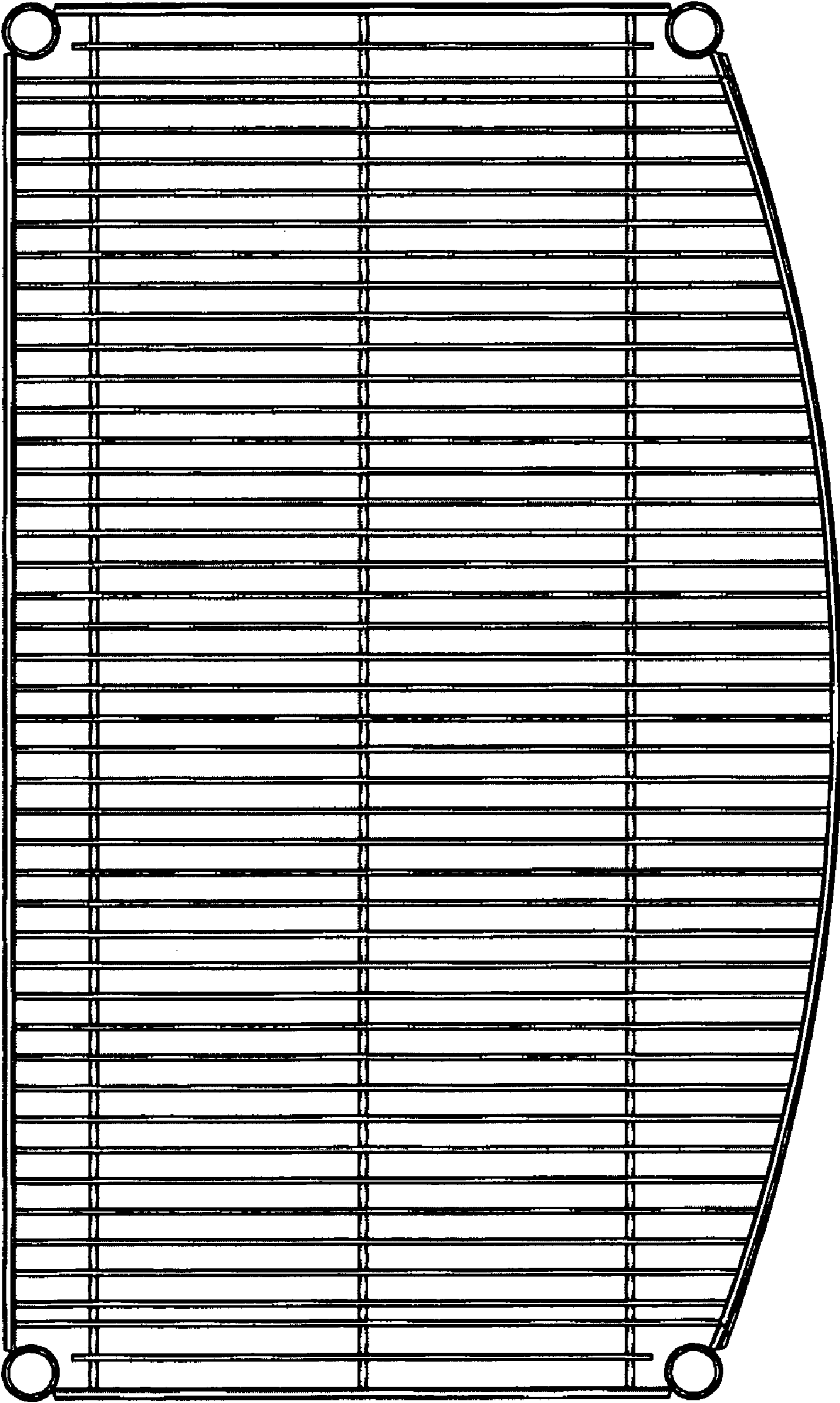

FIG. 2



FIG. 3



FIG. 4

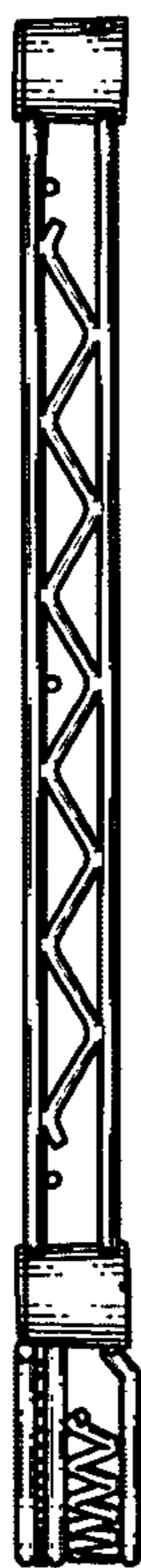

FIG. 5



FIG. 6

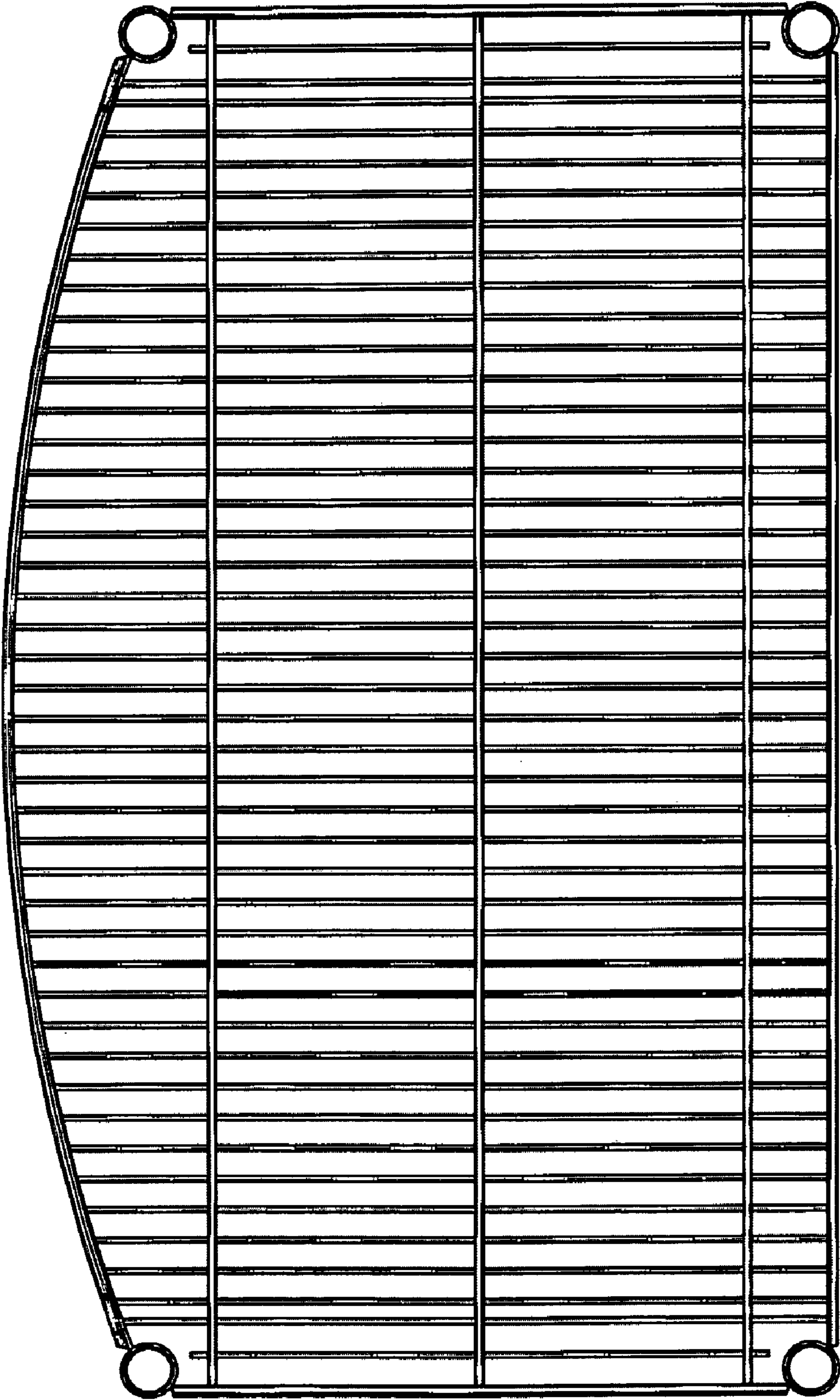

FIG. 7

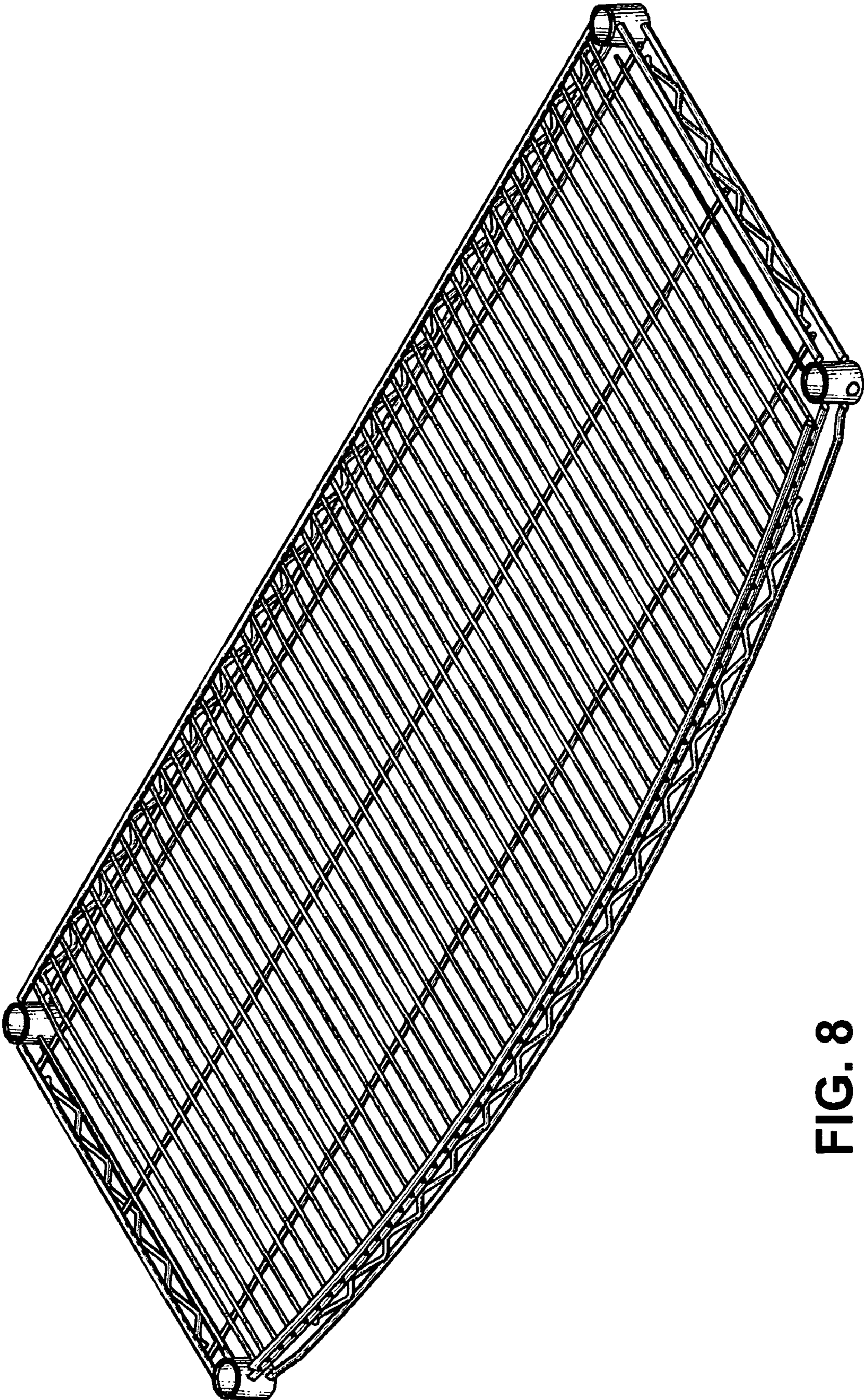

FIG. 8

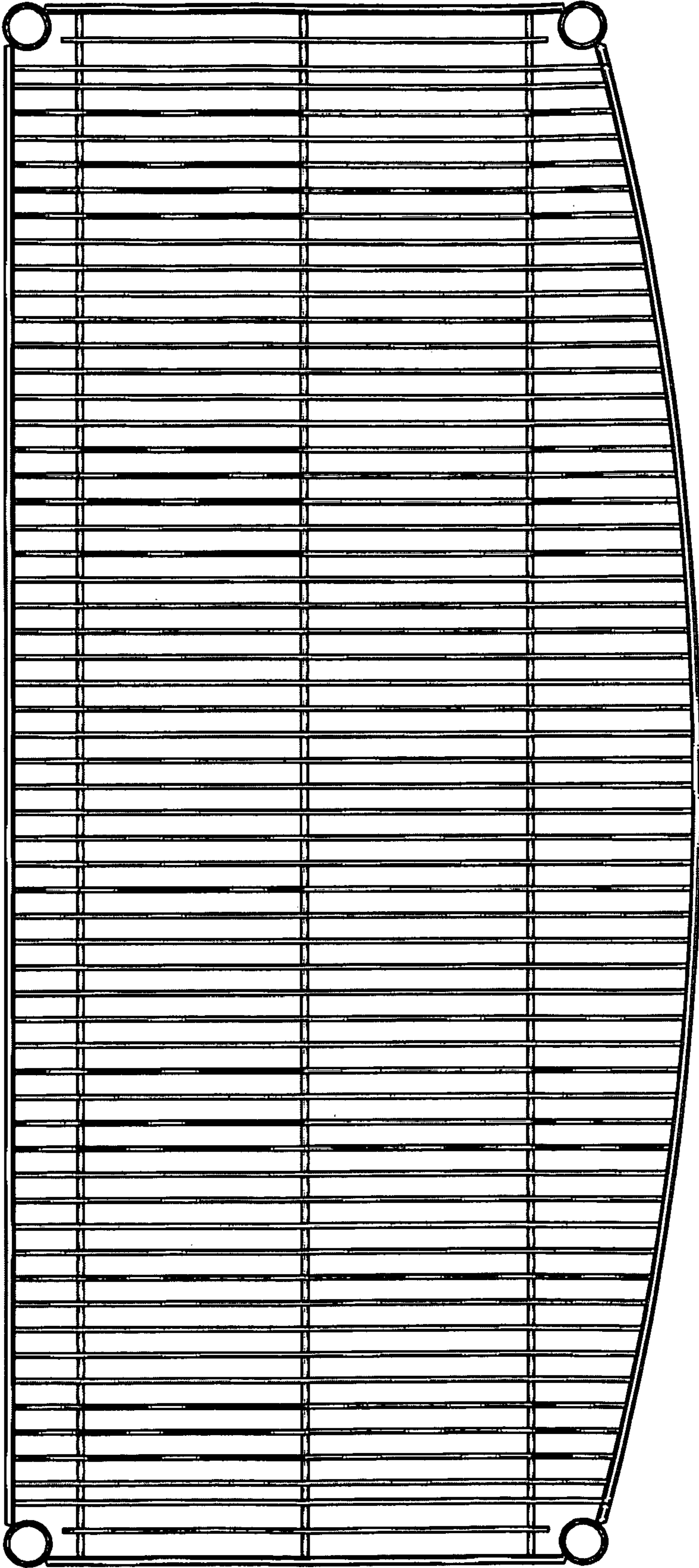

FIG. 9



FIG. 10

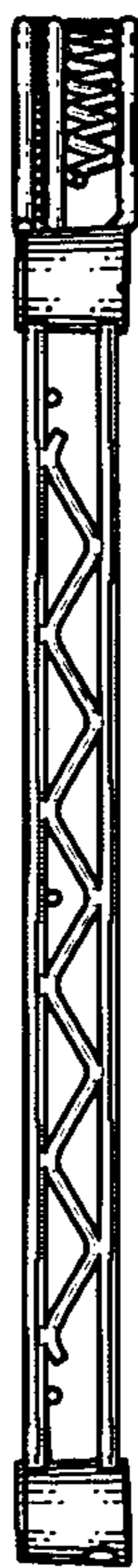

FIG. 11



FIG. 12



FIG. 13

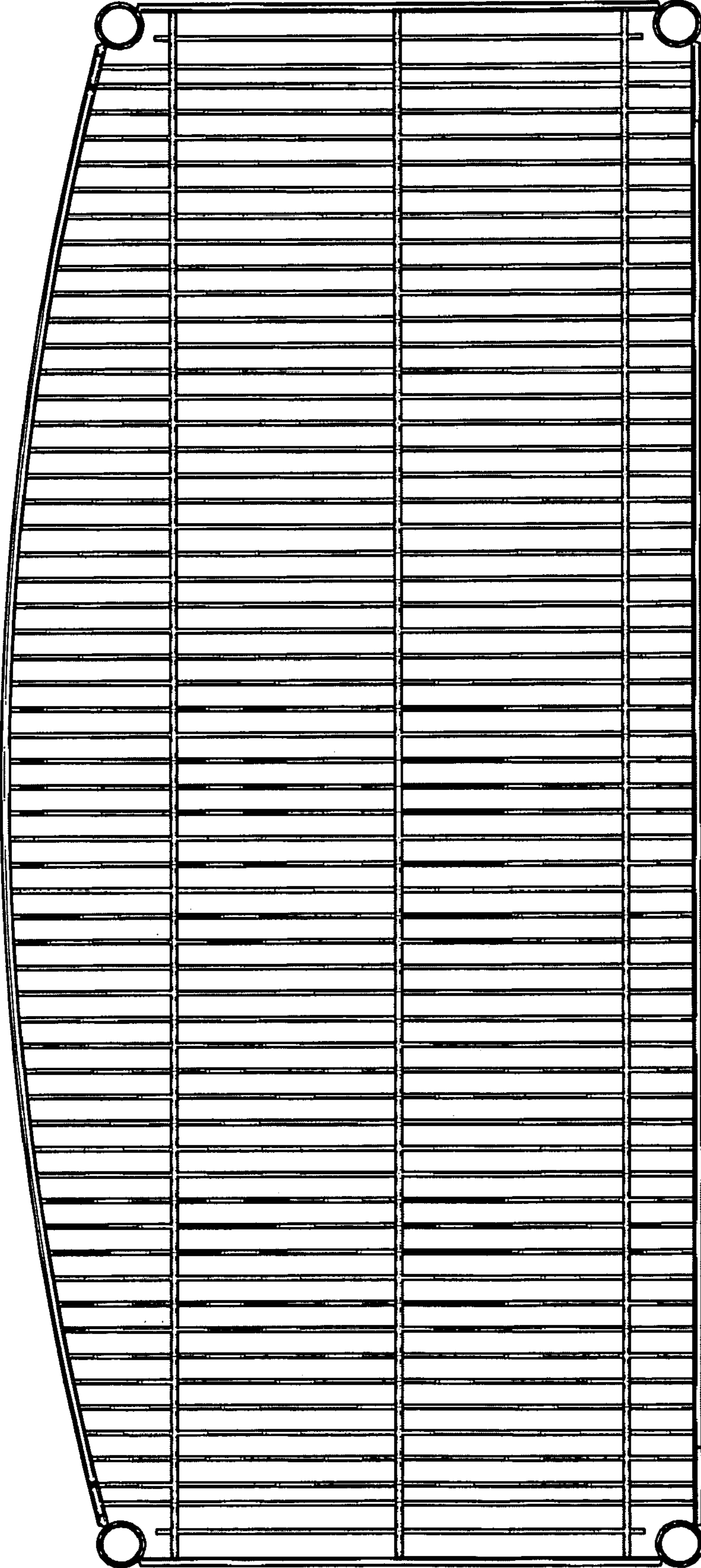

FIG. 14