



US00D589192S

(12) **United States Design Patent**
Sabernig

(10) **Patent No.:** **US D589,192 S**
(45) **Date of Patent:** **** Mar. 24, 2009**

(54) **LIGHT FIXTURE**

(75) Inventor: **Robert Sabernig**, Munster (AT)

(73) Assignee: **EGLO Leuchten GmbH**, Innsbruck (AT)

(**) Term: **14 Years**

(21) Appl. No.: **29/325,948**

(22) Filed: **Oct. 8, 2008**

(51) **LOC (9) Cl.** **26-05**

(52) **U.S. Cl.** **D26/63**

(58) **Field of Classification Search** D26/61-67,
D26/83, 86, 87, 89, 128; 362/147, 237, 238,
362/250, 282, 283, 285, 287, 288, 371, 426
See application file for complete search history.

(56) **References Cited**

U.S. PATENT DOCUMENTS

261,915	A *	8/1882	Ewing et al.	362/337
1,581,581	A *	4/1926	Lewis	362/282
D105,288	S *	7/1937	Levy	D26/63
D234,219	S *	1/1975	Donato	D26/65
D300,258	S *	3/1989	Rubarth	D26/87
D395,140	S *	6/1998	O'Rourke	D26/63
D438,320	S *	2/2001	Tang	D26/63
D462,801	S *	9/2002	Huang	D26/63
D464,455	S *	10/2002	Fong et al.	D26/63

* cited by examiner

Primary Examiner—Clare E Heflin

(74) *Attorney, Agent, or Firm*—Baker & McKenzie LLP

(57) **CLAIM**

The ornamental design for a light fixture, as shown and described.

DESCRIPTION

FIG. 1 is a perspective view of a light fixture in accordance with my design;

FIG. 2 is a front elevation view of the light fixture in accordance with my design;

FIG. 3 is a back elevation view of the light fixture in accordance with my design;

FIG. 4 is a top plan view of the light fixture in accordance with my design;

FIG. 5 is a bottom plan view of the light fixture in accordance with my design; and,

FIG. 6 is a side elevation view of the light fixture in accordance with my design, the opposite side being a mirror image of that shown.

The broken lines showing environmental structure are for illustrative purposes only and form no part of the claimed design.

1 Claim, 2 Drawing Sheets

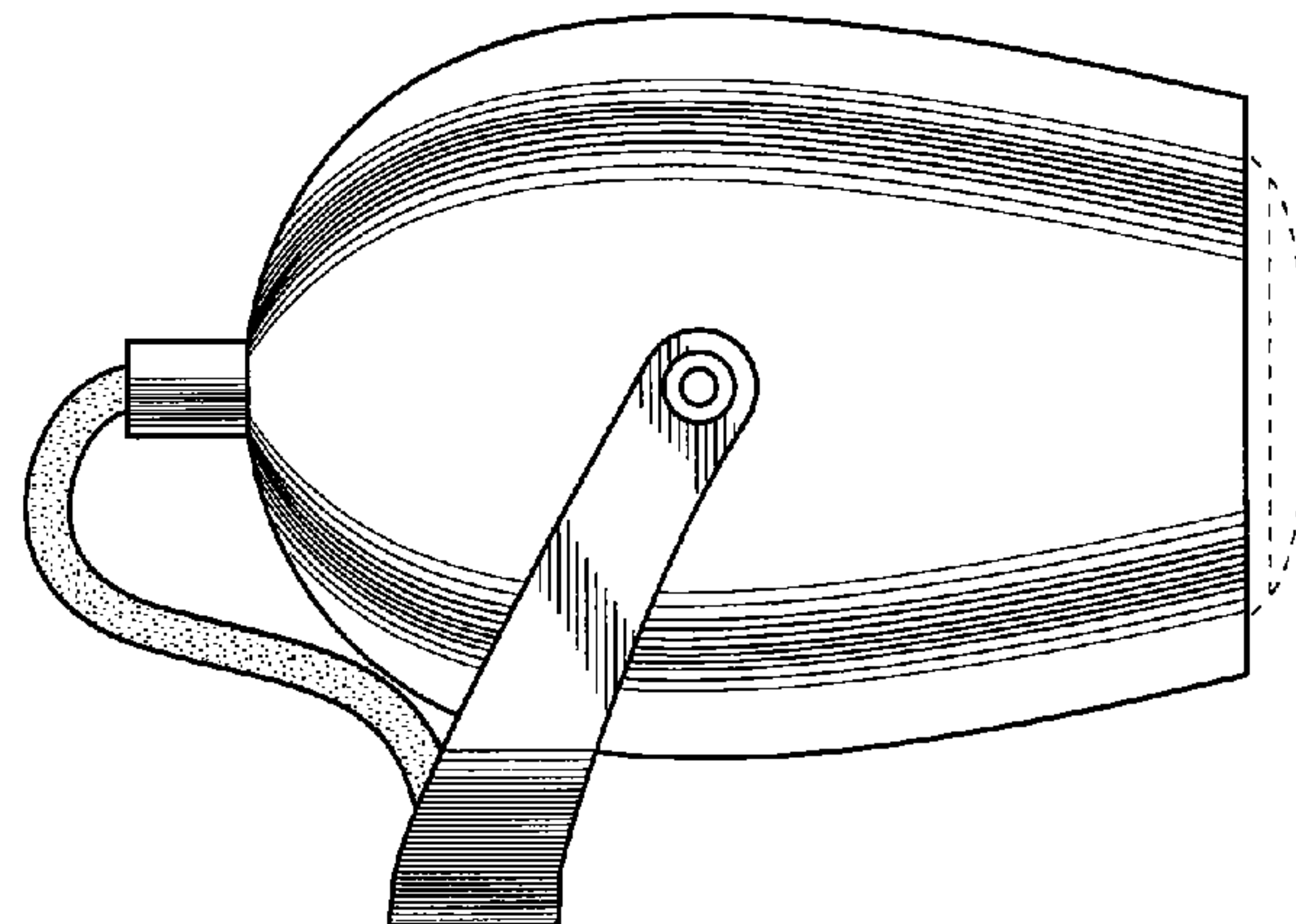
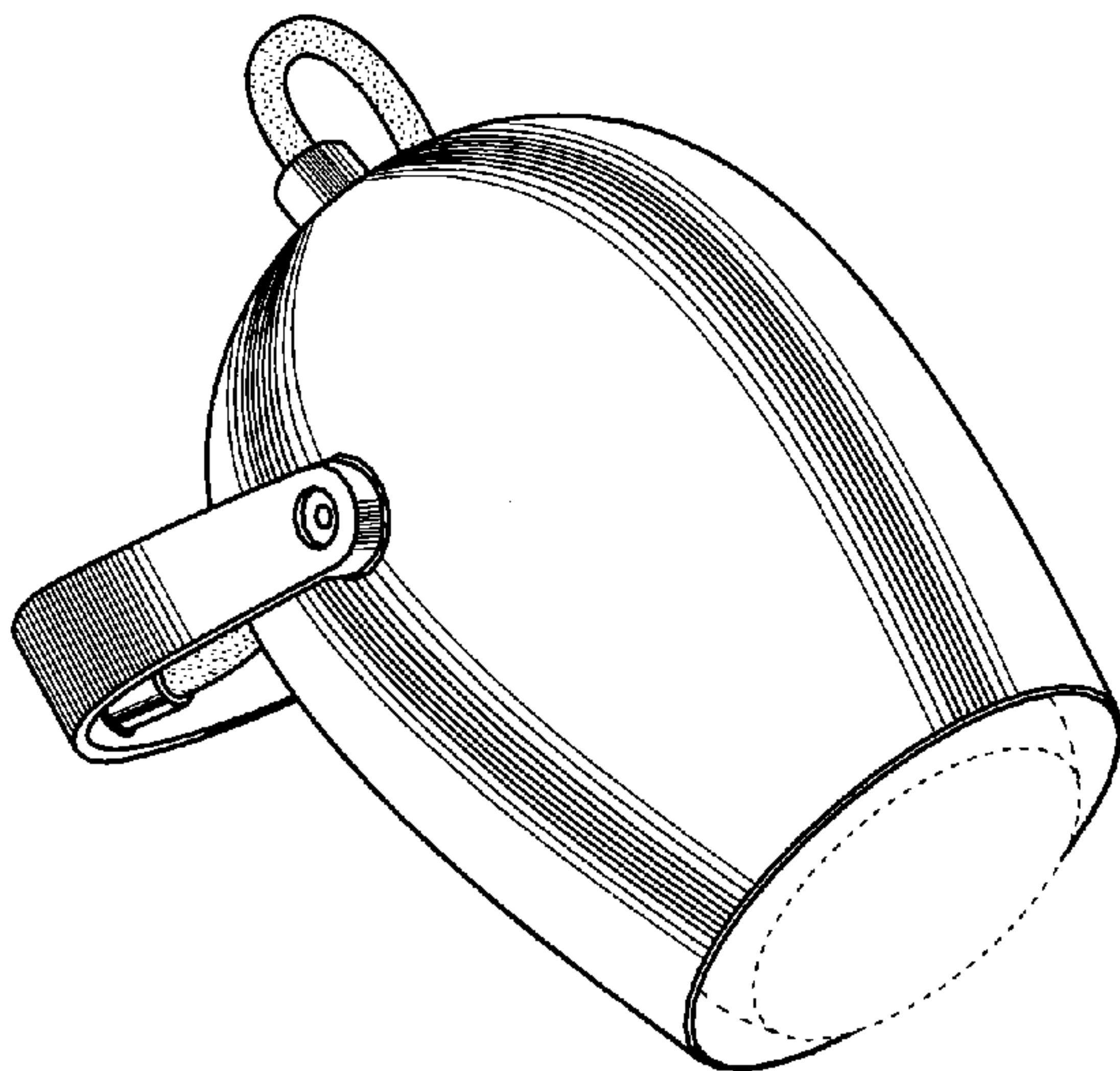

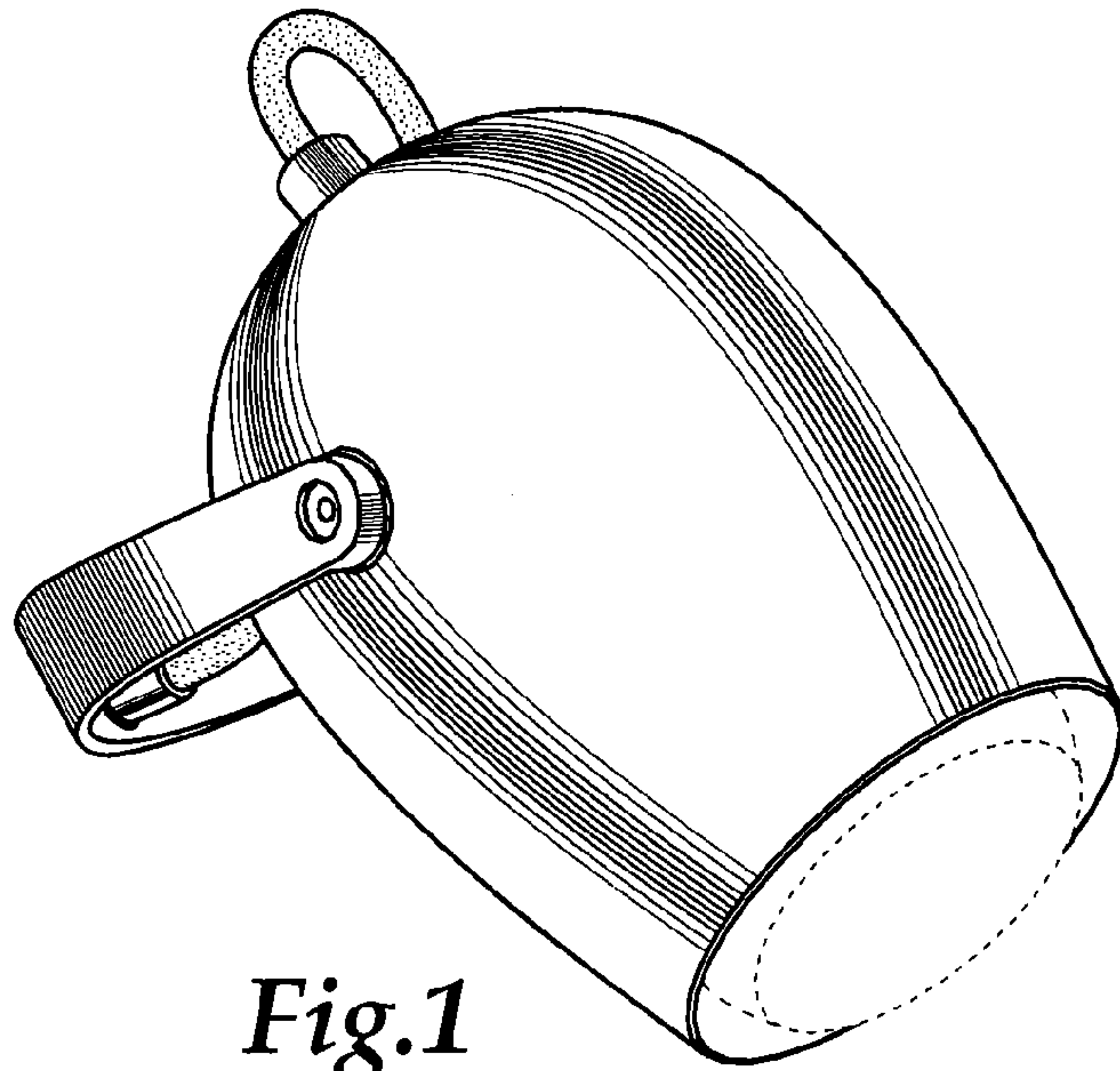

Fig.1

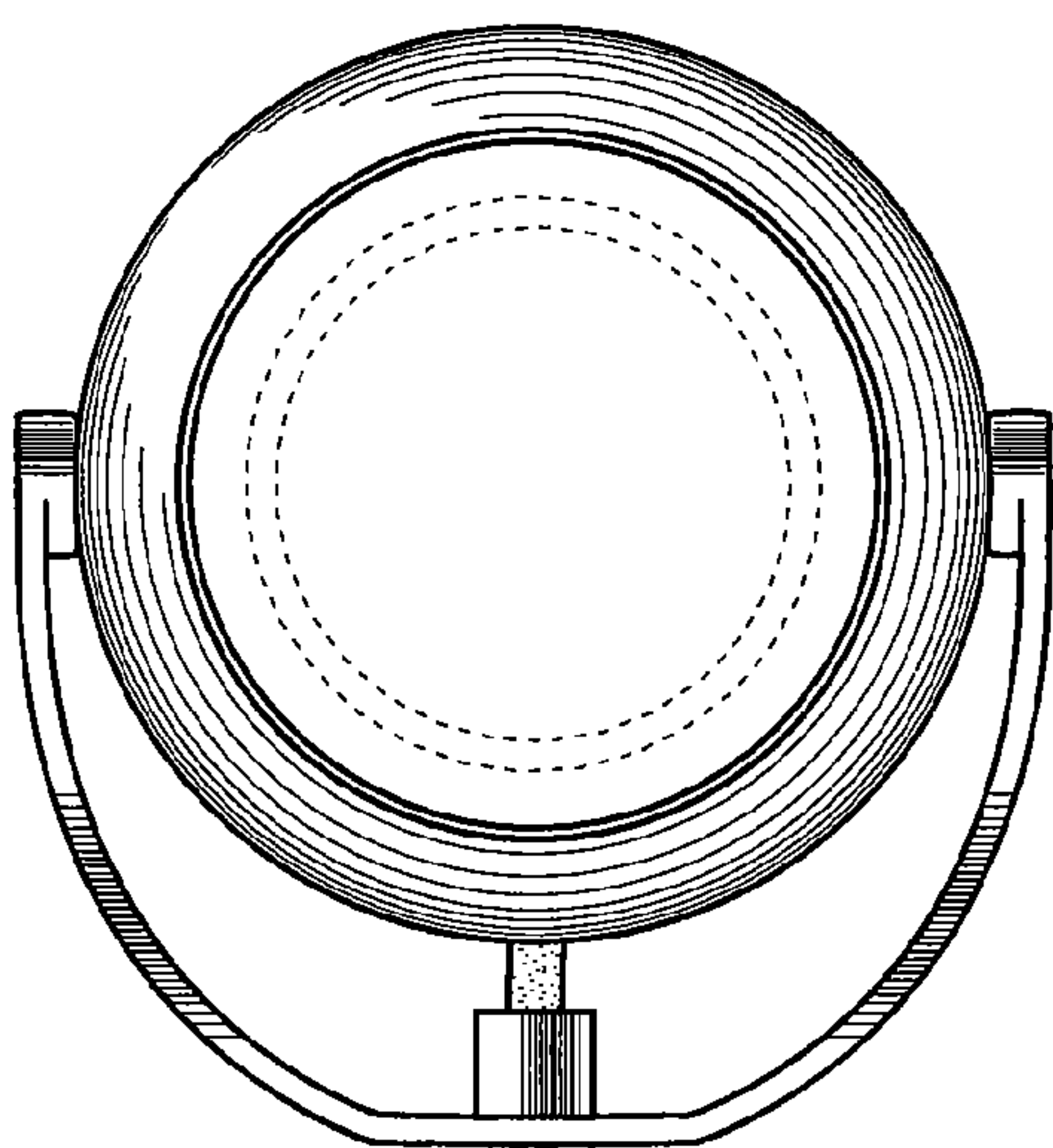

Fig.2

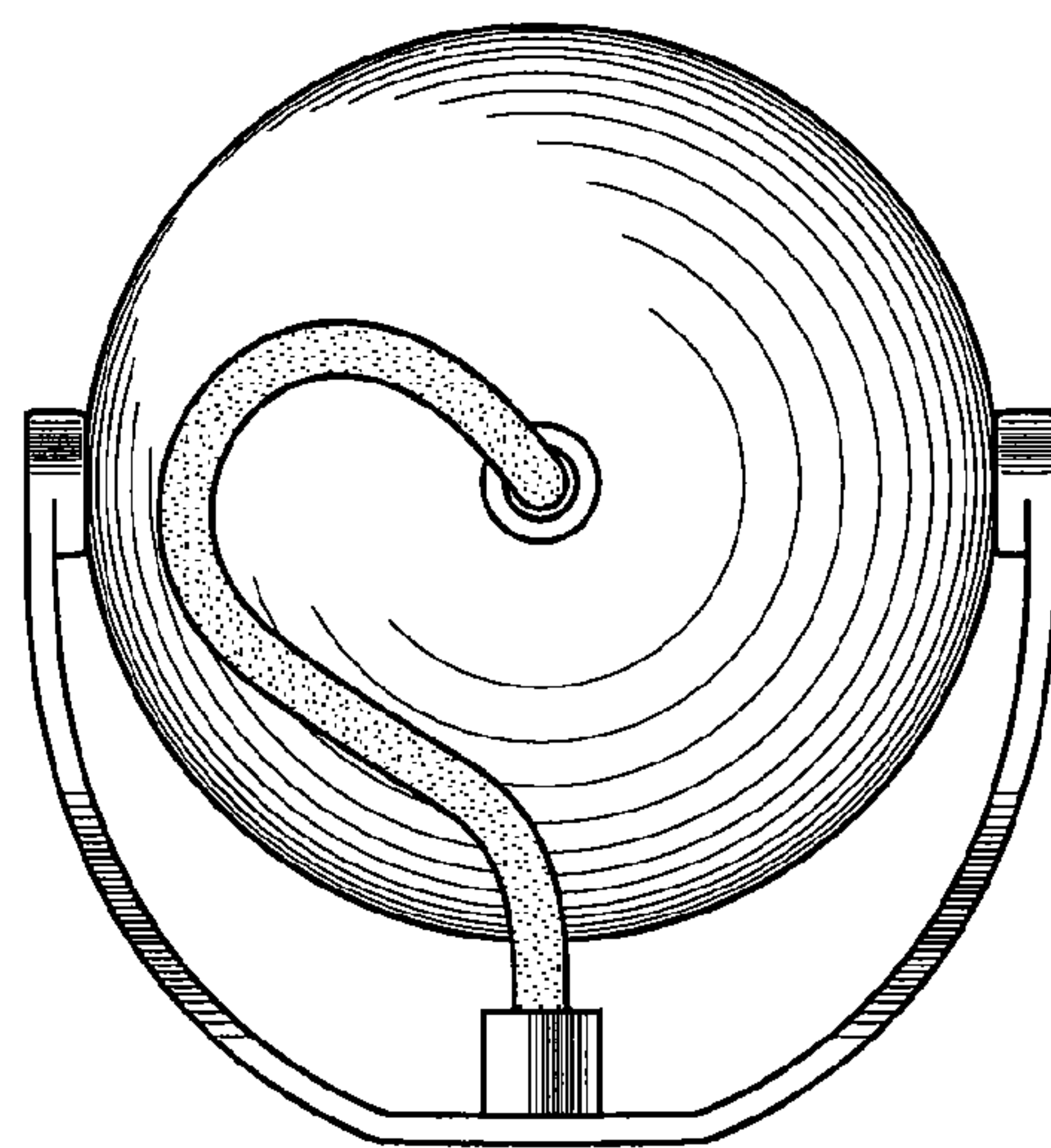

Fig.3

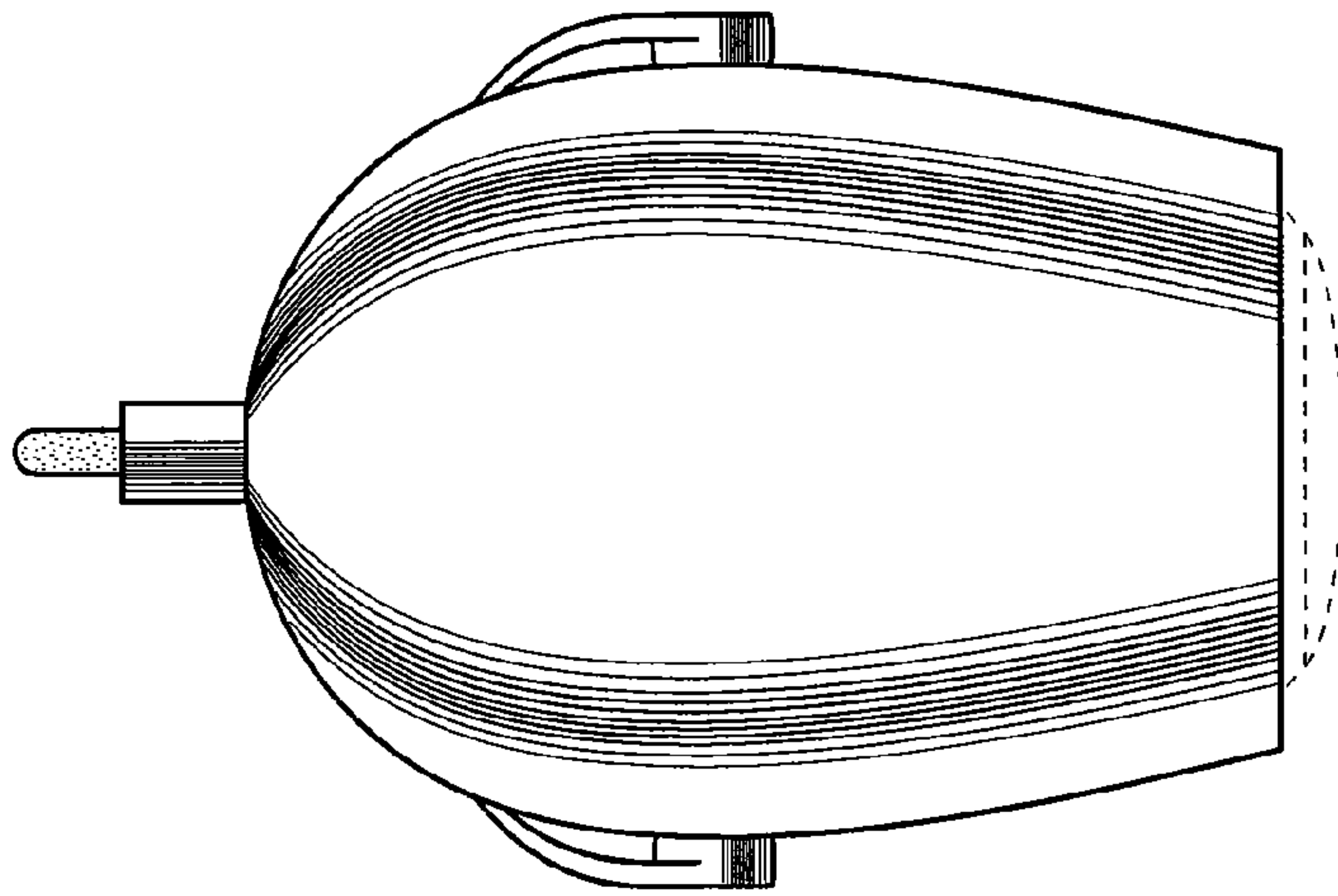

Fig.4

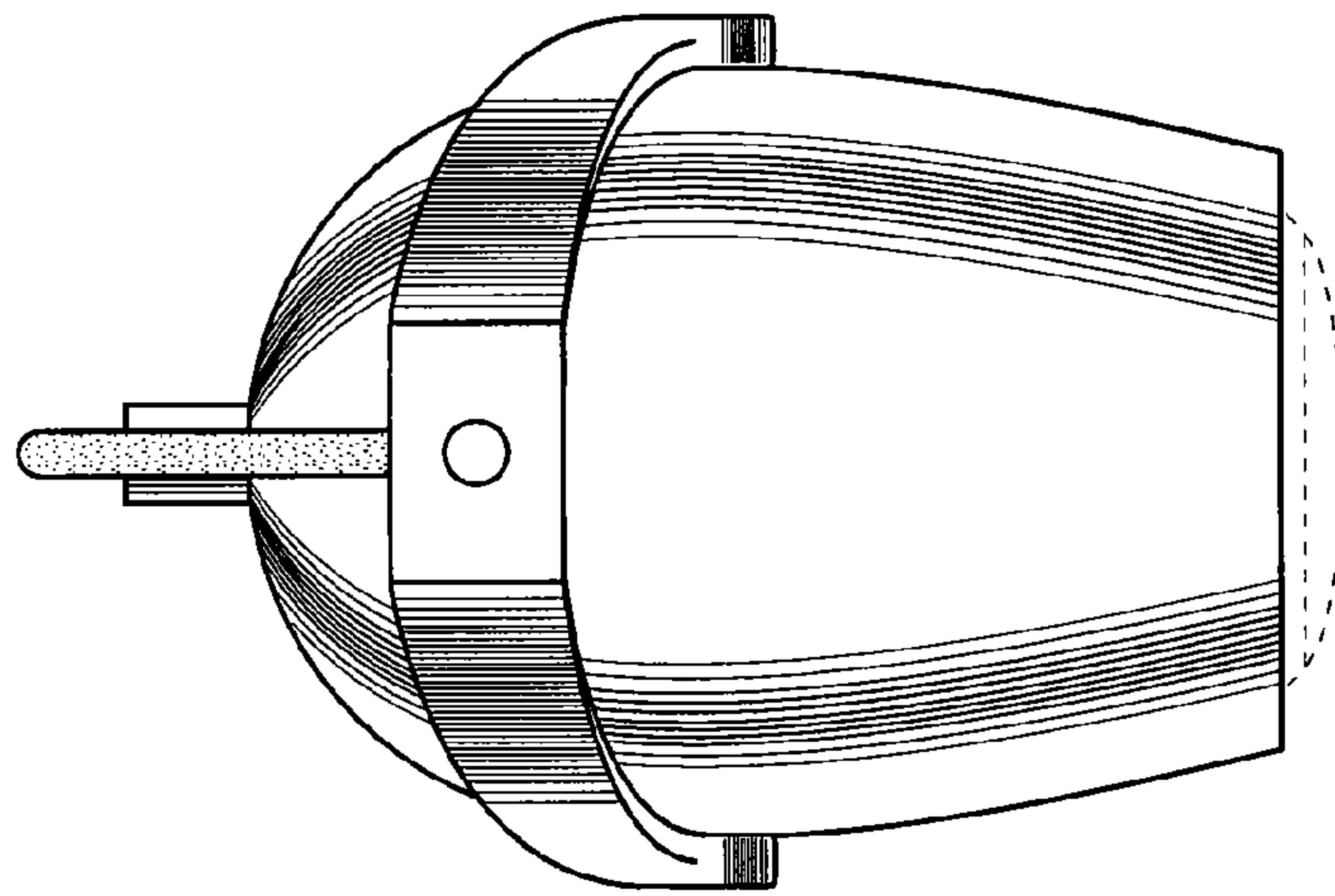

Fig.5

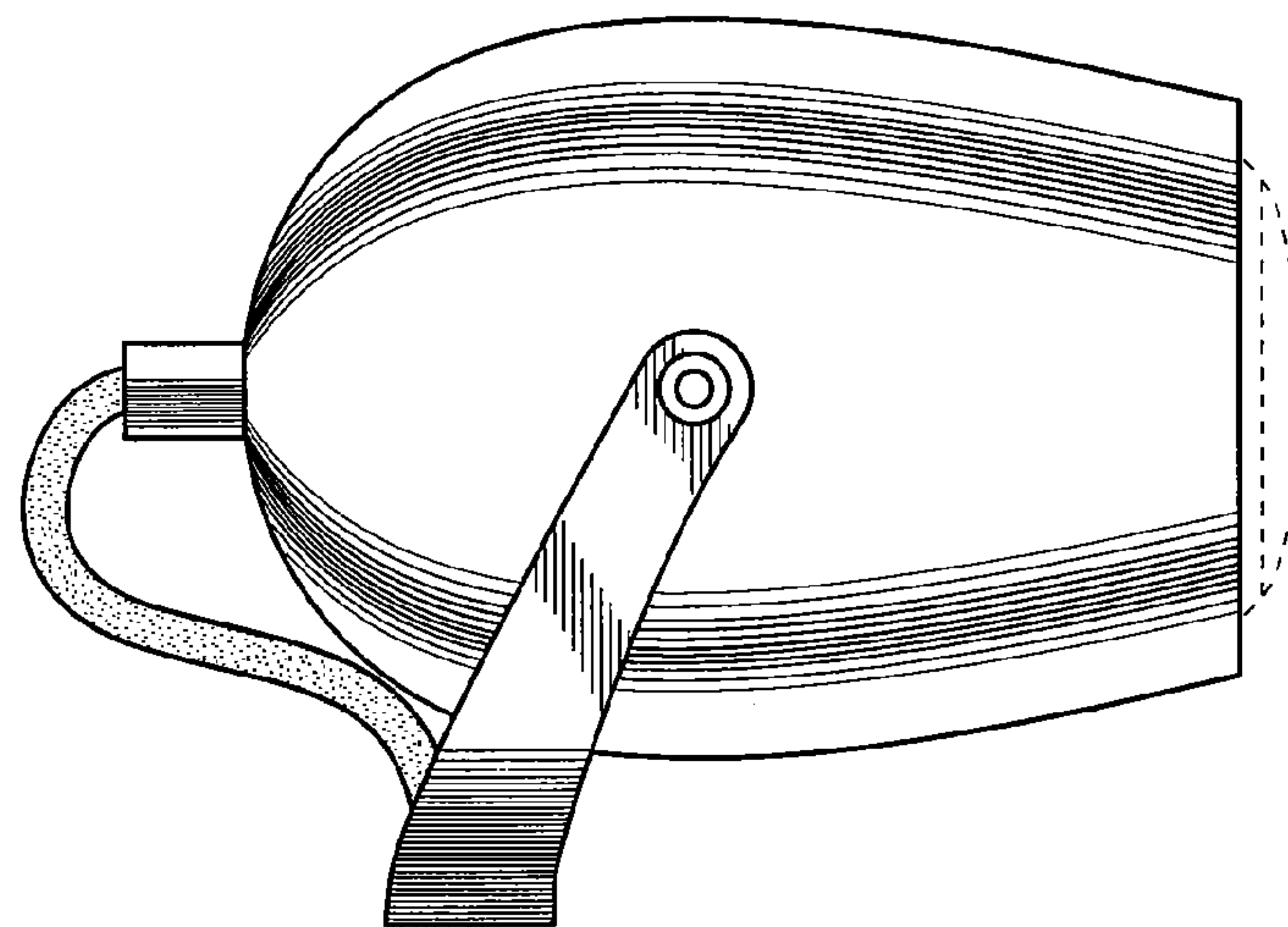

Fig.6