



US00D589153S

(12) **United States Design Patent**
Rosales

(10) **Patent No.:** **US D589,153 S**

(45) **Date of Patent:** **** Mar. 24, 2009**

(54) **BABY BOTTLE**

(76) **Inventor:** **Arieh Rosales**, Av. Andres Belle res
Daul M M Solano 3 Loc 7, Mariperez
Caracas (VE)

(**) **Term:** **14 Years**

(21) **Appl. No.:** **29/278,435**

(22) **Filed:** **Mar. 29, 2007**

(51) **LOC (9) Cl.** **07-01**

(52) **U.S. Cl.** **D24/197**

(58) **Field of Classification Search** D24/193-199;
D7/509-511, 514, 515; D9/504, 519; 220/23.83-23.86,
220/603, 705, 771; 215/2, 11.1-11.6, 365,
215/386-388, 390, 396, 398-399; 606/236;
446/75-77, 227; 248/102

See application file for complete search history.

(56) **References Cited**

U.S. PATENT DOCUMENTS

D308,575 S *	6/1990	Mariol	D24/197
D368,529 S *	4/1996	Allegre	D24/197
D420,448 S *	2/2000	Brown et al.	D24/197
D425,994 S *	5/2000	Hakim	D24/197
D430,676 S *	9/2000	Kong	D24/197
6,112,919 A *	9/2000	Ho	215/11.4
D441,087 S *	4/2001	Johansen et al.	D24/197

D441,872 S *	5/2001	Johansen et al.	D24/197
D454,642 S *	3/2002	Hakim	D24/197
D470,593 S *	2/2003	Iodice	D24/197
D476,849 S *	7/2003	Randolph	D7/510
D478,669 S *	8/2003	Wear	D24/197
D538,939 S *	3/2007	Conaway et al.	D24/197

* cited by examiner

Primary Examiner—Stella M. Reid

Assistant Examiner—Susan E Krakower

(74) *Attorney, Agent, or Firm*—Sanchelima & Assoc., P.A.

(57) **CLAIM**

The ornamental design for a baby bottle, as shown and described.

DESCRIPTION

FIG. 1 is an isometric view of a baby bottle showing my new design;

FIG. 2 is an isometric view thereof without cap;

FIG. 3 is a front elevational view thereof, the rear and side views being a mirror image;

FIG. 4 is front elevational view thereof without cap, the rear and side views being a mirror image;

FIG. 5 is a top plan view thereof; and,

FIG. 6 is a bottom plan view thereof showing my design.

1 Claim, 3 Drawing Sheets

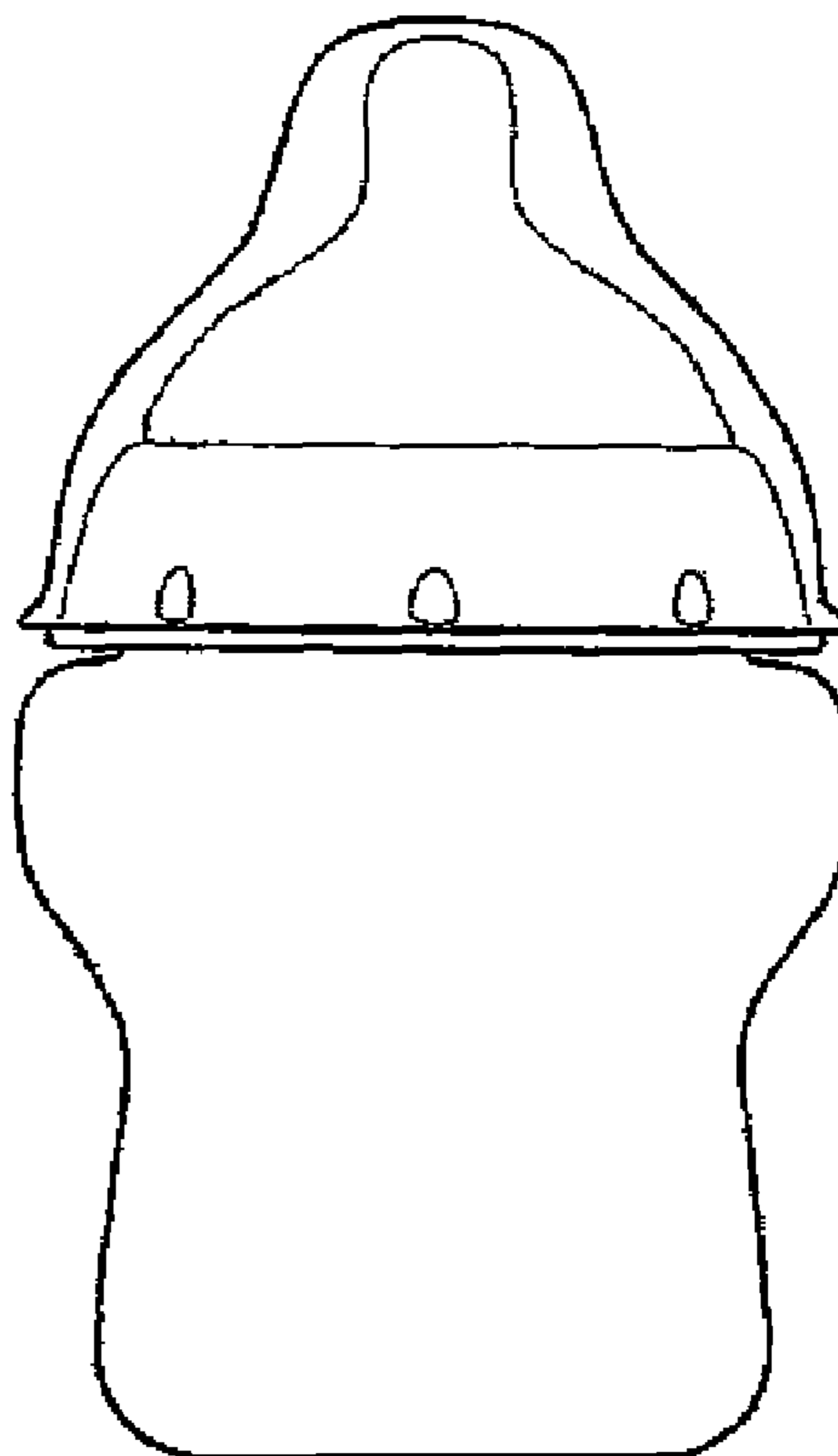
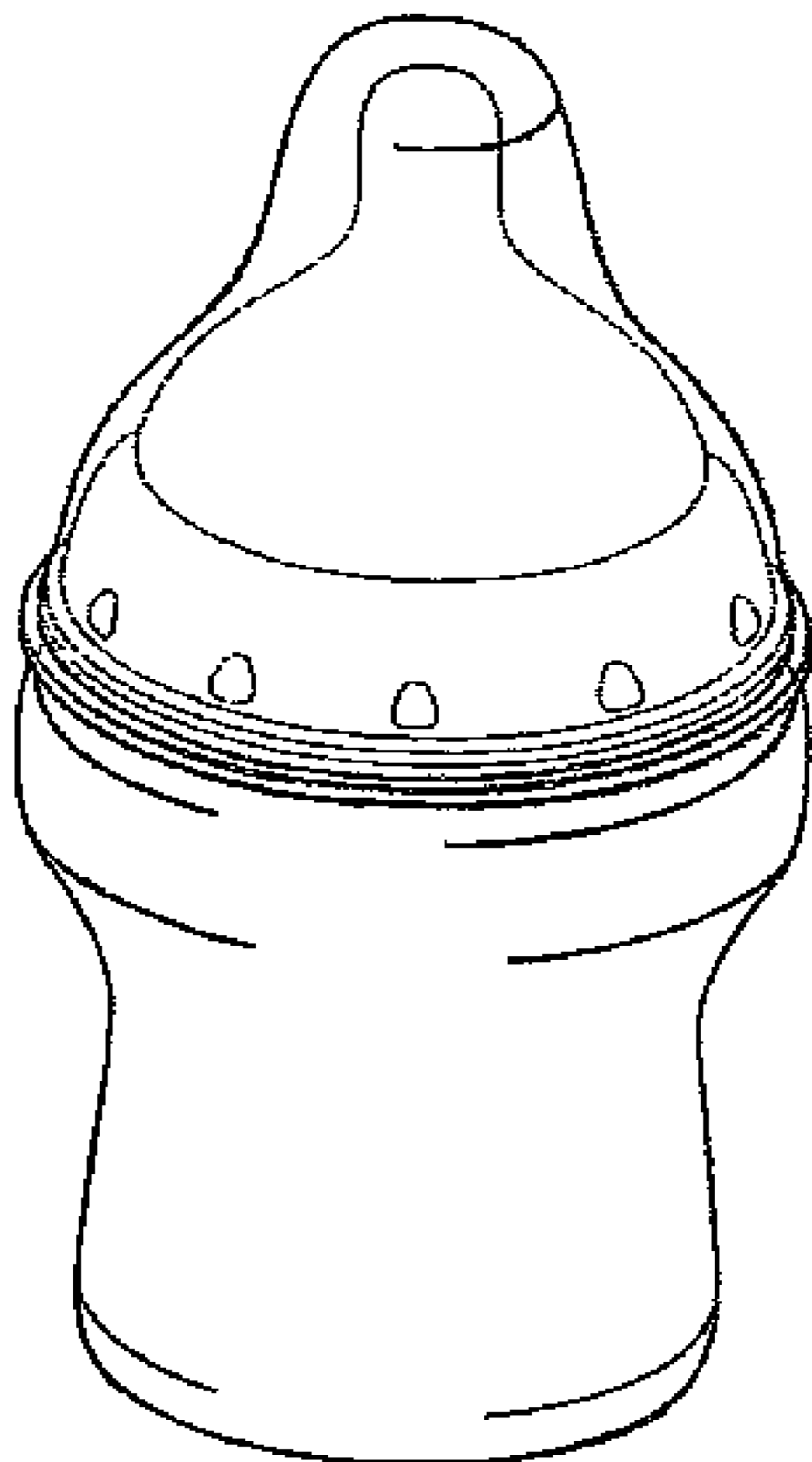

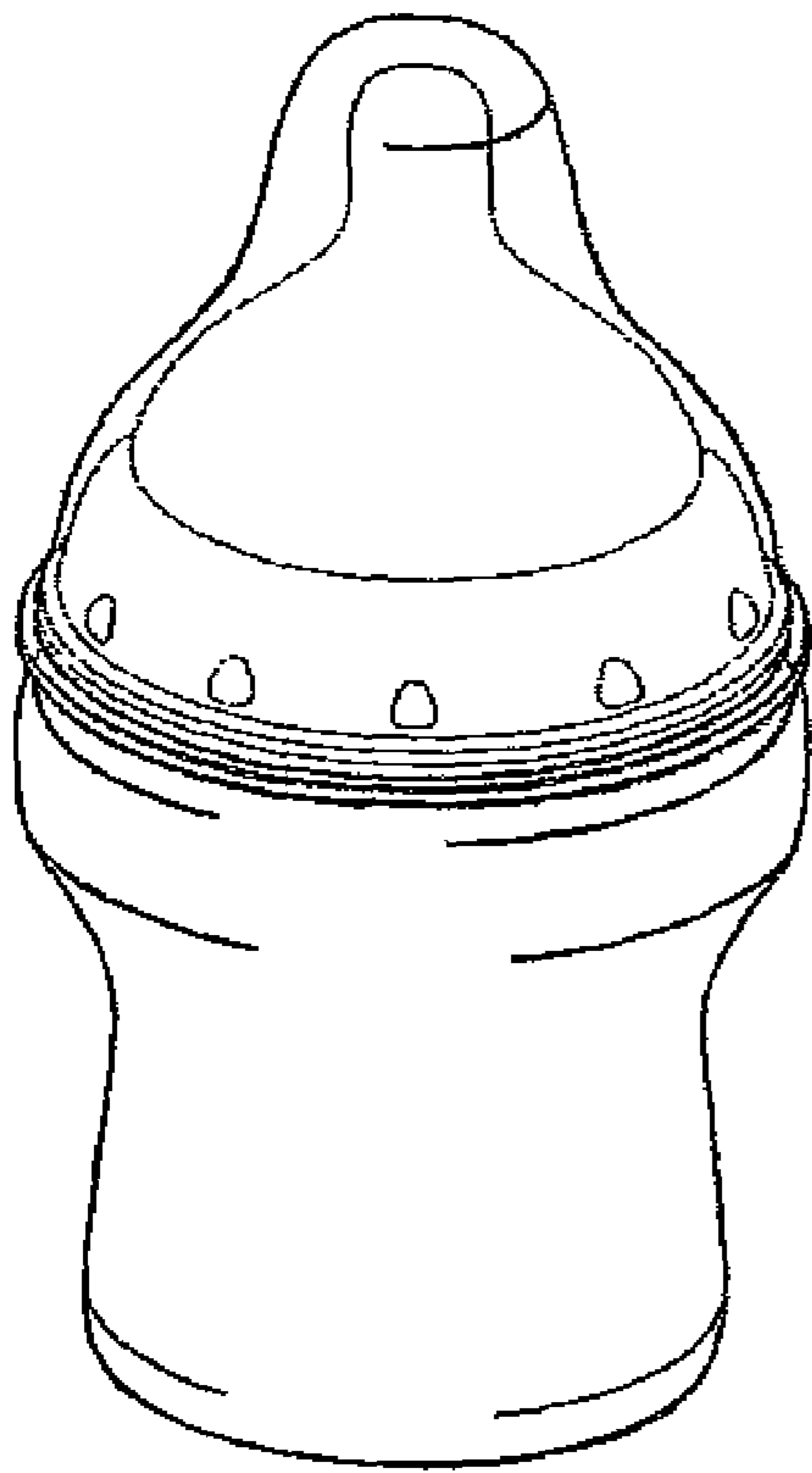

FIG. 1

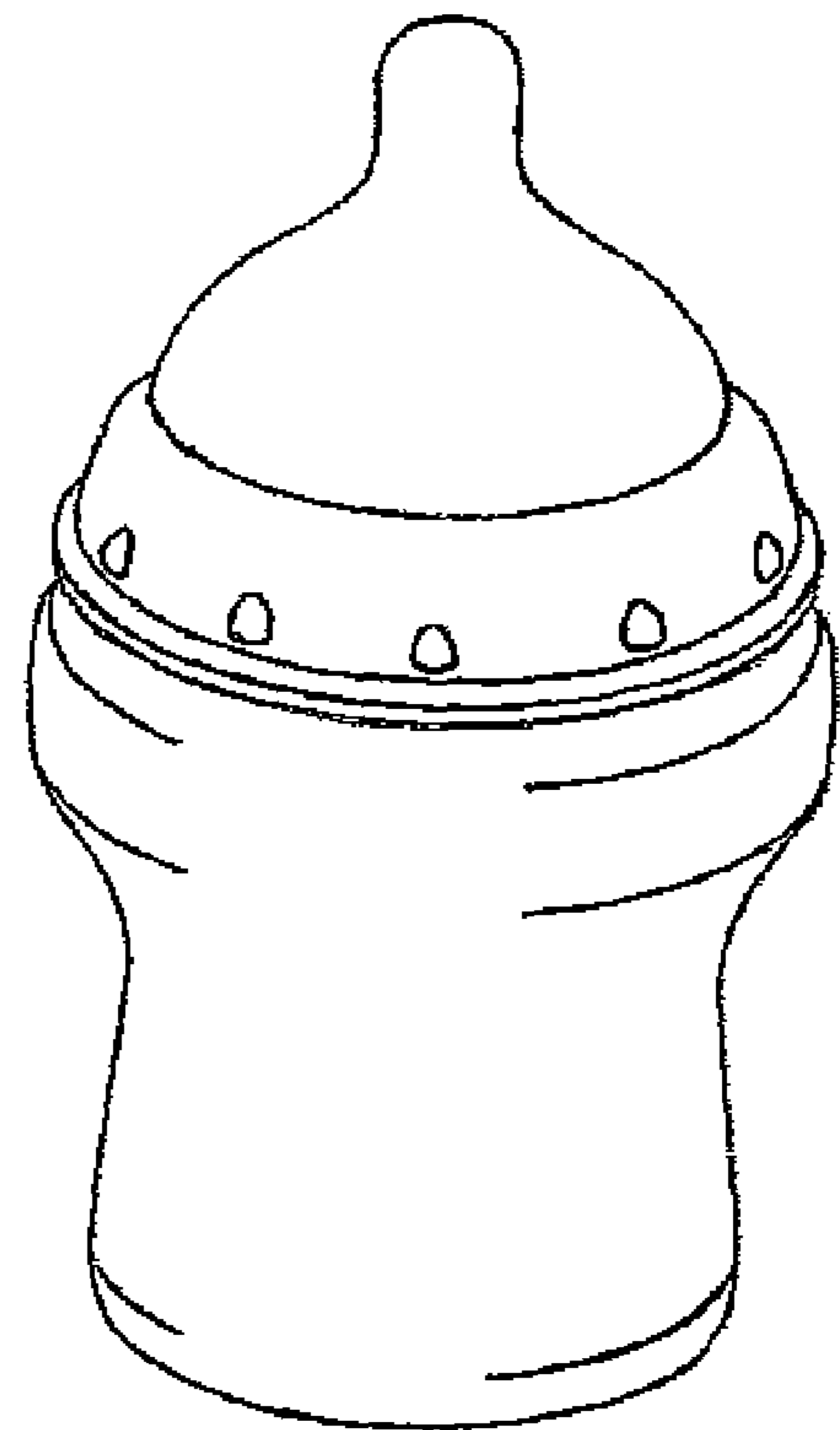

FIG. 2

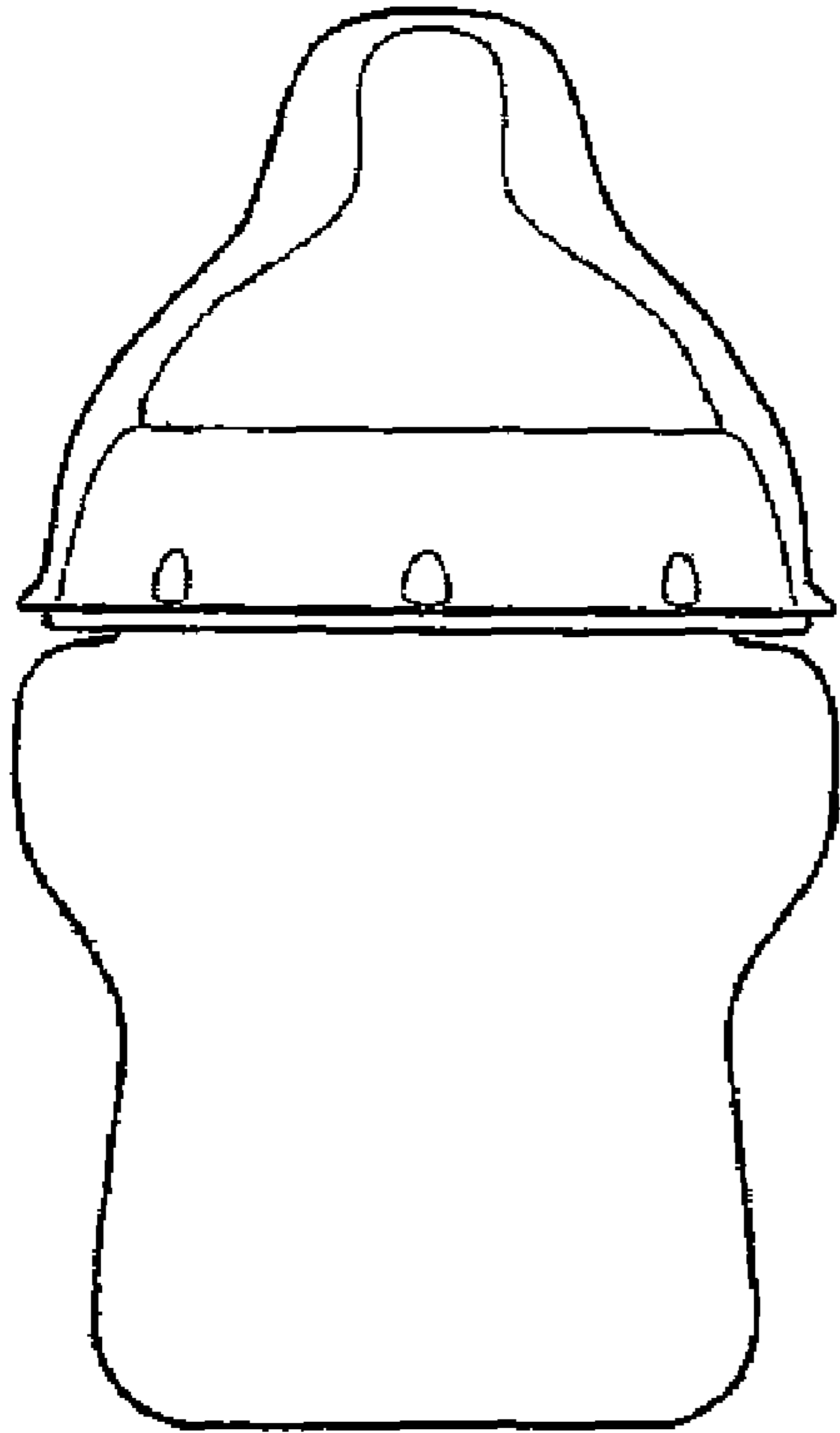

FIG. 3

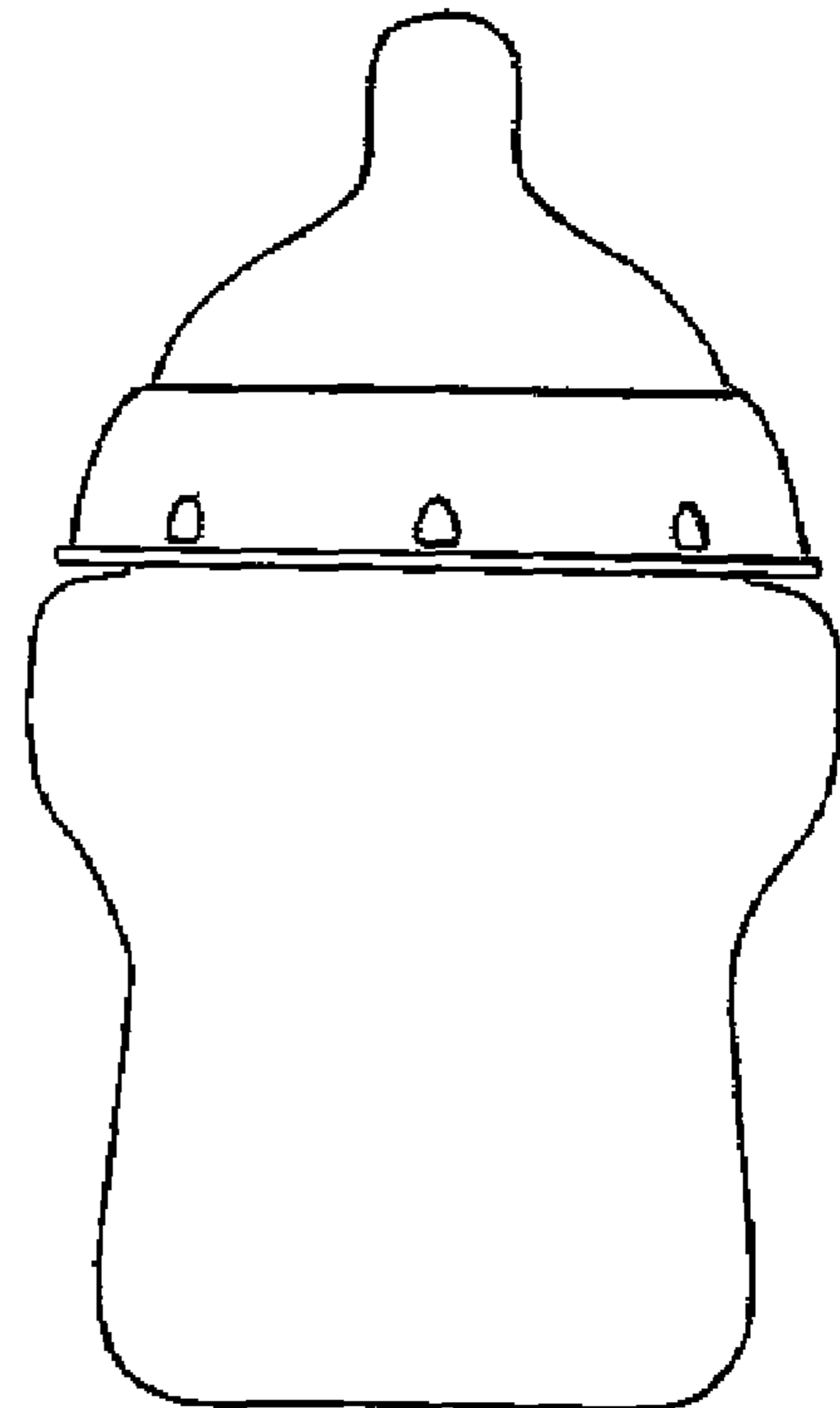

FIG. 4

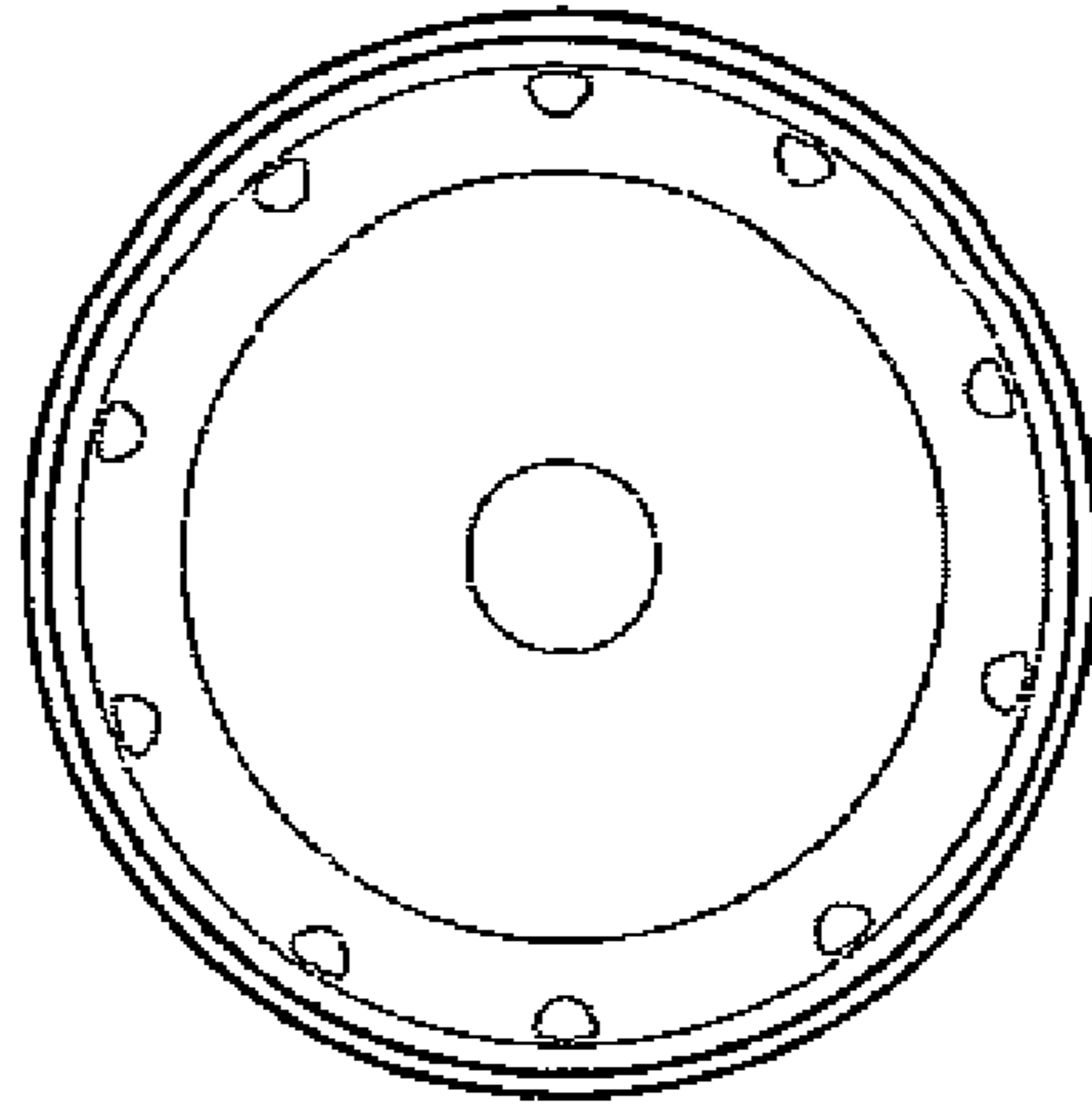

FIG. 5

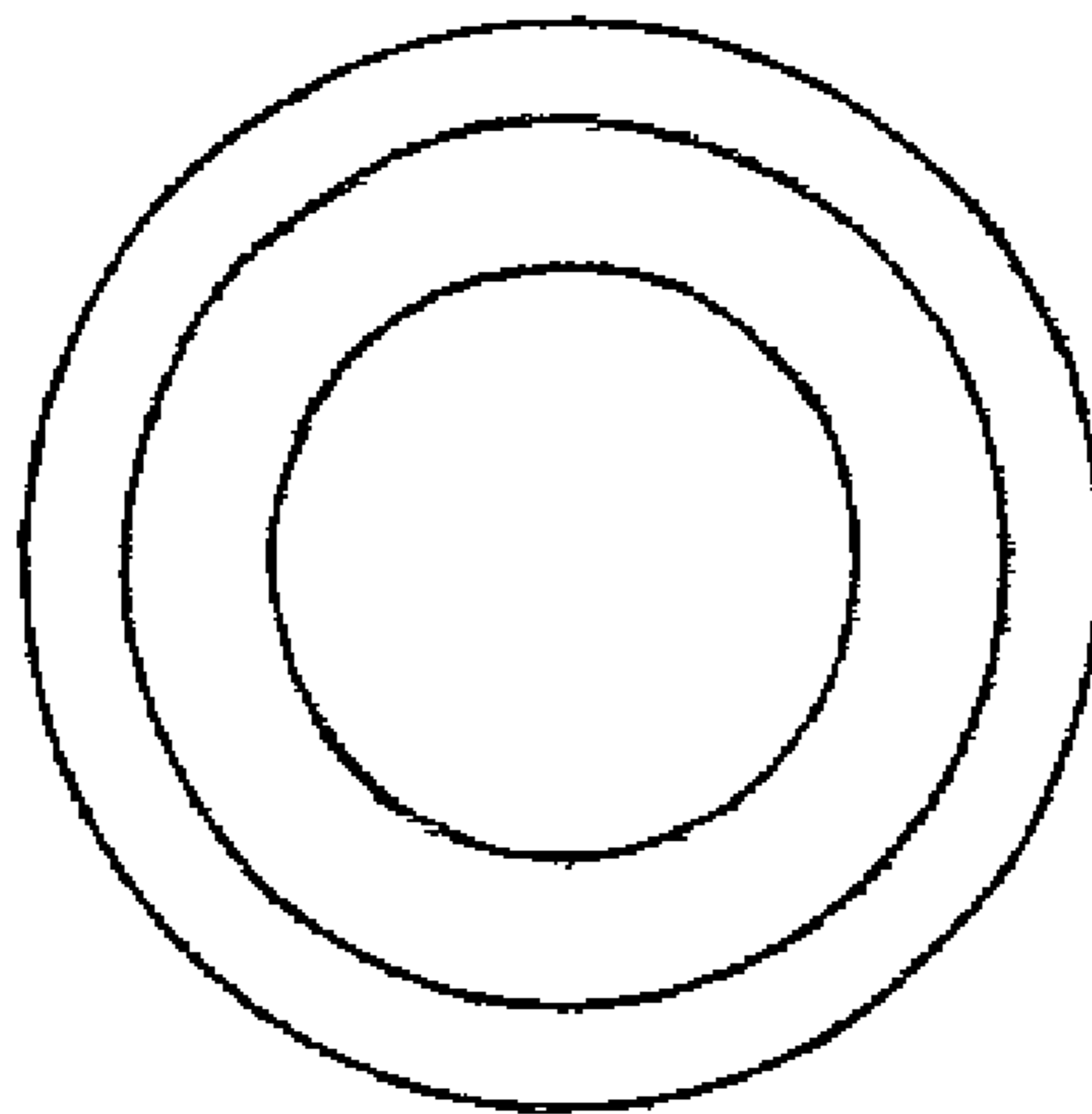

FIG. 6