



US00D589023S

(12) **United States Design Patent**
Oh

(10) **Patent No.:** **US D589,023 S**
(45) **Date of Patent:** **** Mar. 24, 2009**

(54) **HANDSET**

(75) Inventor: **Christine Oh**, Los Angeles, CA (US)

(73) Assignee: **Nokia Corporation**, Espoo (FI)

(**) Term: **14 Years**

(21) Appl. No.: **29/305,515**

(22) Filed: **Mar. 21, 2008**

(51) **LOC (9) Cl.** **14-03**

(52) **U.S. Cl.** **D14/138 AB**

(58) **Field of Classification Search** D14/138 AB,
D14/138 AA, 496, 341-347, 247, 455-456,
D14/218; 455/575.3, 575.1

See application file for complete search history.

(56) **References Cited**

U.S. PATENT DOCUMENTS

D486,461 S * 2/2004 Seo et al. D14/138 AB
D500,016 S * 12/2004 Kim D14/138 AB

(Continued)

OTHER PUBLICATIONS

Nokia 6600 fold telephone, announced Jun. 2008, [online], [site visited Nov. 4, 2008]. Available from Internet ,<URL: http://www.gsmarena.com>.*

Samsung B300 telephone, announced Jun. 2008, [online], [site visited Nov. 4, 2008]. Available from Internet ,<URL: http://www.gsmarena.com>.*

Nokia 6060 telephone, announced Jun. 2005, [online], [site visited Nov. 4, 2008]. Available from Internet ,<URL: http://www.gsmarena.com>.*

LG CU515 telephone, announced Oct. 2007, [online], [site visited Nov. 4, 2008]. Available from Internet ,<URL: http://www.gsmarena.com>.*

LG U830 telephone, announced Oct. 2006, [online], [site visited Nov. 4, 2008]. Available from Internet ,<URL: http://www.gsmarena.com>.*

BenQ M350 telephone, announced 2nd quarter 2005, [online], [site visited Nov. 4, 2008]. Available from Internet ,<URL: http://www.gsmarena.com>.*

Nokia 6650 telephone, announced Mar. 2008, [online], [site visited Nov. 4, 2008]. Available from Internet ,<URL: http://www.gsmarena.com>.*

Primary Examiner—Jeffrey D Asch

(74) *Attorney, Agent, or Firm*—Banner & Witcoff, Ltd.

(57) **CLAIM**

The ornamental design for a handset, as shown and described.

DESCRIPTION

FIG. 1 is a bottom view of a handset showing my new design in a closed position;

FIG. 2 is a right side view thereof;

FIG. 3 is a front view thereof;

FIG. 4 is a left side view thereof;

FIG. 5 is a top view thereof;

FIG. 6 is a rear view thereof;

FIG. 7 is a perspective front view thereof;

FIG. 8 is a bottom view of a handset showing my new design in an open, in-use position;

FIG. 9 is a right side view thereof;

FIG. 10 is a front view thereof;

FIG. 11 is a left side view thereof;

FIG. 12 is a top view thereof;

FIG. 13 is a rear view thereof; and,

FIG. 14 is a perspective front view thereof.

1 Claim, 5 Drawing Sheets

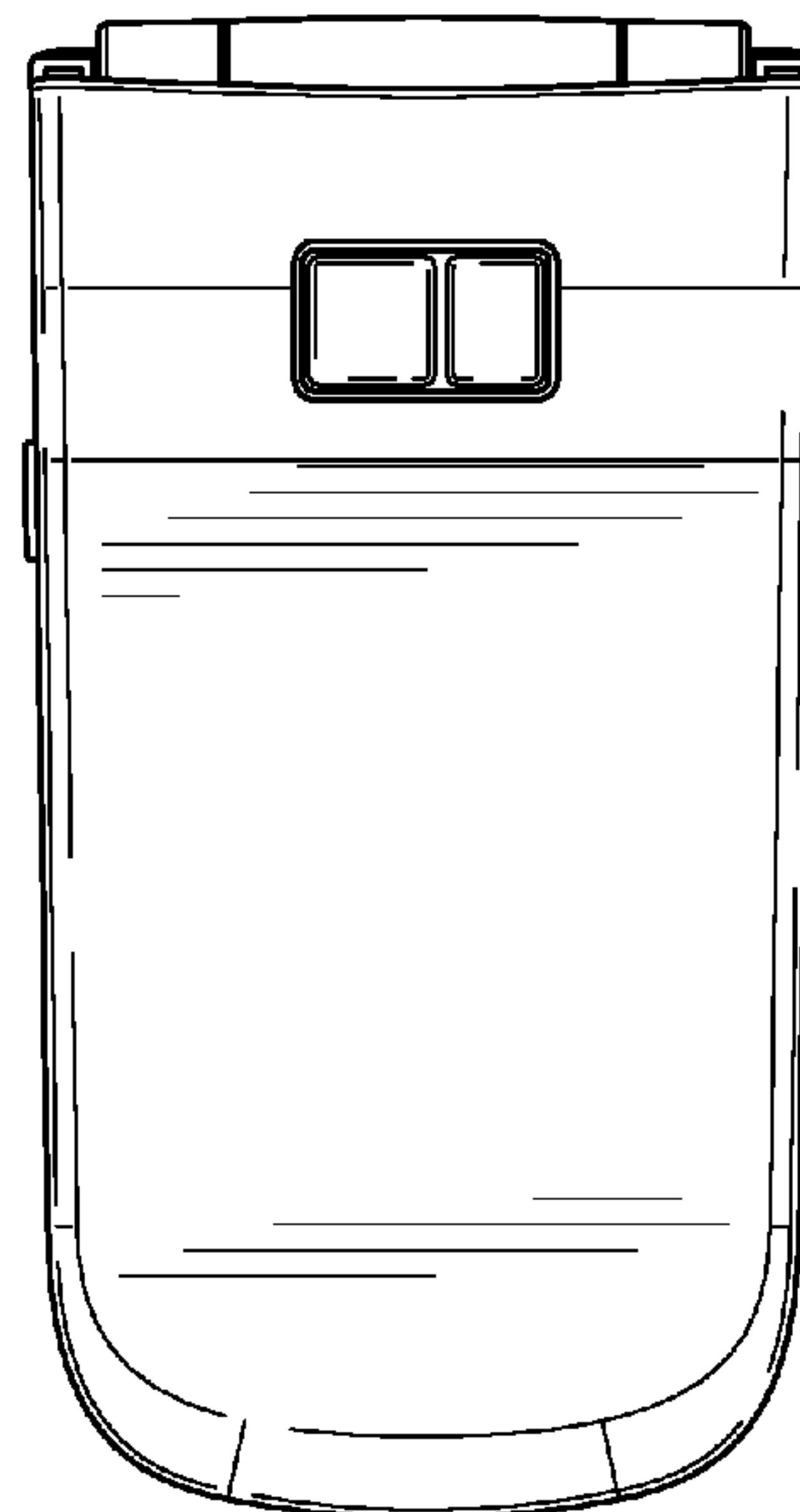
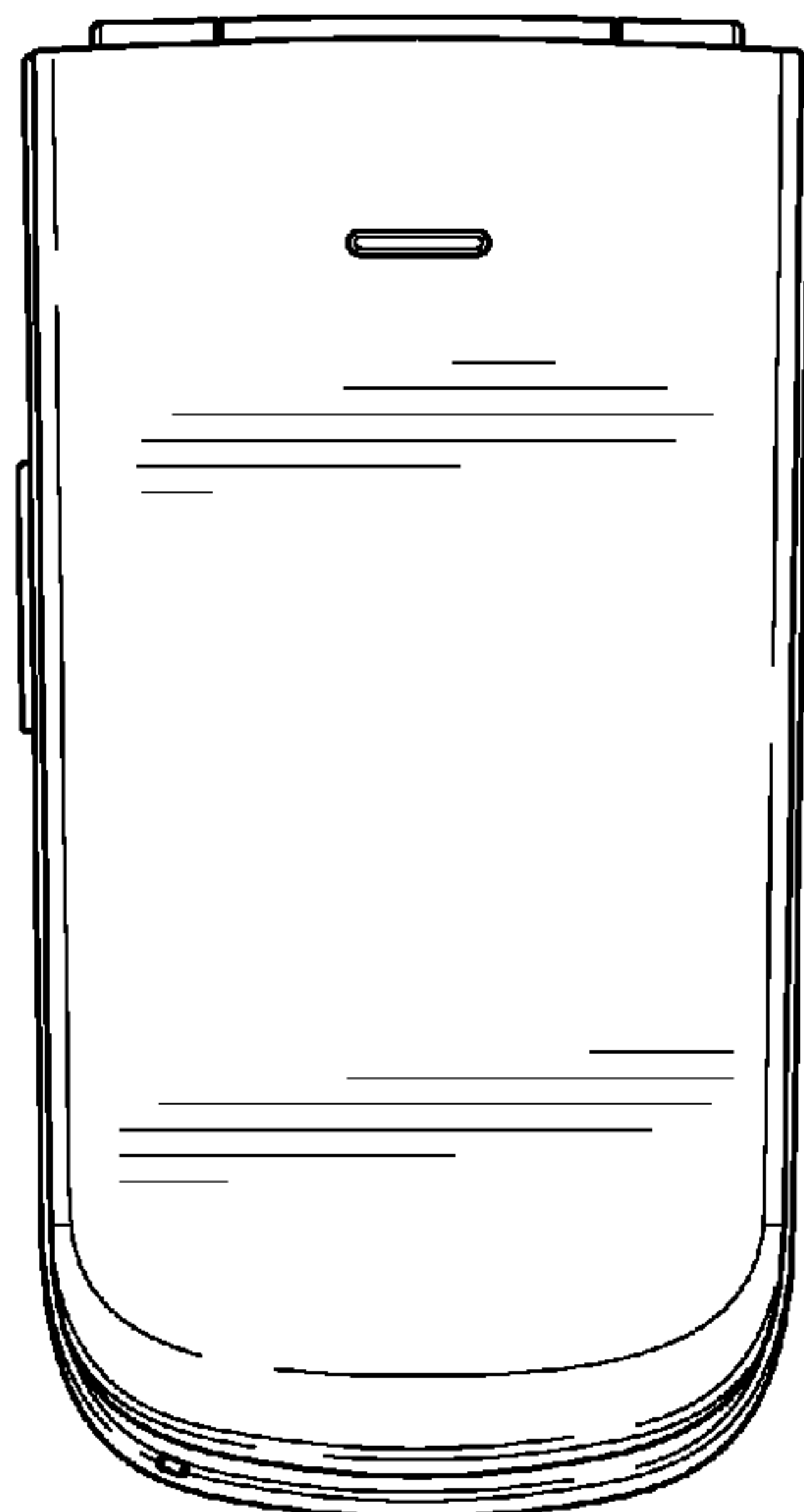

US D589,023 S

Page 2

U.S. PATENT DOCUMENTS

D522,989 S	6/2006	Viitasaari	
D537,429 S *	2/2007	Fahlgren	D14/138 AB
D542,770 S *	5/2007	Bower	D14/138 AB
7,286,861 B2 *	10/2007	Woo	455/575.3
D555,614 S	11/2007	Holmung et al.	
D556,166 S *	11/2007	Lee et al.	D14/138 AB
D563,359 S *	3/2008	Kim et al.	D14/138 AB
D563,365 S *	3/2008	Kim	D14/138 AB
D564,481 S *	3/2008	Su	D14/138 AB
D568,850 S *	5/2008	Lyles	D14/138 AB
D568,859 S *	5/2008	Choi	D14/138 AB
D571,343 S *	6/2008	Cha et al.	D14/138
D572,224 S *	7/2008	Kim et al.	D14/138
D572,225 S *	7/2008	Choi et al.	D14/138
D572,686 S *	7/2008	Kim et al.	D14/138
D572,689 S *	7/2008	Park et al.	D14/138
D572,690 S *	7/2008	Kim et al.	D14/138
D573,574 S *	7/2008	Suk et al.	D14/138
D573,963 S *	7/2008	Kim et al.	D14/138
D574,349 S	8/2008	Mitchell	
D576,984 S *	9/2008	Park et al.	D14/138 AB
D578,102 S *	10/2008	Park	D14/138 AB
D578,504 S *	10/2008	Stillerman	D14/138 AB
D578,979 S *	10/2008	Choi et al.	D14/138 R
D578,982 S *	10/2008	Jeong et al.	D14/138 R
2006/0183516 A1 *	8/2006	Ham	455/575.3

* cited by examiner

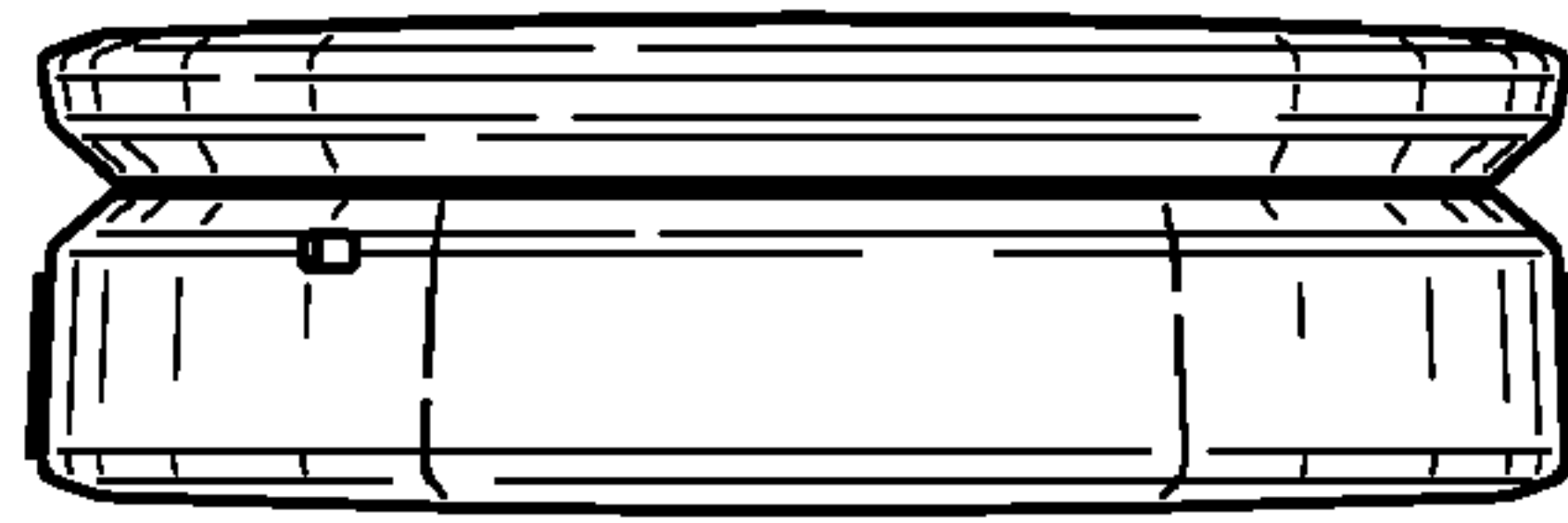

FIG. 1



FIG. 2

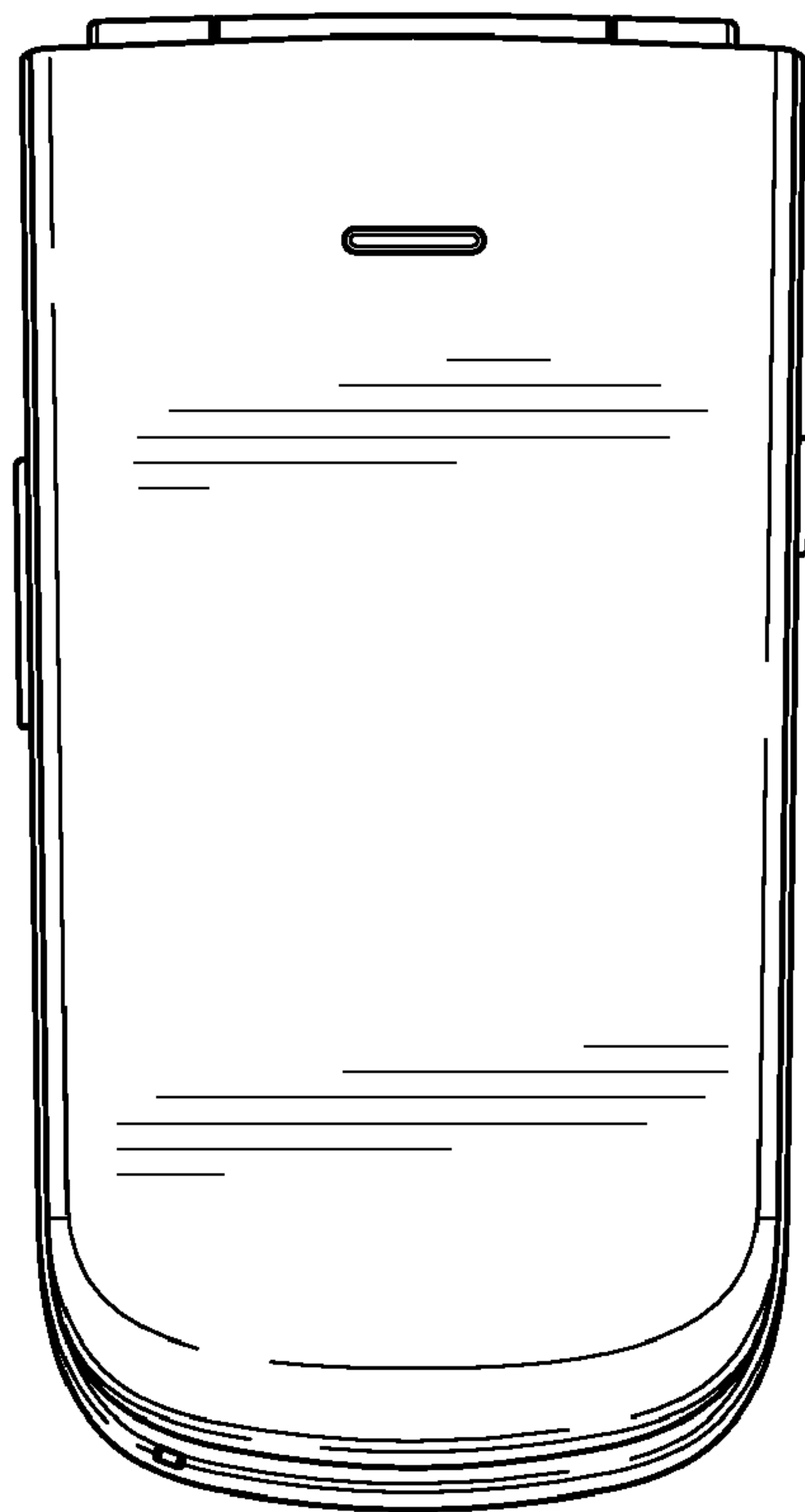

FIG. 3

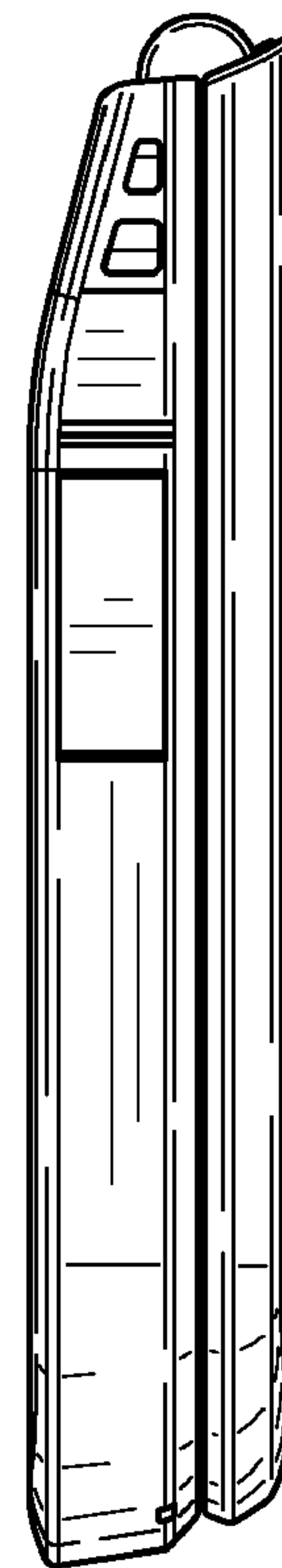

FIG. 4

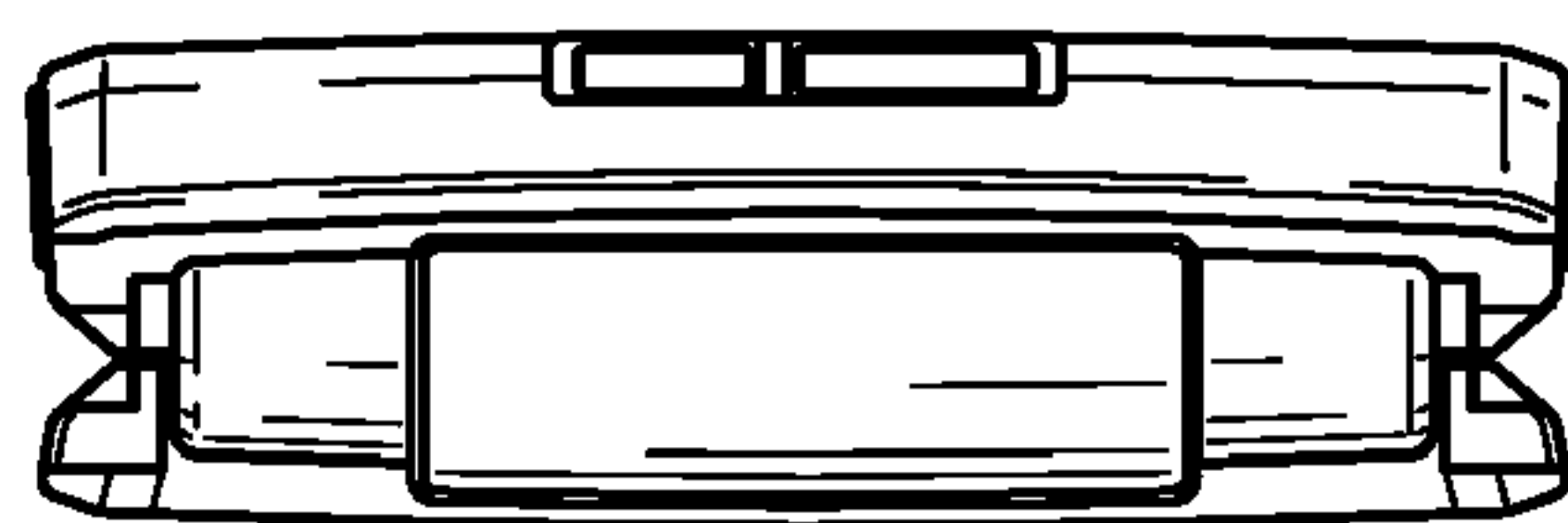

FIG. 5

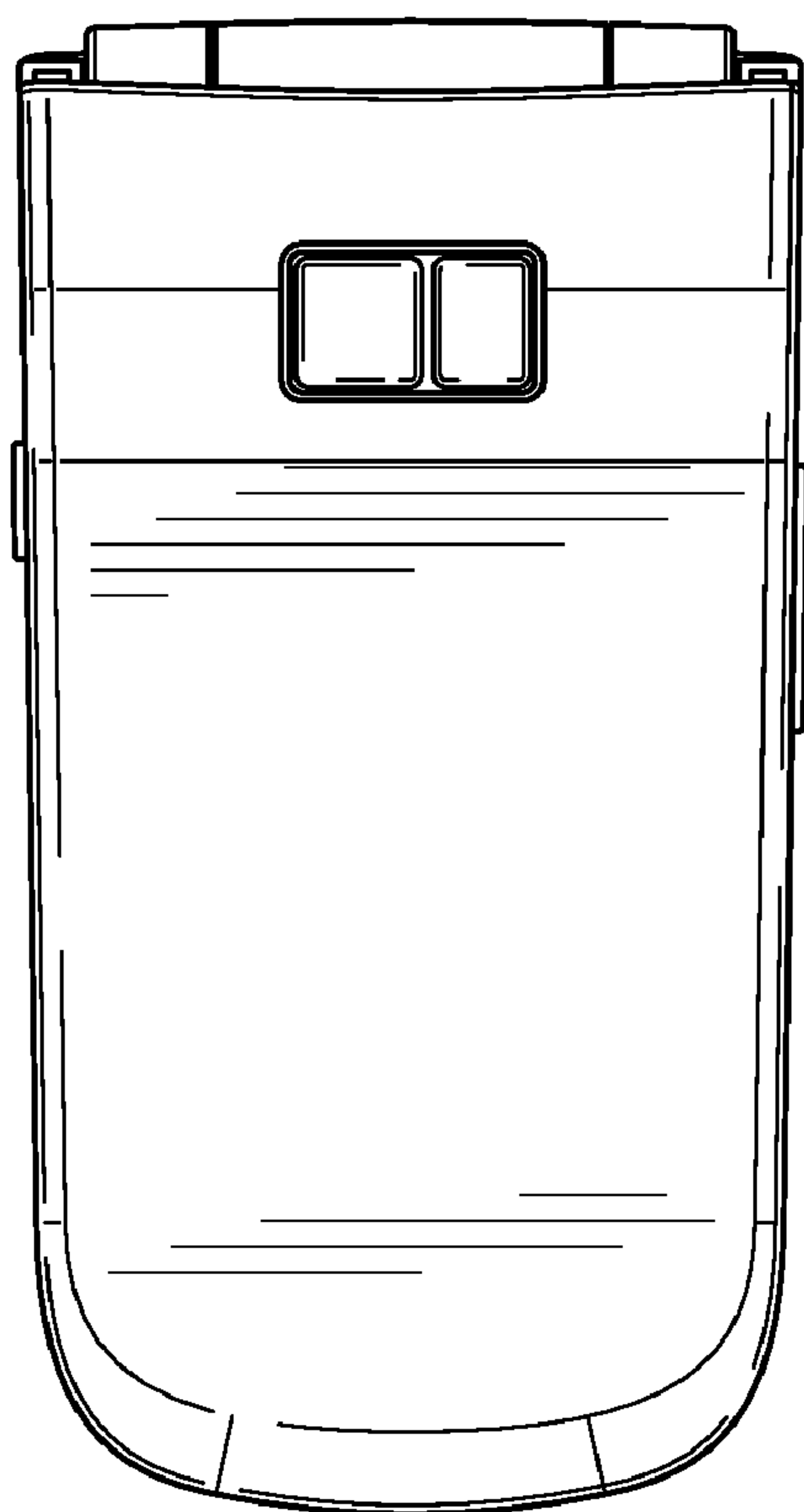

FIG. 6

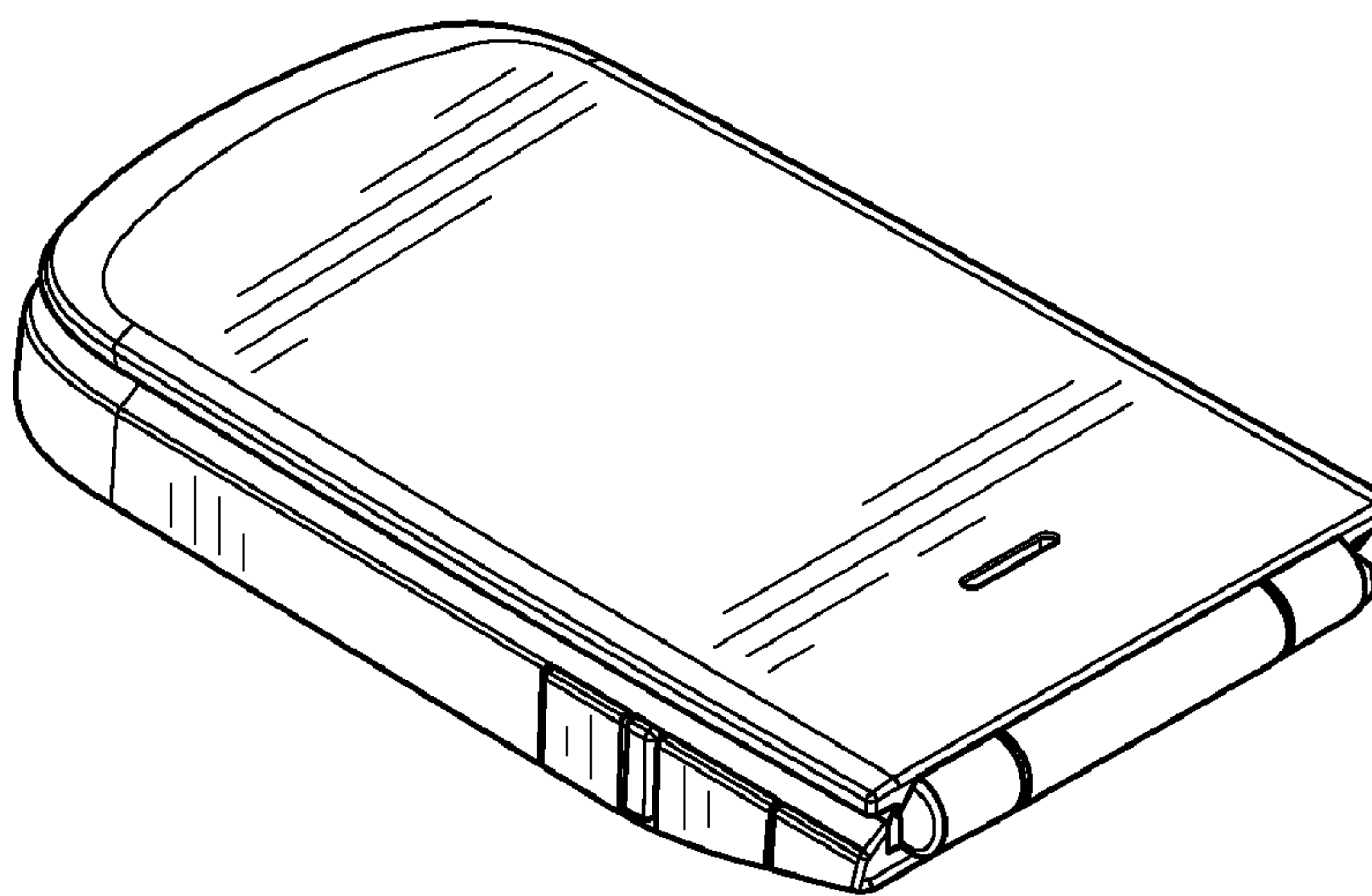

FIG. 7

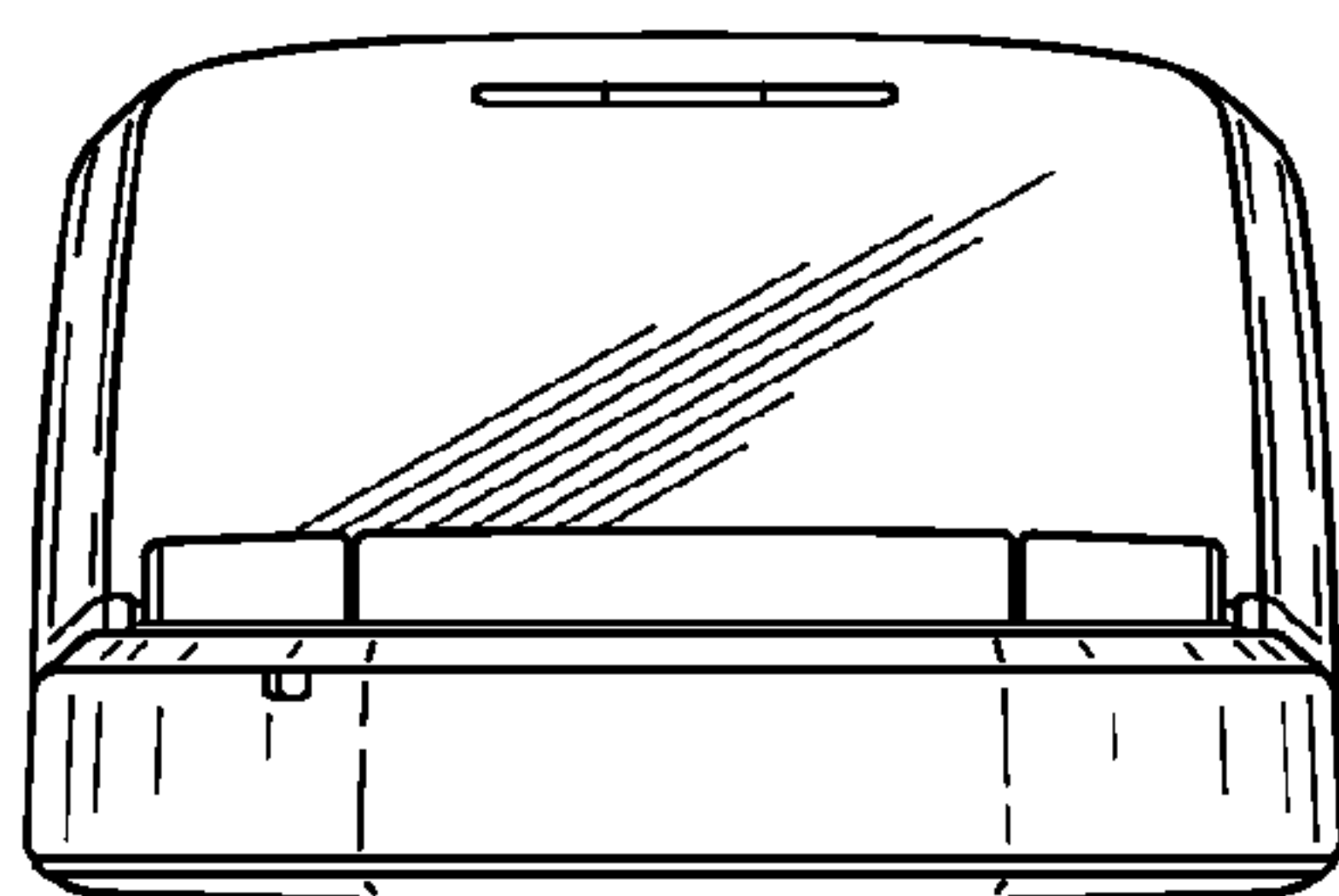

FIG. 8

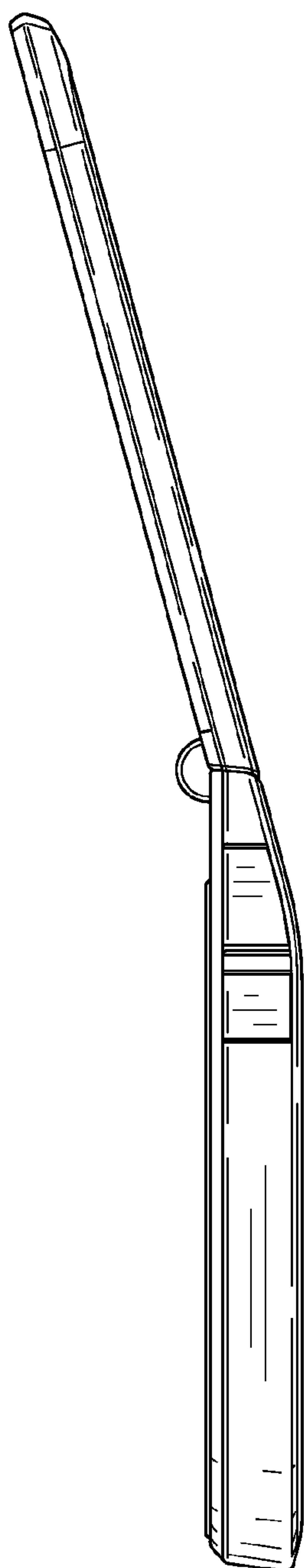

FIG. 9

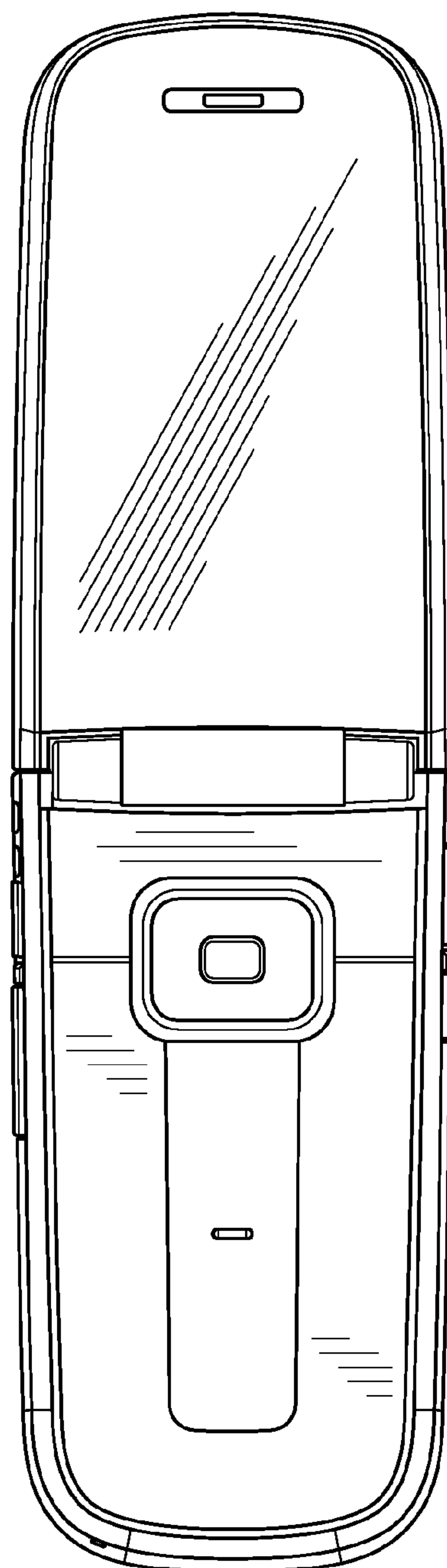

FIG. 10

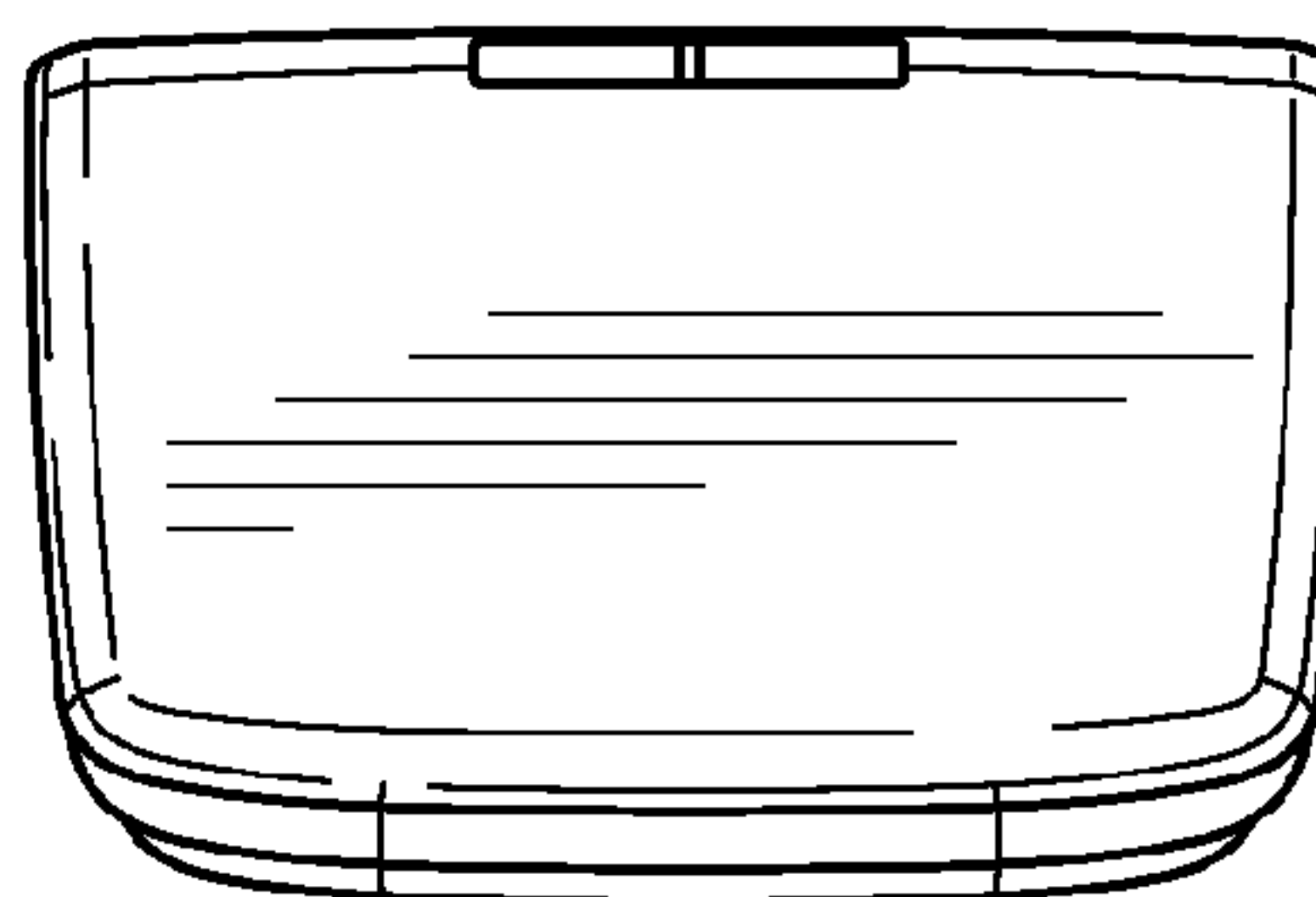

FIG. 12

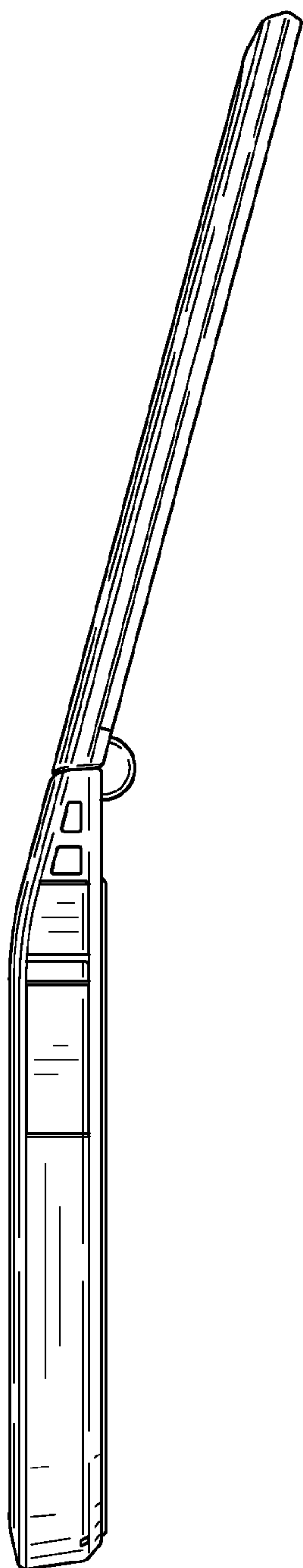

FIG. 11

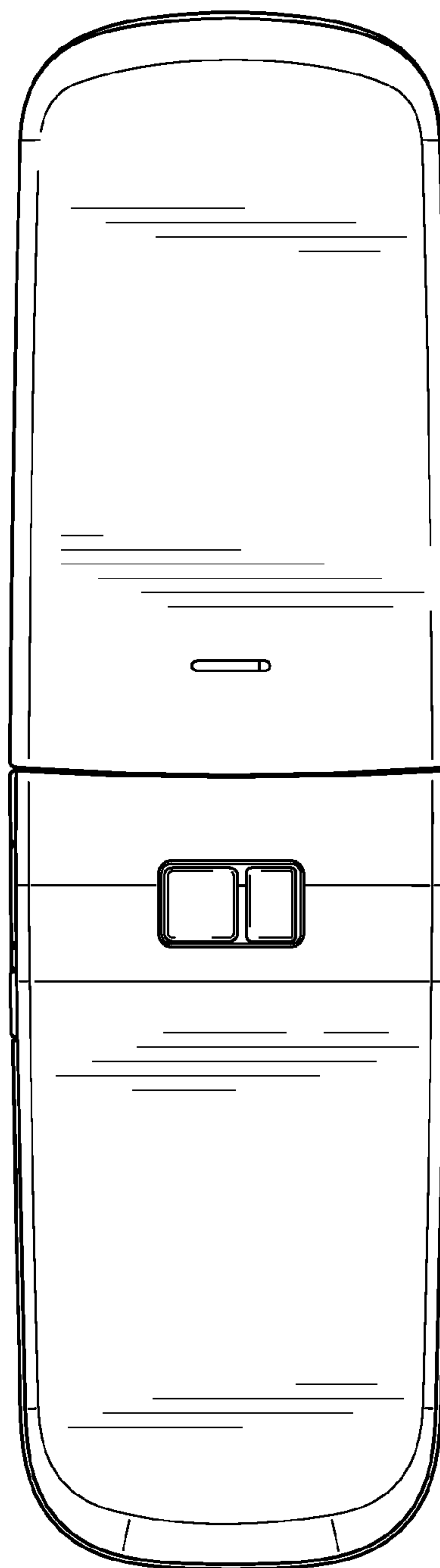

FIG. 13

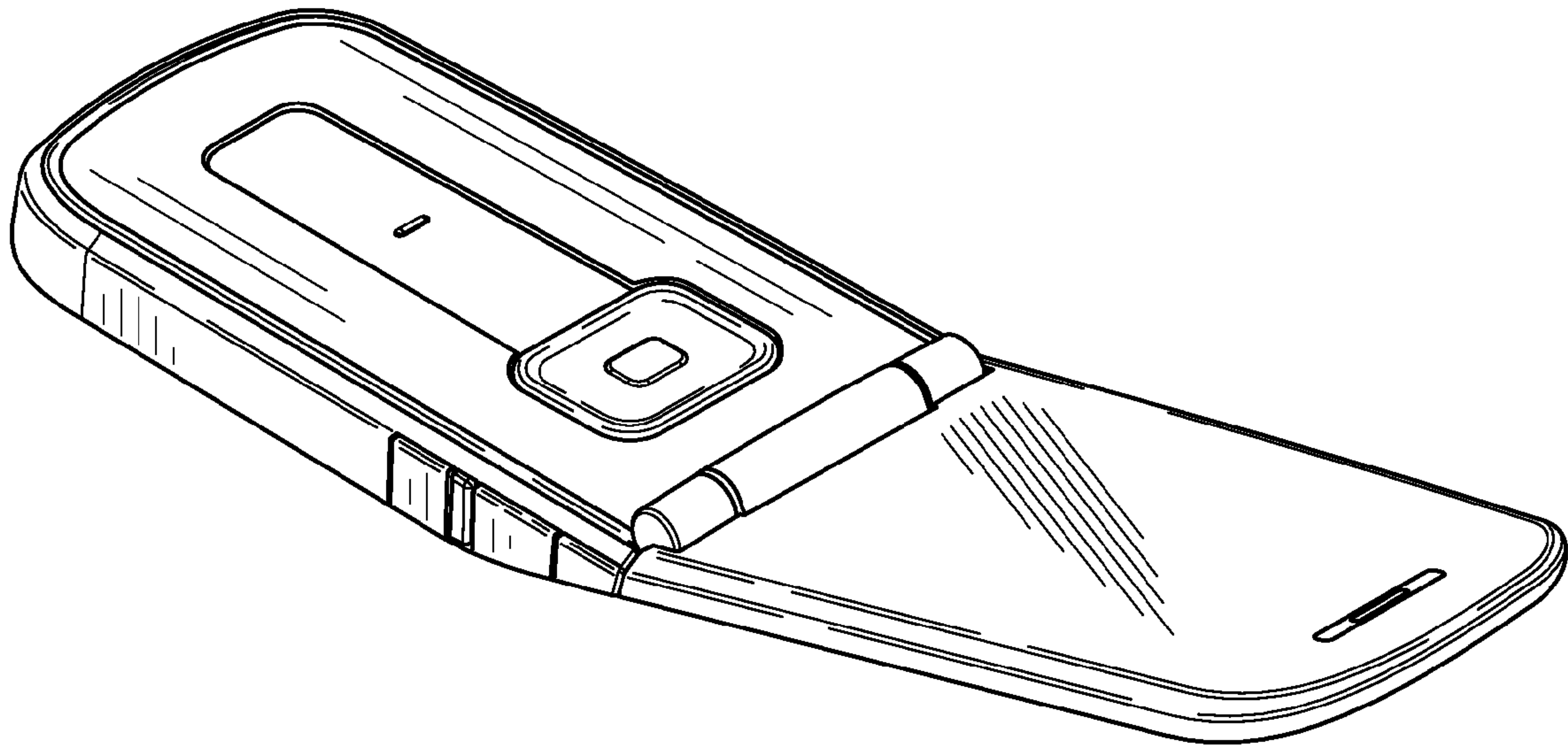

FIG. 14