



US00D589017S

(12) **United States Design Patent**  
**Kim et al.**

(10) **Patent No.:** **US D589,017 S**  
(45) **Date of Patent:** **\*\* Mar. 24, 2009**

(54) **MOBILE PHONE**  
(75) Inventors: **Joon-Suh Kim**, Anyang-si (KR);  
**Gee-Hong Yoon**, Seongnam-si (KR)  
(73) Assignee: **Samsung Electronics Co., Ltd.**,  
Suwon-Si (KR)  
(\*\*) Term: **14 Years**  
(21) Appl. No.: **29/293,585**  
(22) Filed: **Nov. 30, 2007**  
(30) **Foreign Application Priority Data**  
Oct. 9, 2007 (KR) ..... 30-2007-0041998  
(51) **LOC (9) Cl.** ..... **14-03**  
(52) **U.S. Cl.** ..... **D14/138 AD; D14/138 AA**  
(58) **Field of Classification Search** ..... D14/137,  
D14/138, 147, 191, 218, 247-248, 341-347,  
D14/496; D10/65, 78, 104; D13/168; D18/7;  
455/556.1, 566, 575.1, 575.3; 345/169  
See application file for complete search history.

(56) **References Cited**  
U.S. PATENT DOCUMENTS  
D528,095 S \* 9/2006 Kwon et al. .... D14/138  
D529,471 S \* 10/2006 Park ..... D14/138  
D531,531 S \* 11/2006 Chen ..... D10/65  
D534,143 S \* 12/2006 Lheem ..... D14/138  
D534,145 S \* 12/2006 Lheem ..... D14/138  
D535,637 S \* 1/2007 Park et al. .... D14/138  
D536,690 S \* 2/2007 Lee ..... D14/138  
D544,459 S \* 6/2007 Wang ..... D14/138  
D545,792 S \* 7/2007 Kim et al. .... D14/138  
D546,313 S \* 7/2007 Lheem ..... D14/138  
D550,190 S \* 9/2007 Minamide et al. .... D14/138  
D556,172 S \* 11/2007 Jung et al. .... D14/138  
D557,244 S \* 12/2007 Lee et al. .... D14/138  
D561,148 S \* 2/2008 Chen ..... D14/138  
D561,155 S \* 2/2008 Kim et al. .... D14/138  
D561,720 S \* 2/2008 Suk et al. .... D14/138  
D562,794 S \* 2/2008 Kim et al. .... D14/138  
D567,788 S \* 4/2008 Kim et al. .... D14/138  
D568,285 S \* 5/2008 Lee et al. .... D14/138  
D569,364 S \* 5/2008 Park et al. .... D14/138  
D569,834 S \* 5/2008 Suk et al. .... D14/138  
2003/0020694 A1 \* 1/2003 Kim et al. .... 345/169  
2004/0242288 A1 \* 12/2004 Balle et al. .... 455/575.1

2005/0014538 A1 \* 1/2005 Hyun et al. .... 455/575.4  
2007/0232361 A1 \* 10/2007 Park et al. .... 455/566  
2007/0293280 A1 \* 12/2007 Nieuwenhuizen ..... 455/575.1

**OTHER PUBLICATIONS**

Gigabyte g-Smart t600, announced Feb. 2007, [online], [retrieved on Mar. 12, 2007]. Retrieved from Internet ,<URL: http://www.gsmarena.com>.\*  
Samsung X830, announced Sep. 2006, [online], [retrieved on Feb. 8, 2007]. Retrieved from Internet ,<URL: http://www.gsmarena.com>.\*  
Samsung F500, announced Dec. 2006, [online], [retrieved on Feb. 8, 2007]. Retrieved from Internet ,<URL: http://www.gsmarena.com>.\*  
Samsung F210, announced Jun. 2007, [online], [retrieved on Aug. 6, 2007]. Retrieved from Internet ,<URL: http://www.gsmarena.com>.\*  
Sharp TM100, announced 1<sup>st</sup> quarter 2004, [online], [retrieved on Feb. 20, 2007]. Retrieved from Internet ,<URL: http://www.gsmarena.com>.\*

\* cited by examiner

*Primary Examiner*—Jeffrey D Asch  
*Assistant Examiner*—Bridget L Eland  
(74) *Attorney, Agent, or Firm*—Staas & Halsey LLP

(57) **CLAIM**

The ornamental design for a mobile phone, as shown and described.

**DESCRIPTION**

FIG. 1 is a perspective view of a mobile phone;  
FIG. 2 is a front view of the mobile phone of FIG. 1;  
FIG. 3 is a rear view of the mobile phone of FIG. 1;  
FIG. 4 is a left-side view of the mobile phone of FIG. 1;  
FIG. 5 is a right-side view of the mobile phone of FIG. 1;  
FIG. 6 is a top plan view of the mobile phone of FIG. 1;  
FIG. 7 is a bottom plan view of the mobile phone of FIG. 1;  
and,  
FIG. 8 is a perspective view of the mobile phone of FIG. 3.

**1 Claim, 6 Drawing Sheets**

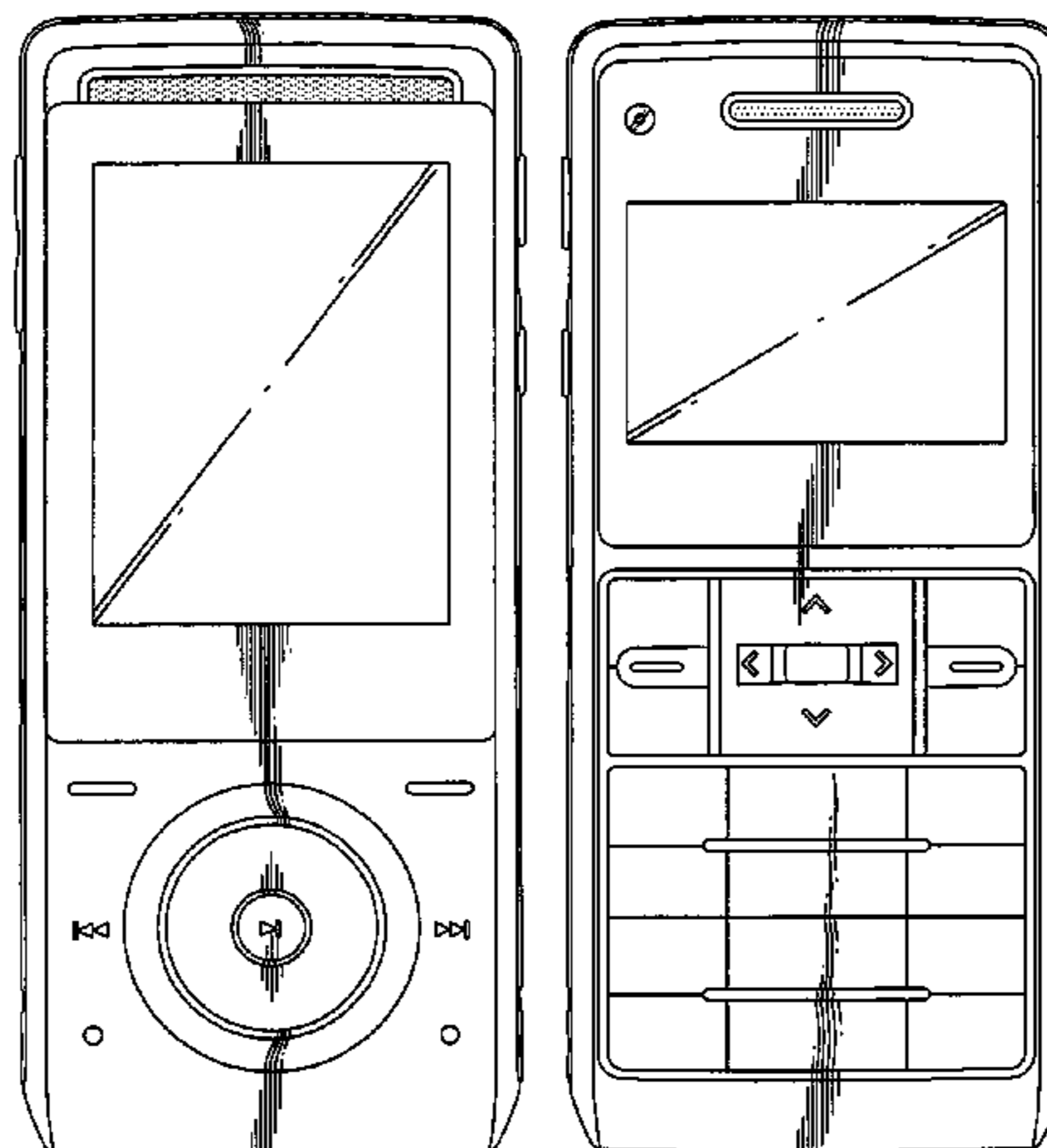

FIG. 1

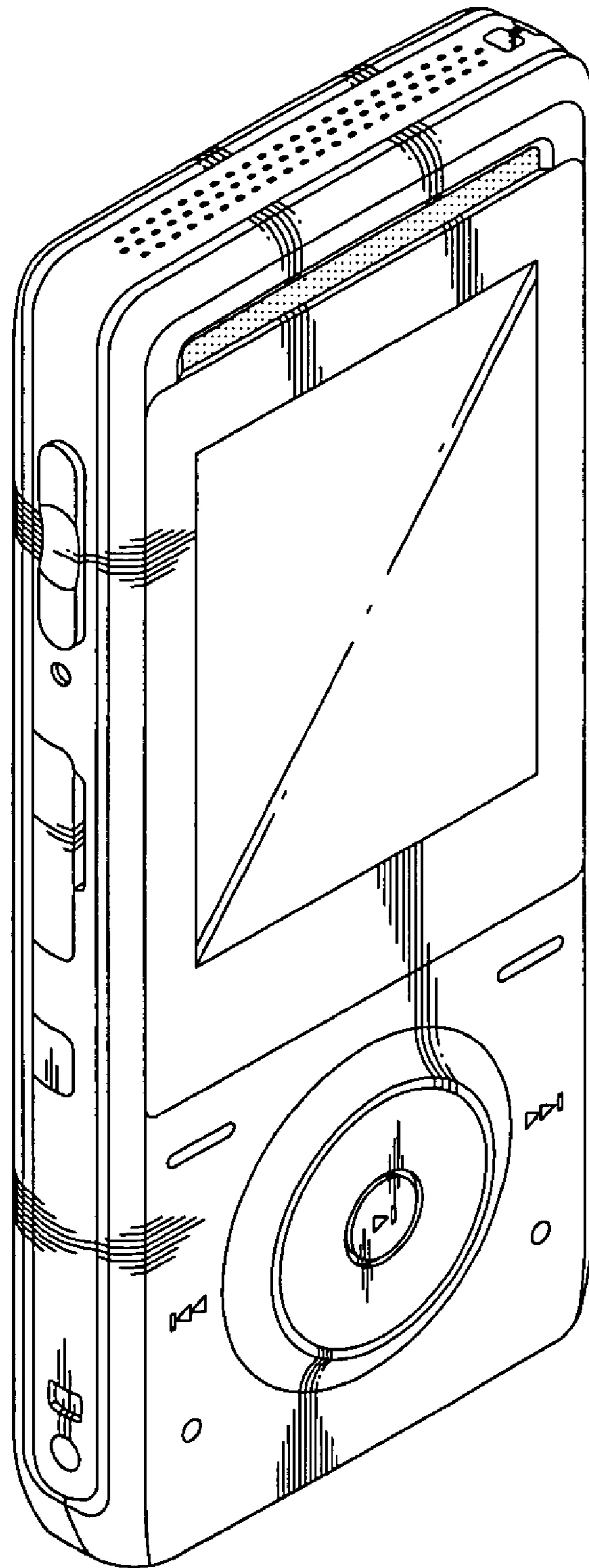

FIG. 2

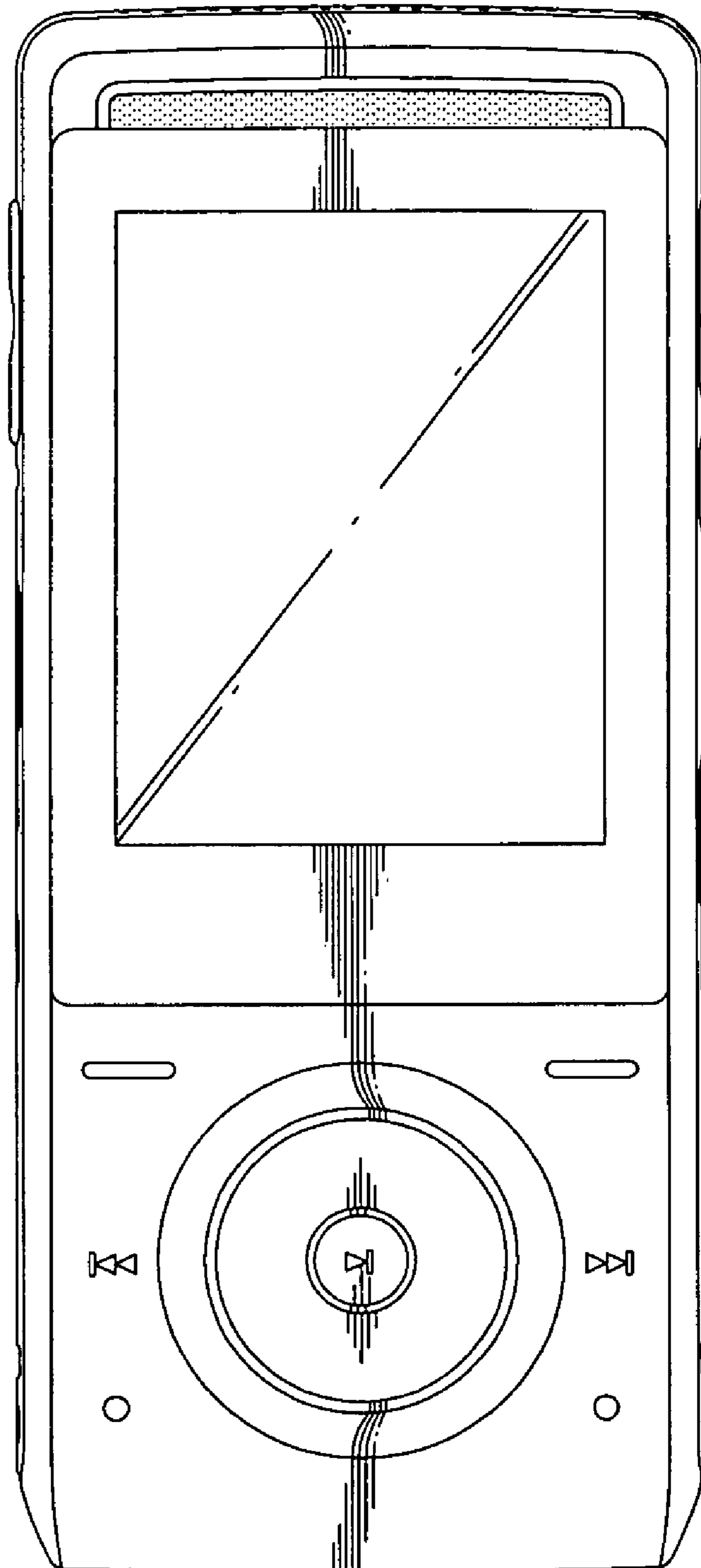

FIG. 3

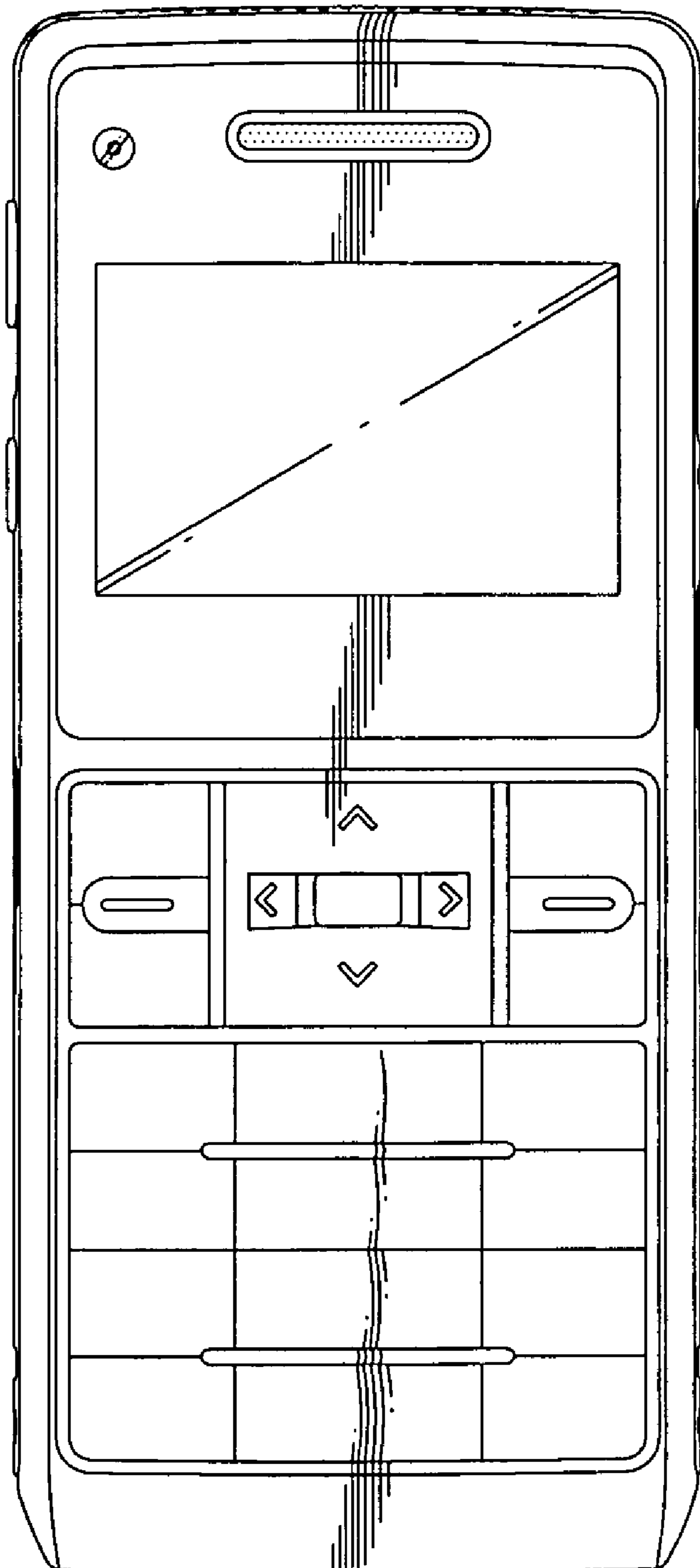

FIG. 4

FIG. 5

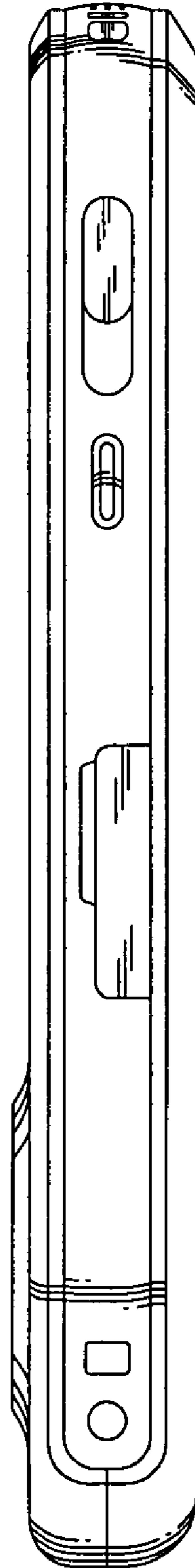
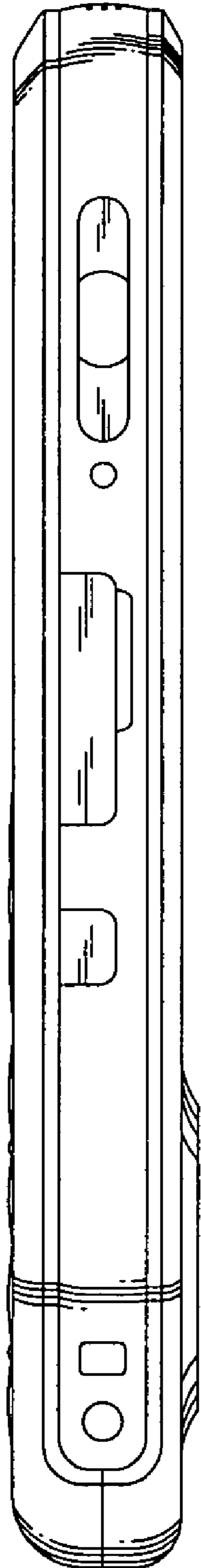

FIG. 6

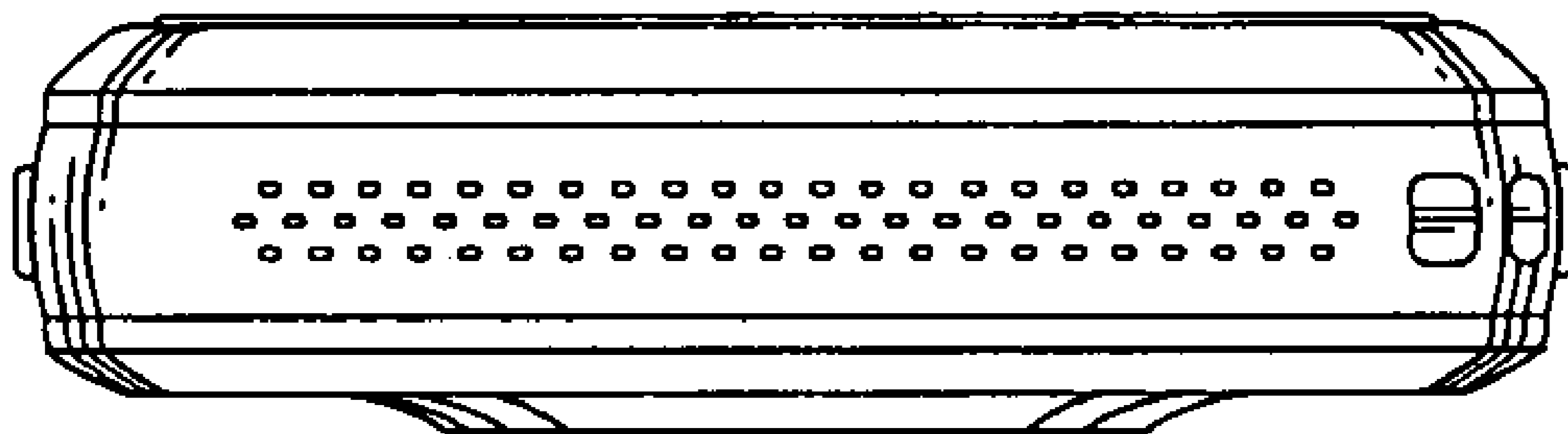

FIG. 7

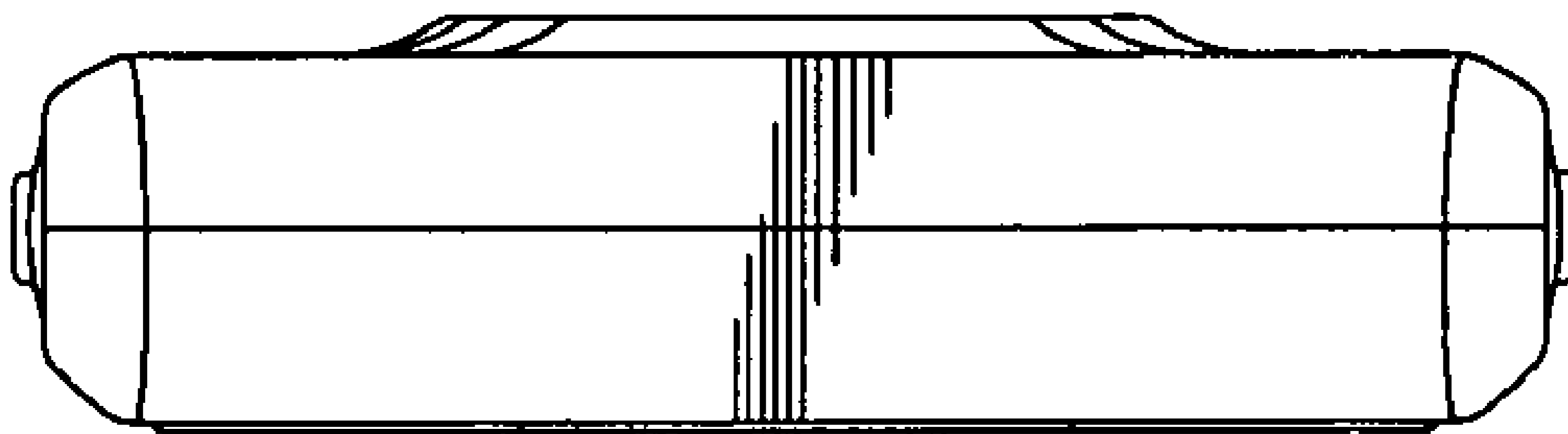

FIG. 8

