



US00D589012S

(12) **United States Design Patent**
Soyano et al.

(10) **Patent No.:** **US D589,012 S**
(45) **Date of Patent:** **** Mar. 24, 2009**

- (54) **SEMICONDUCTOR DEVICE**
- (75) Inventors: **Shin Soyano**, Tokyo (JP); **Akira Nishiura**, Tokyo (JP)
- (73) Assignee: **Fuji Electric Device Technology Co., Ltd.**, Tokyo (JP)
- (**) Term: **14 Years**
- (21) Appl. No.: **29/319,980**
- (22) Filed: **Jun. 18, 2008**
- (30) **Foreign Application Priority Data**
Mar. 17, 2008 (JP) 2008-006506
- (51) **LOC (9) Cl.** **13-03**
- (52) **U.S. Cl.** **D13/182**
- (58) **Field of Classification Search** D13/110,
D13/182; 257/690; 324/754, 755, 765; 361/713,
361/728, 736, 775
See application file for complete search history.

- 5,761,040 A * 6/1998 Iwasa et al. 361/704
- D396,450 S * 7/1998 Nishiura et al. D13/182
- 5,956,231 A * 9/1999 Yamada et al. 361/728
- 6,448,803 B1 * 9/2002 Chung 324/765
- D476,959 S * 7/2003 Yamada et al. D13/182
- 6,720,783 B2 * 4/2004 Satoh et al. 324/755
- 7,053,640 B2 * 5/2006 Feld et al. 324/755
- 7,443,692 B2 * 10/2008 Patwardhan et al. 361/775
- 2002/0093352 A1 * 7/2002 Min et al. 324/754
- 2007/0126445 A1 * 6/2007 Stutzman et al. 324/755

* cited by examiner

Primary Examiner—Selina Sikder
(74) *Attorney, Agent, or Firm*—Young & Thompson

(57) **CLAIM**

The ornamental design for semiconductor device, as shown and described.

DESCRIPTION

FIG. 1 is a perspective view of the front, right and bottom of semiconductor device showing our new design;

FIG. 2 is a front view thereof;

FIG. 3 is a rear view thereof;

FIG. 4 is a left side view thereof;

FIG. 5 is a right side view thereof;

FIG. 6 is a top plan view thereof; and,

FIG. 7 is a bottom view thereof.

1 Claim, 3 Drawing Sheets

- (56) **References Cited**
U.S. PATENT DOCUMENTS
- 4,218,724 A * 8/1980 Kaufman 361/736
- 4,630,174 A * 12/1986 Kaufman 361/713
- D357,672 S * 4/1995 Terasawa et al. D13/182
- D389,808 S * 1/1998 Yamada et al. D13/182
- 5,742,171 A * 4/1998 Matsunaga et al. 324/755

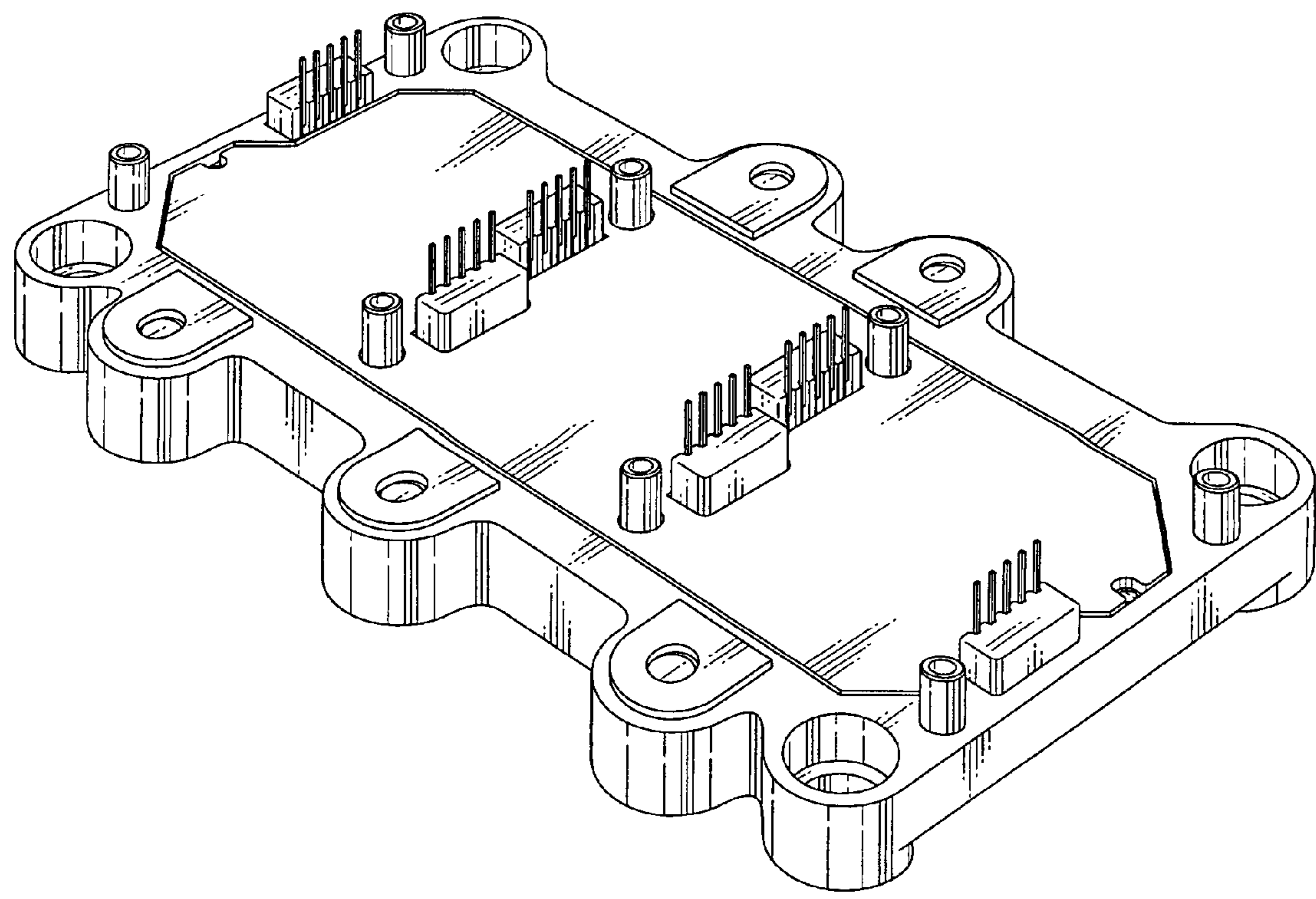

FIG.1

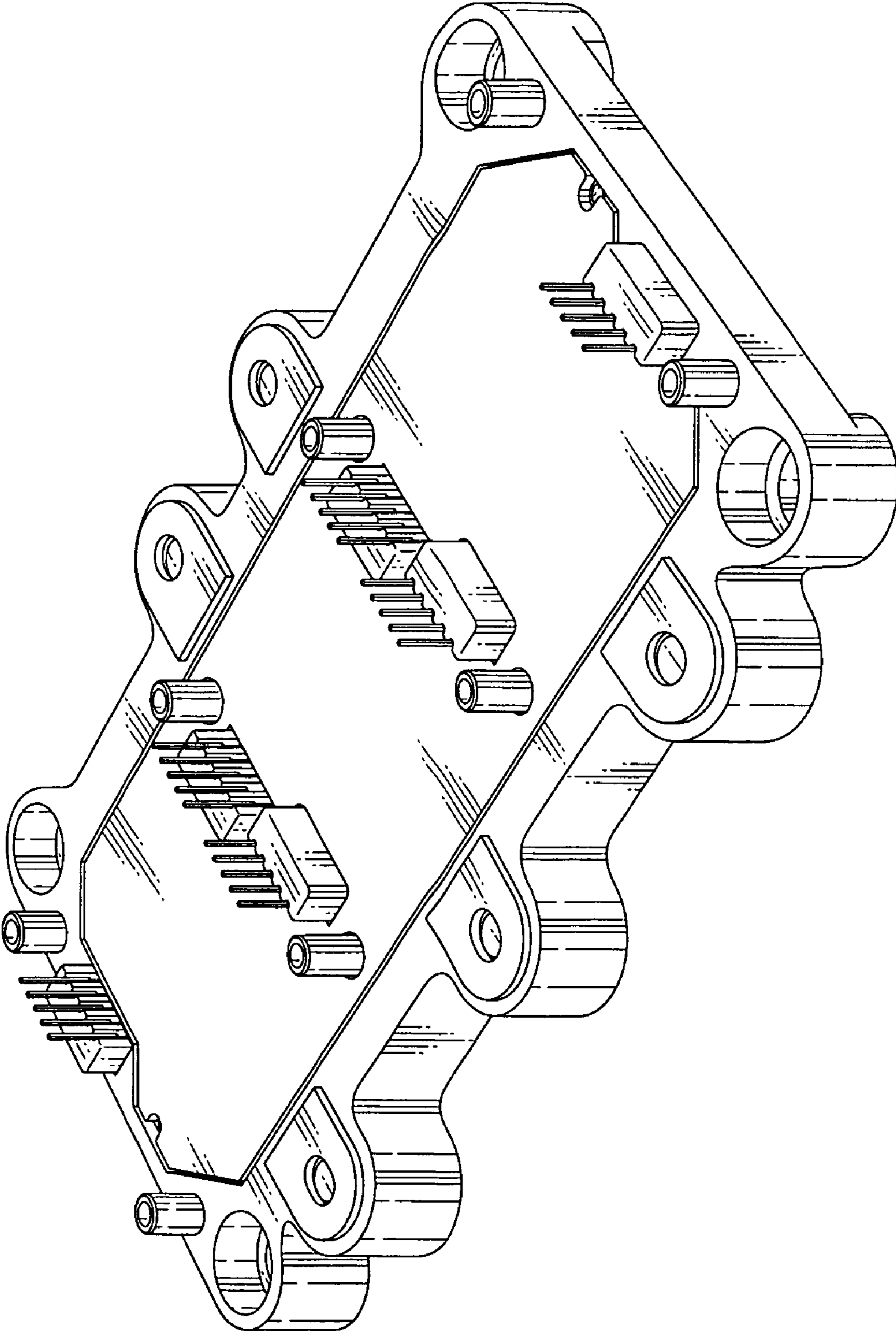

FIG.2

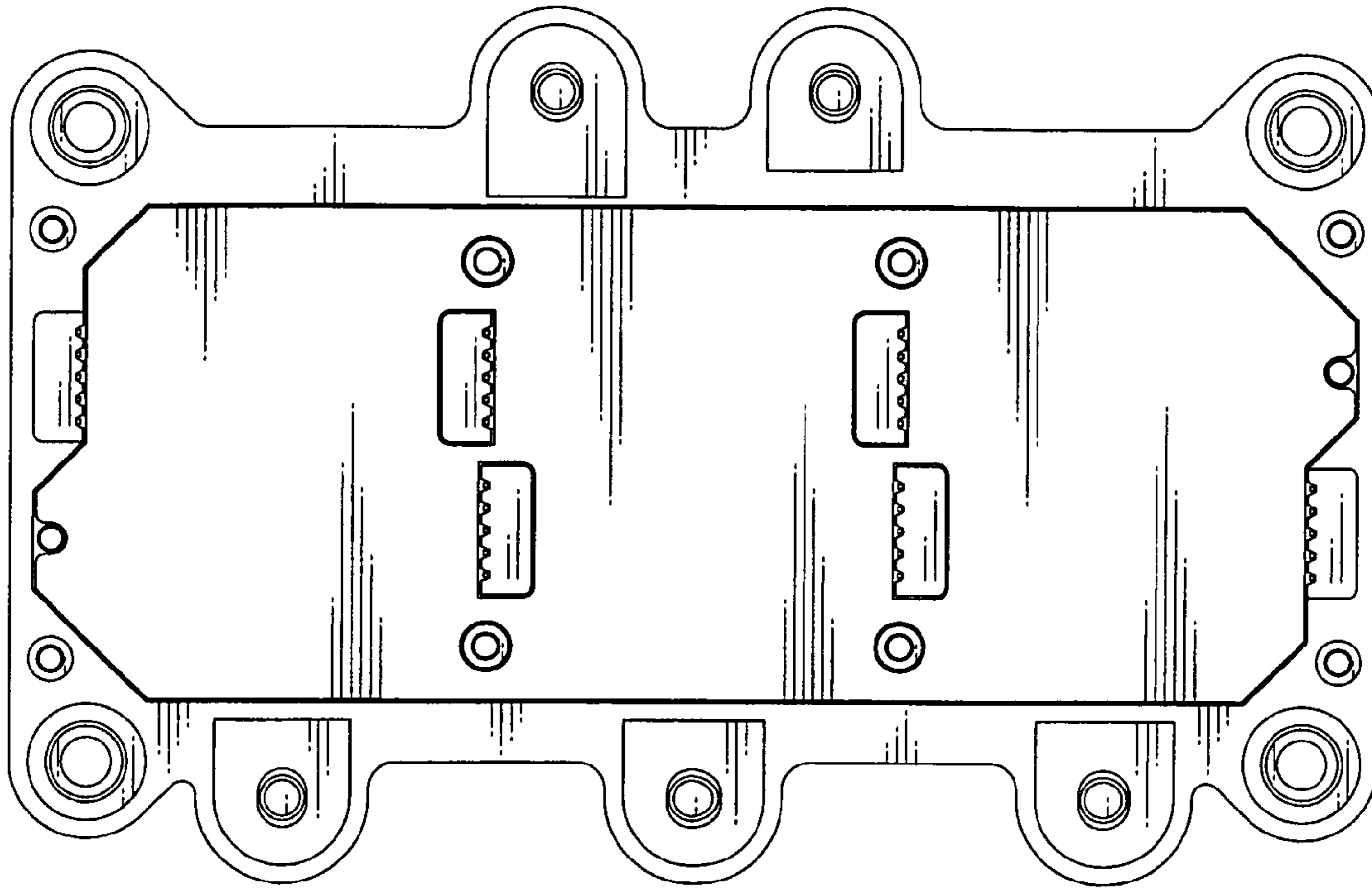

FIG.3

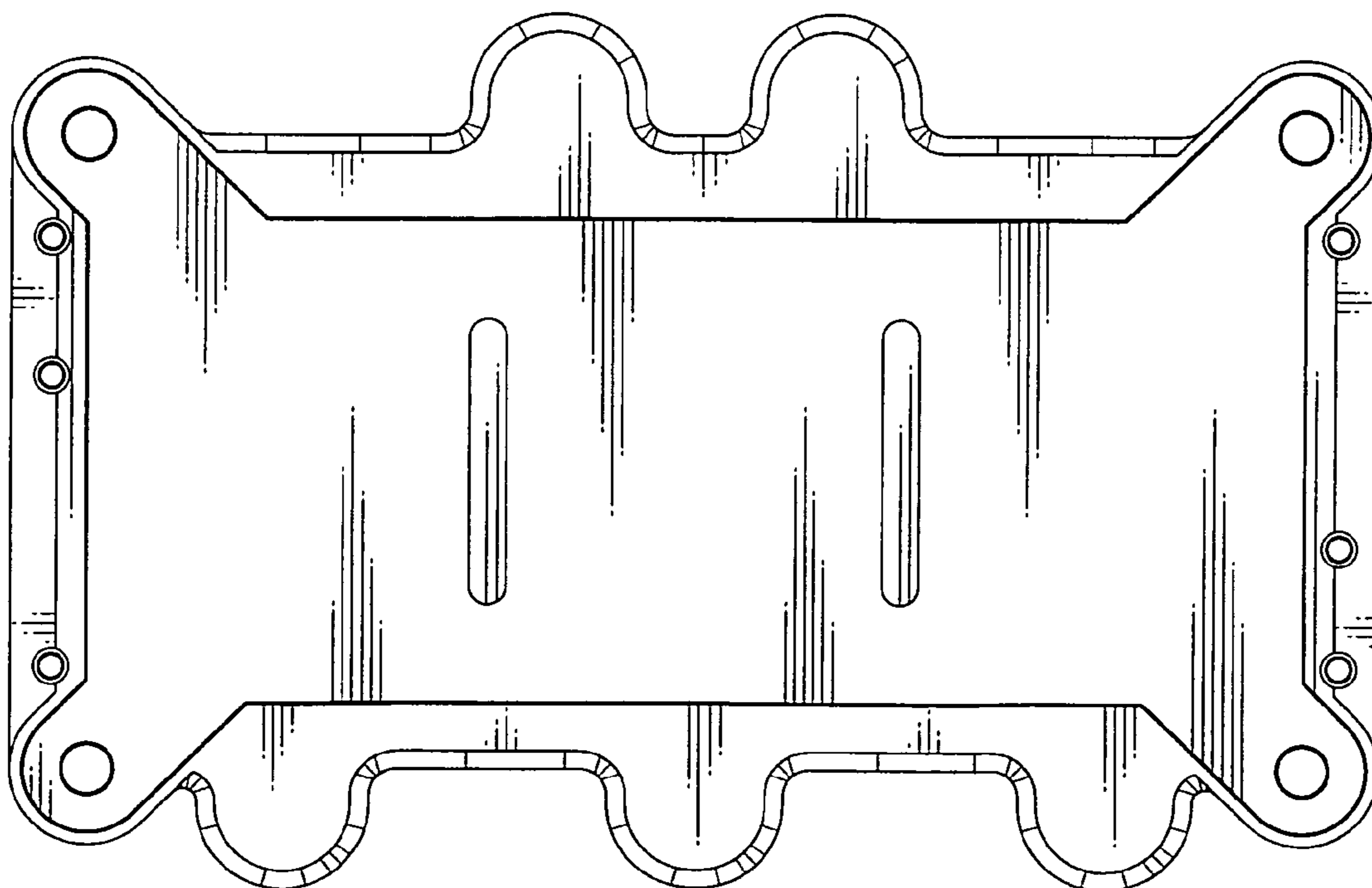

FIG.4

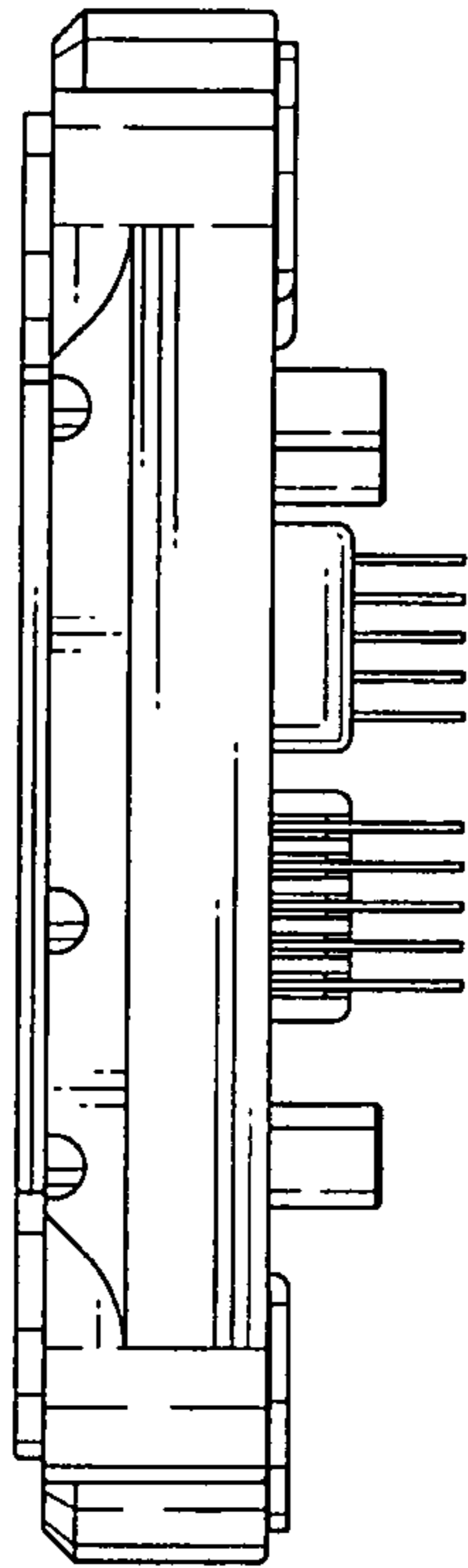

FIG.5

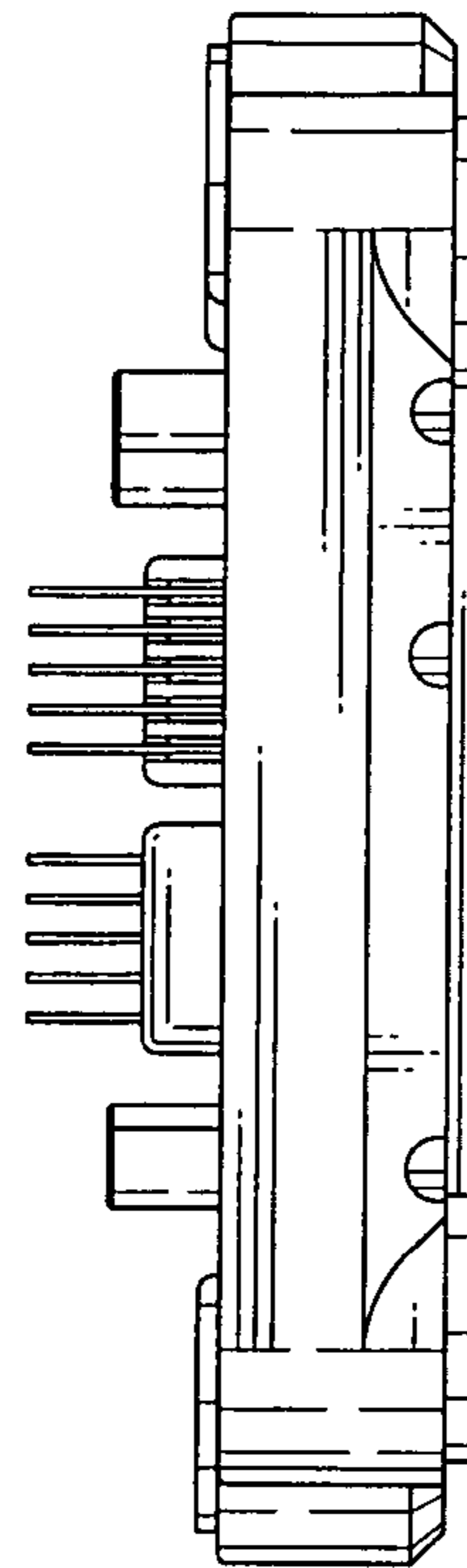

FIG.6

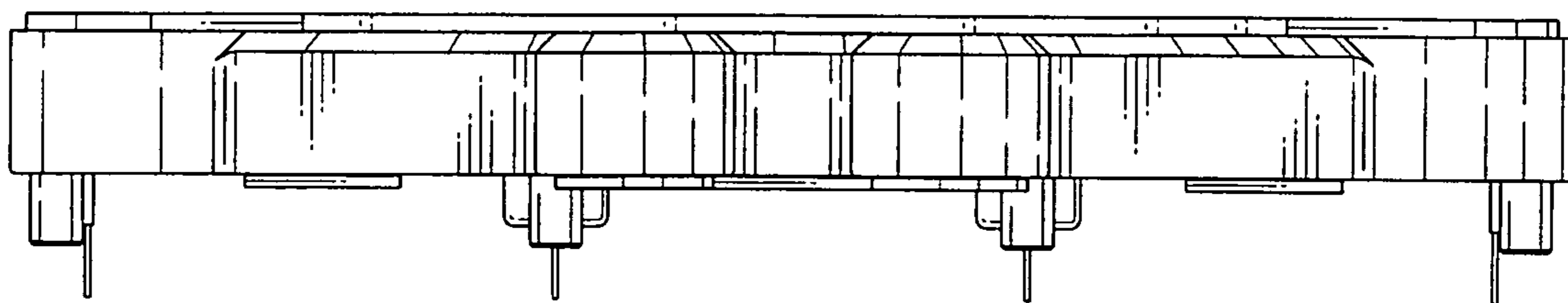

FIG.7

