



US00D588930S

(12) **United States Design Patent**
Künz

(10) **Patent No.:** **US D588,930 S**

(45) **Date of Patent:** **** Mar. 24, 2009**

(54) **TUBE**

(75) Inventor: **Johann Künz**, Hard (AT)

(73) Assignee: **Alpla Werke Alwin Lehner GmbH & Co. KG**, Hard (AT)

(**) Term: **14 Years**

(21) Appl. No.: **29/301,688**

(22) Filed: **Mar. 12, 2008**

(51) **LOC (9) Cl.** **09-03**

(52) **U.S. Cl.** **D9/697**

(58) **Field of Classification Search** D9/695-699,
D9/711, 521, 544, 435, 440, 454, 723-724,
D9/442, 447, 504, 727-728; 222/92, 107,
222/215, 527-529, 491; 206/822-823; D28/7,
D28/76, 82; 220/DIG. 7

See application file for complete search history.

(56) **References Cited**

U.S. PATENT DOCUMENTS

D126,431 S *	4/1941	Deskey	D9/697
D212,412 S *	10/1968	Hanlon	D9/697
D281,055 S *	10/1985	Dombroski	D9/697
4,598,839 A *	7/1986	Dombroski et al.	222/92
D319,178 S *	8/1991	Katada et al.	D9/617
D338,397 S *	8/1993	Sun et al.	D9/697
D383,383 S *	9/1997	Prestia et al.	D9/521
5,816,451 A *	10/1998	Renault	222/215

D436,029 S *	1/2001	Jones et al.	D9/699
D454,780 S *	3/2002	Leboeuf et al.	D9/697
D532,701 S *	11/2006	Spencer	D9/699
D558,061 S *	12/2007	Py et al.	D9/695
D568,171 S *	5/2008	Kawashima	D9/699

* cited by examiner

Primary Examiner—Caron Veynar

Assistant Examiner—Abraham Bahta

(74) *Attorney, Agent, or Firm*—Morriss O’Bryant Compagni, P.C.

(57) **CLAIM**

The ornamental design for a tube, as shown and described.

DESCRIPTION

FIG. 1 is a perspective front side view of a tube of the present invention;

FIG. 2 is front side view of the tube;

FIG. 3 is a back side view of the tube;

FIG. 4 is a right side view of the tube;

FIG. 5 is a left side view of the tube;

FIG. 6 is a top side view of the tube; and,

FIG. 7 is a bottom side view of the tube.

Portions shown in dashed lines do not form part of the claimed invention.

1 Claim, 7 Drawing Sheets

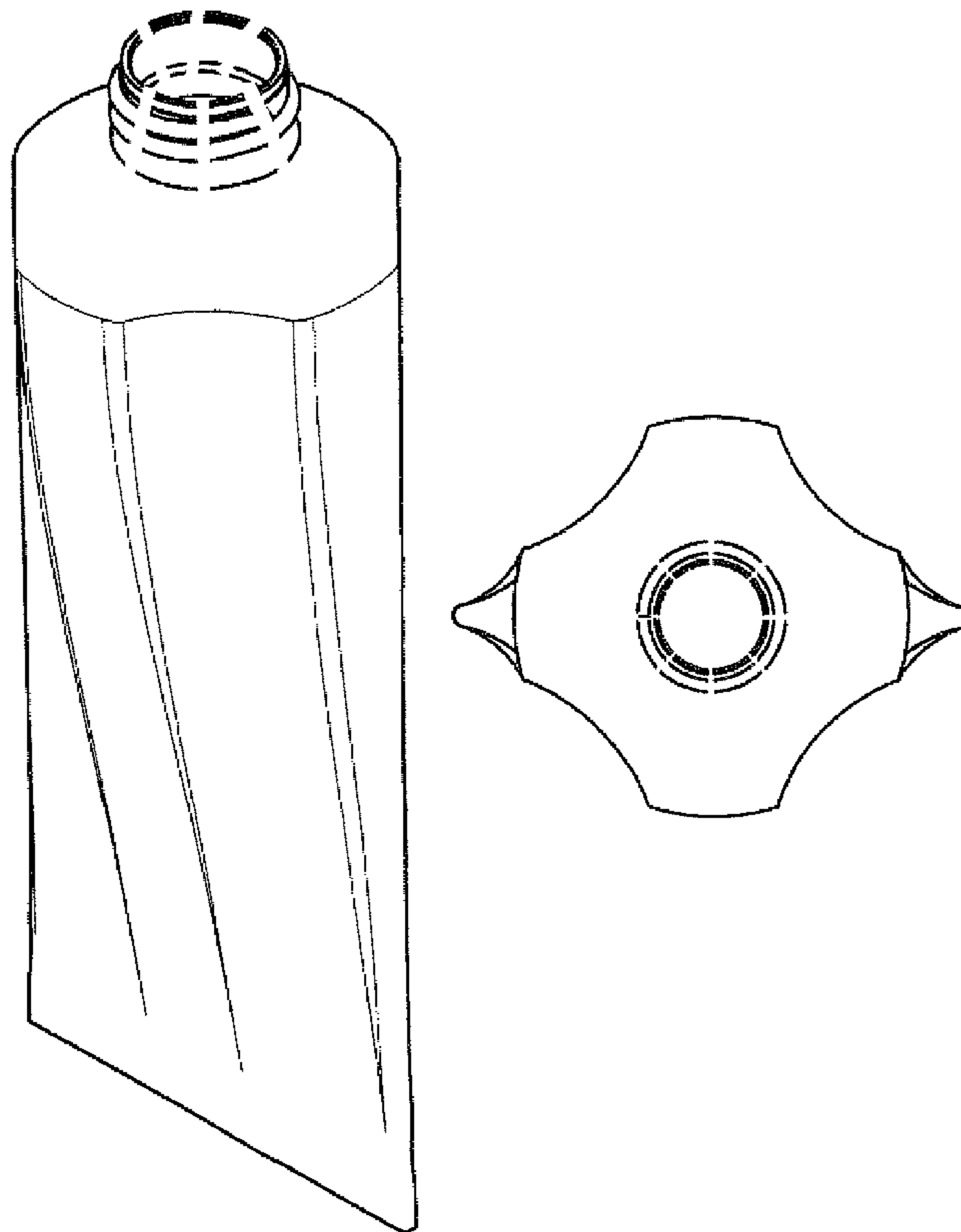

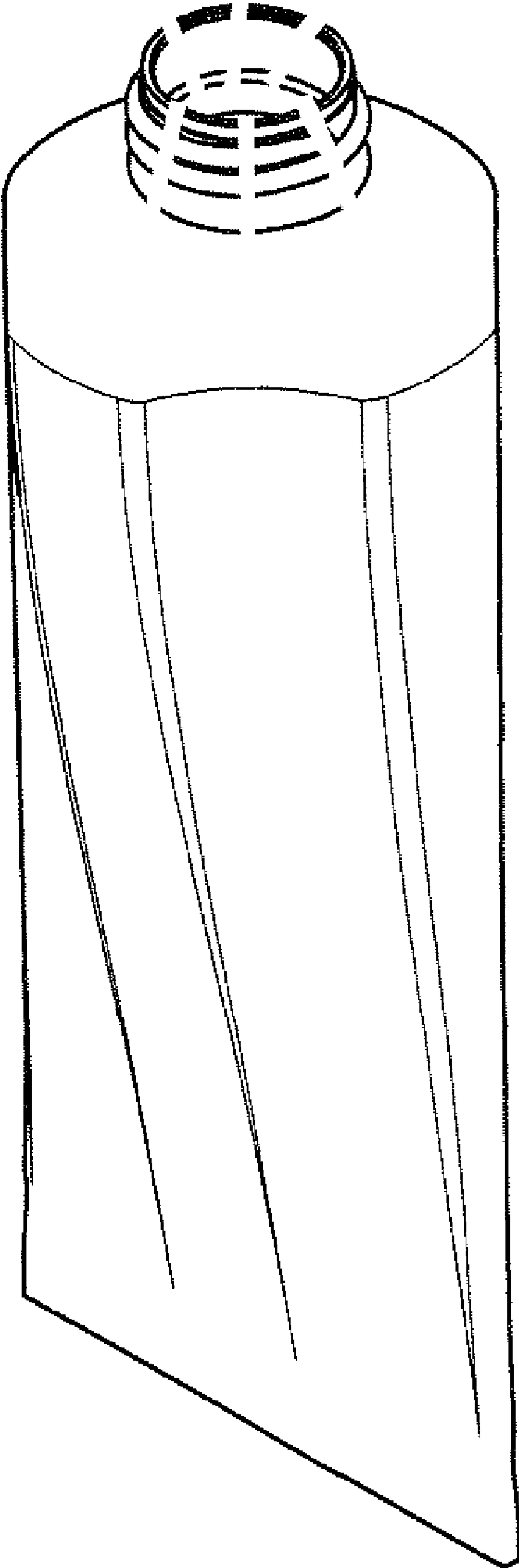

FIG. 1

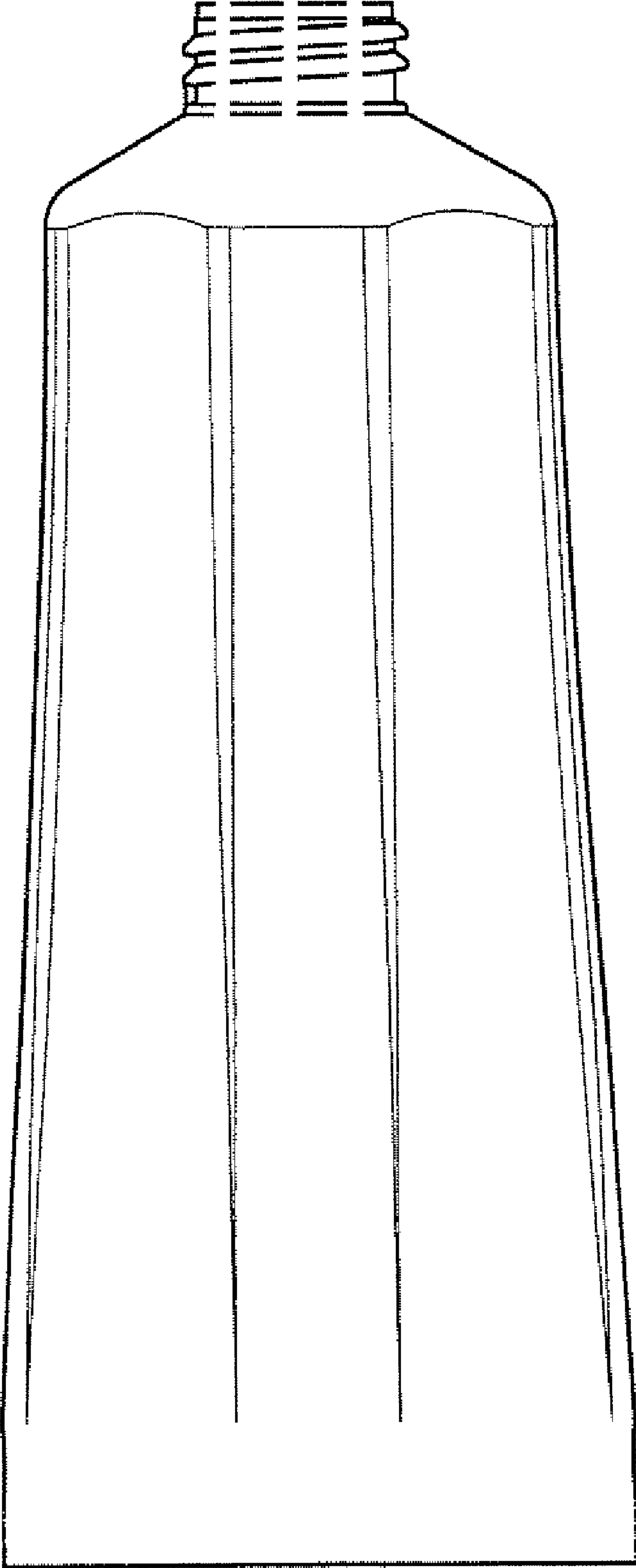

FIG. 2

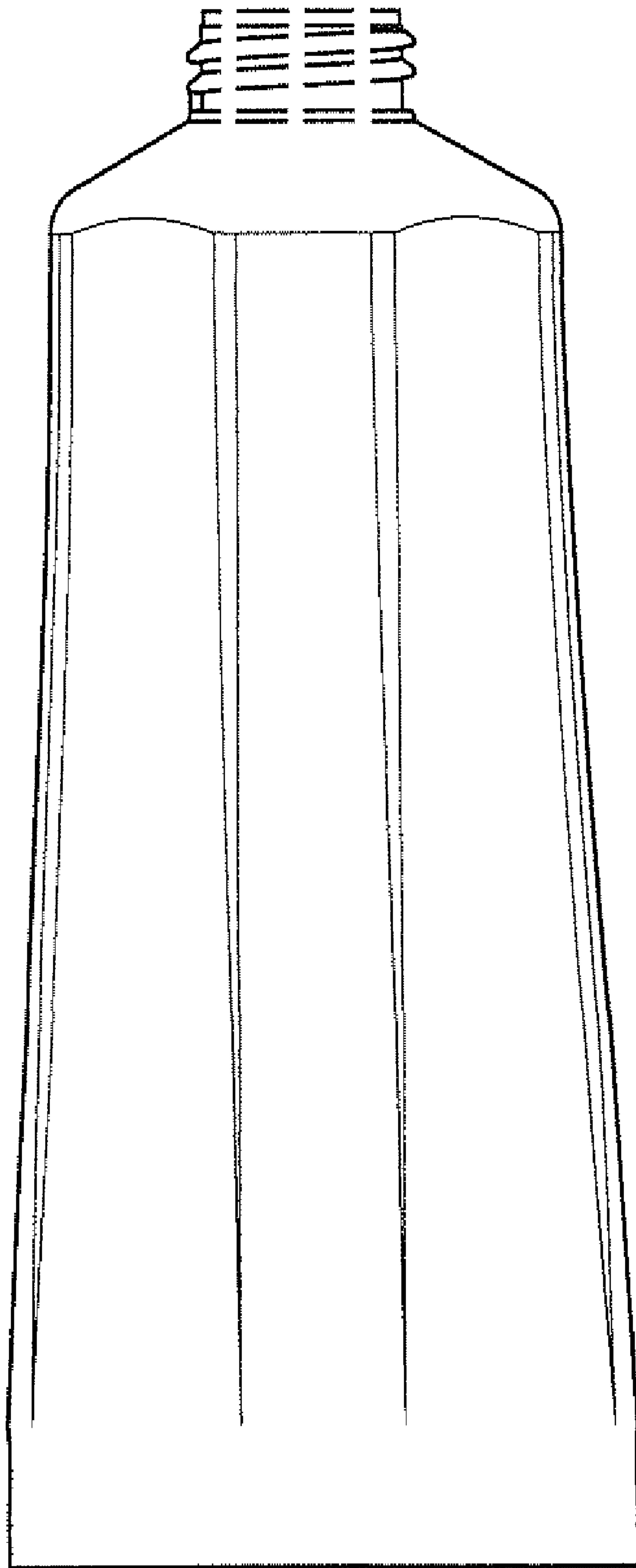

FIG. 3

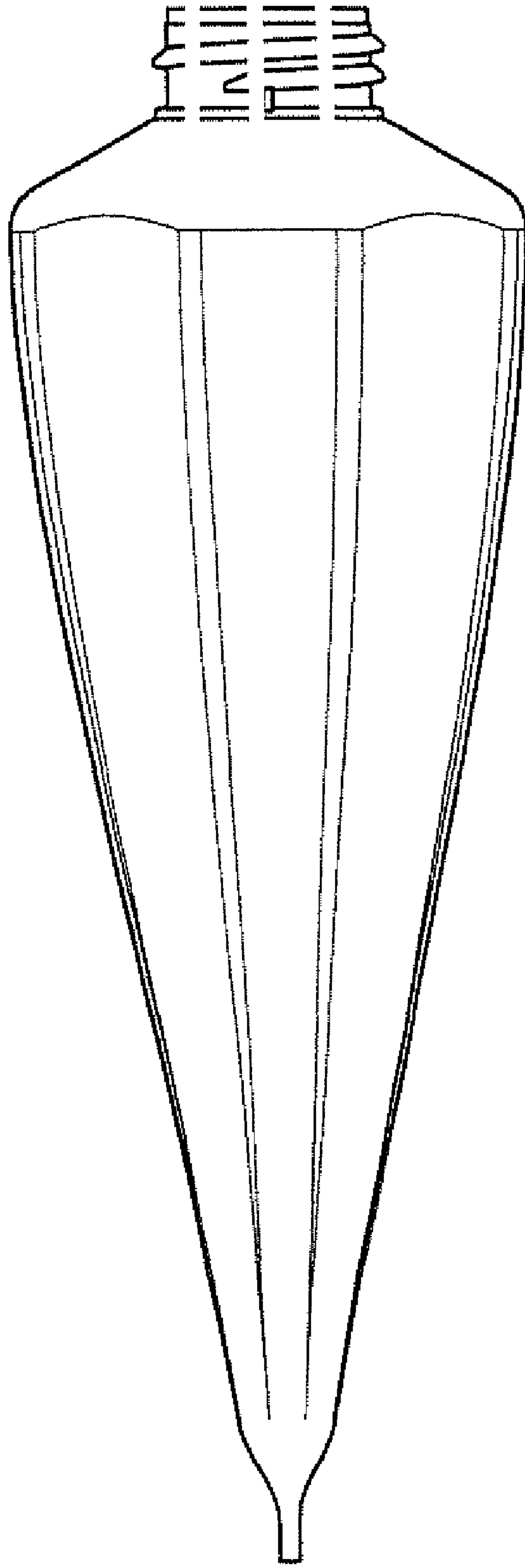

FIG. 4

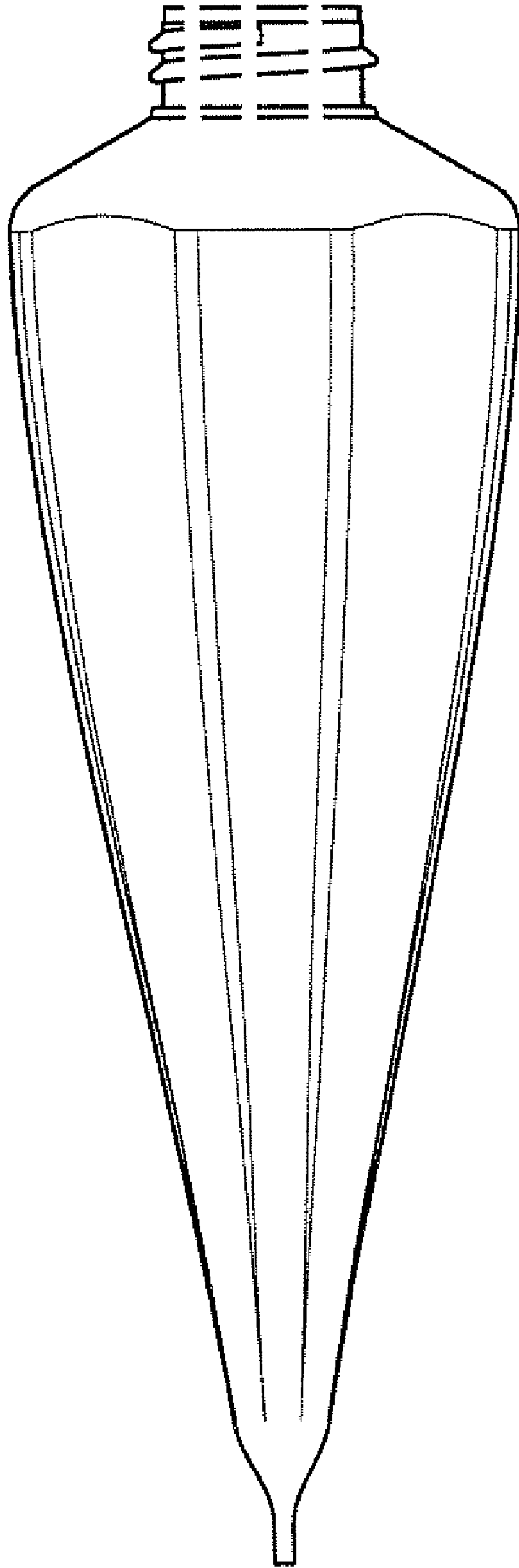

FIG. 5

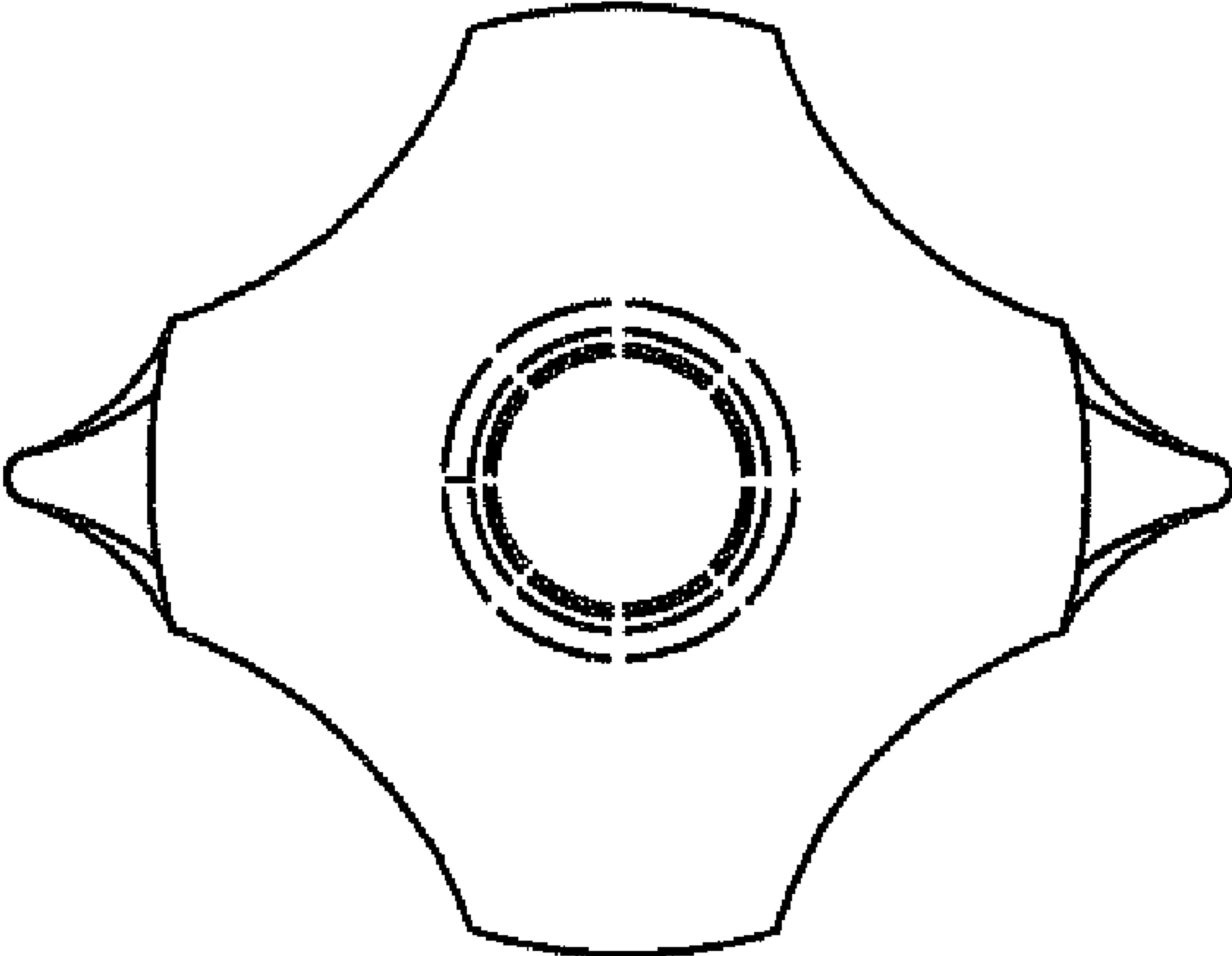

FIG. 6

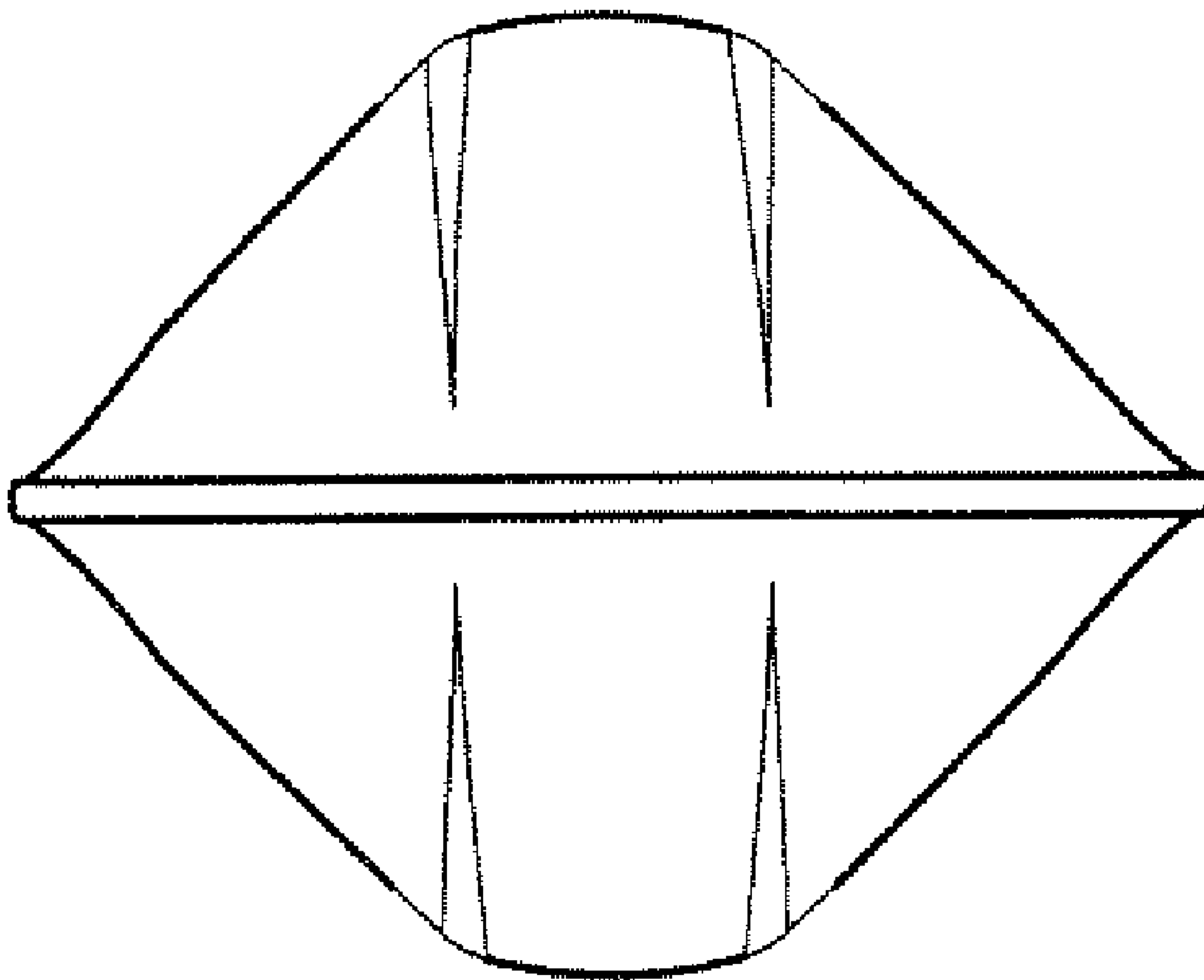

FIG. 7