



US00D588759S

(12) **United States Design Patent**  
**Spiegel**

(10) **Patent No.:** **US D588,759 S**  
(45) **Date of Patent:** **\*\* Mar. 17, 2009**

(54) **VACUUM CLEANER**

(75) Inventor: **Peter Spiegel**, Lake Balboa, CA (US)

(73) Assignee: **Sylmark Holdings Limited** (IE)

(\*\*) Term: **14 Years**

(21) Appl. No.: **29/305,220**

(22) Filed: **Mar. 14, 2008**

(51) **LOC (9) Cl.** ..... **15-05**

(52) **U.S. Cl.** ..... **D32/22**

(58) **Field of Classification Search** ..... D32/22,  
D32/30-31; 15/320, 329, 335, 340.2, 347,  
15/350-353, 361, 363, 410, 412, 414, 327.1,  
15/327.2, 327.4, 327.6, 415.1, 411; 55/345,  
55/DIG. 3, 336, 337, 429, 343, 433, 418;  
95/271; 301/7, 63.101; 280/78, 47.31, 205  
See application file for complete search history.

(56) **References Cited**

**U.S. PATENT DOCUMENTS**

D346,052 S \* 4/1994 Saunders et al. .... D32/22  
D429,041 S \* 8/2000 Medema et al. .... D32/22  
D448,531 S \* 9/2001 Paterson et al. .... D32/31  
D451,253 S \* 11/2001 Paterson et al. .... D32/31

6,446,303 B1 \* 9/2002 Paterson et al. .... 15/350  
D480,521 S \* 10/2003 Medema ..... D32/31  
D493,925 S \* 8/2004 Paterson et al. .... D32/31  
D558,940 S \* 1/2008 Griffin ..... D32/22  
D566,913 S \* 4/2008 Griffin ..... D32/22

\* cited by examiner

*Primary Examiner*—Ruth McInroy

(74) *Attorney, Agent, or Firm*—Kathy Mojibi Kavcioglu

(57) **CLAIM**

I claim the ornamental design of a vacuum cleaner, as shown and described.

**DESCRIPTION**

FIG. 1 is a perspective view of a vacuum cleaner showing my new design;

FIG. 2 is a front view thereof;

FIG. 3 is a right side view thereof;

FIG. 4 is a left side view thereof;

FIG. 5 is a rear view thereof;

FIG. 6 is a top plan view thereof; and,

FIG. 7 is a bottom view thereof.

**1 Claim, 6 Drawing Sheets**

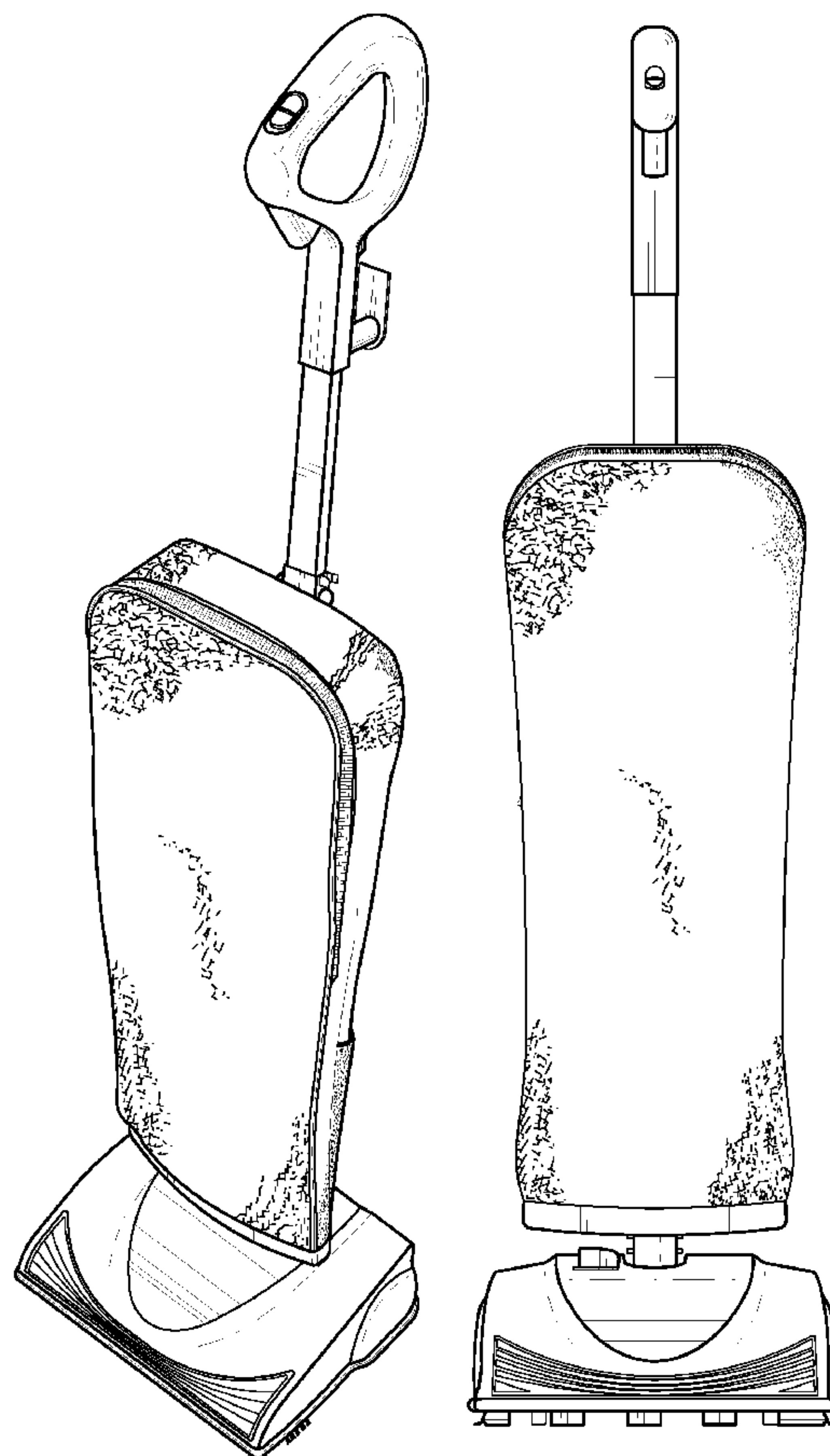

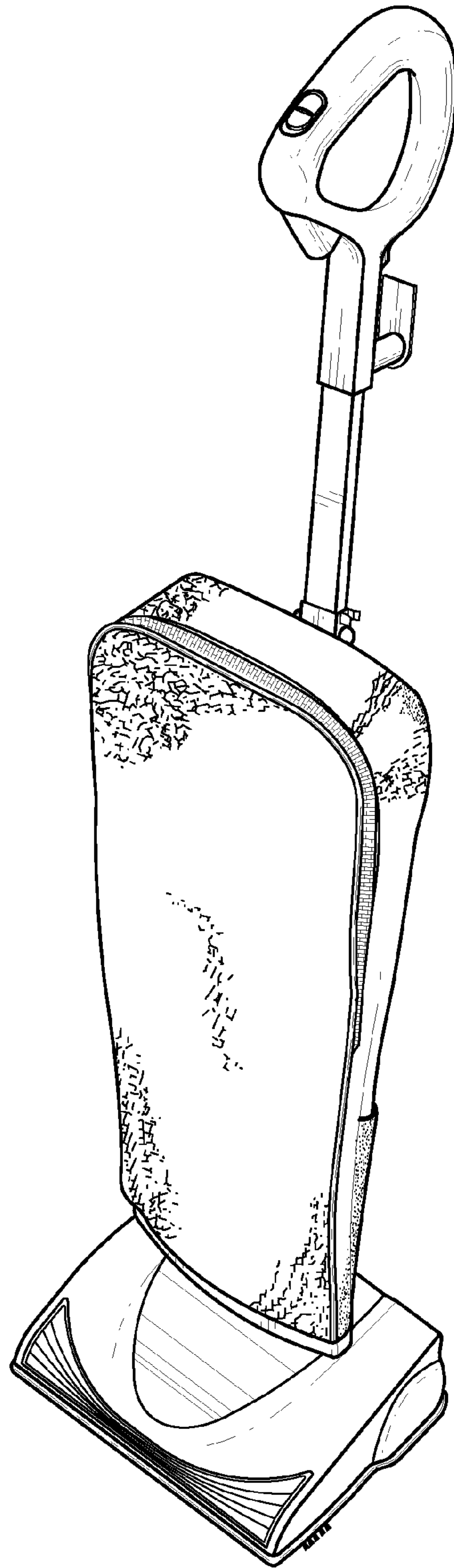

FIG. 1

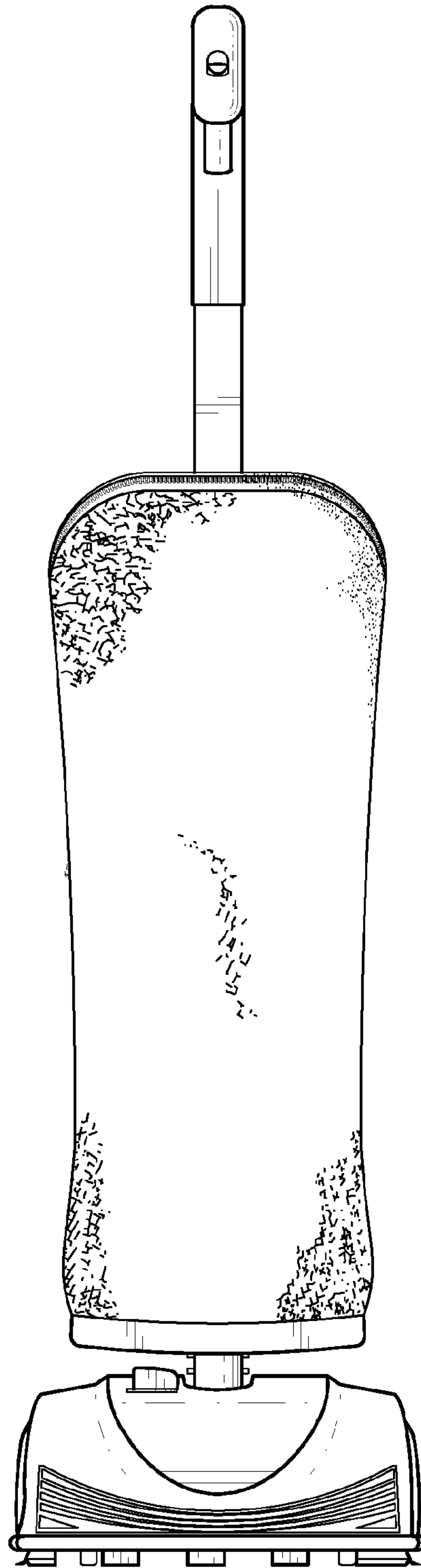

FIG. 2

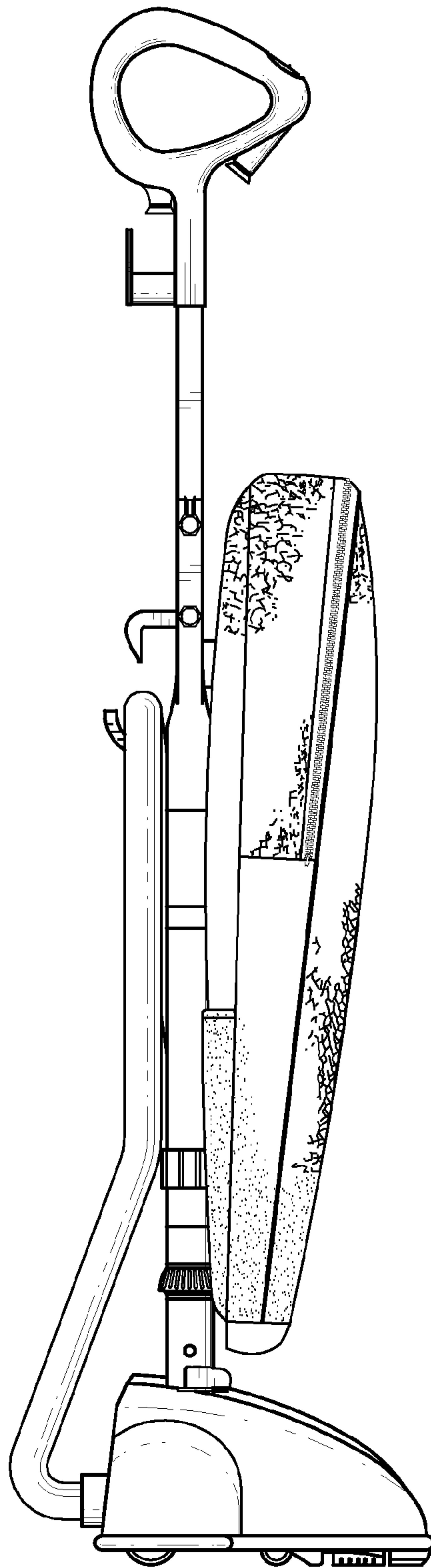

FIG. 3

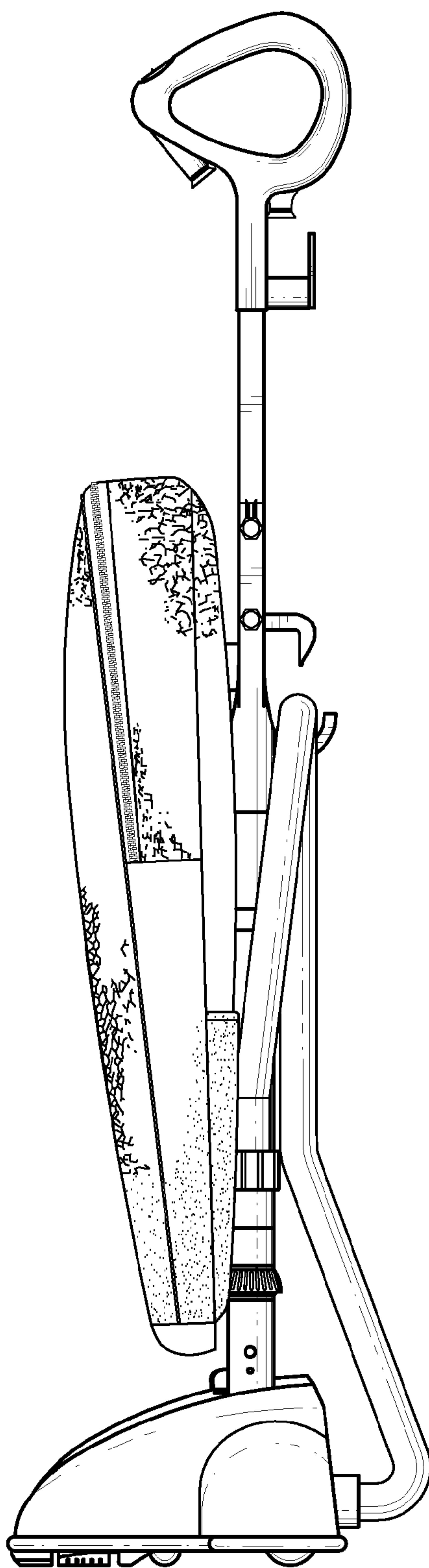

FIG. 4

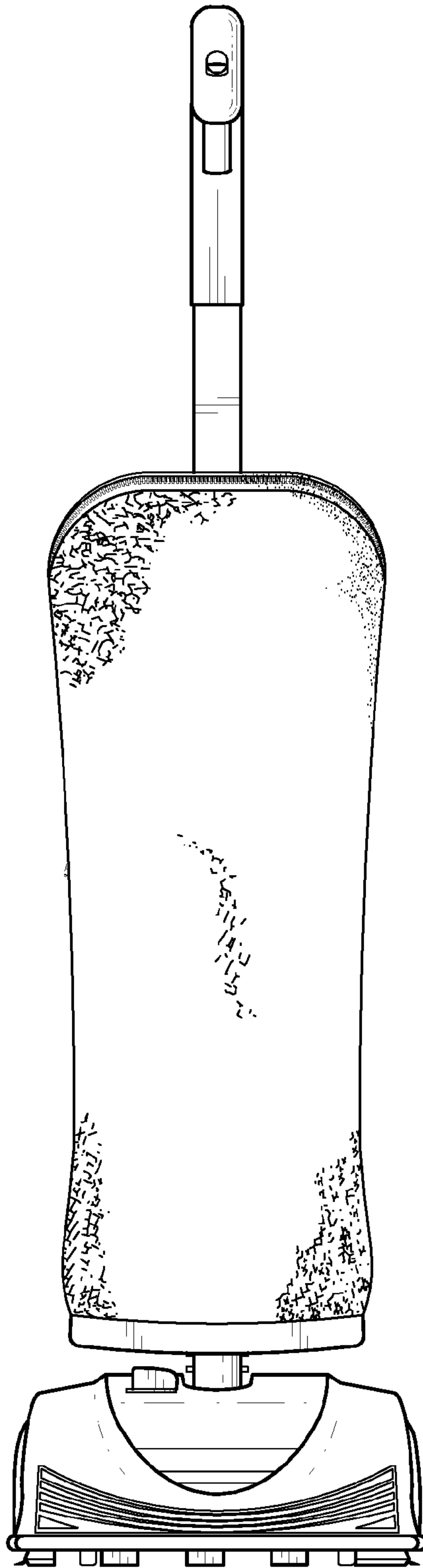

FIG. 5

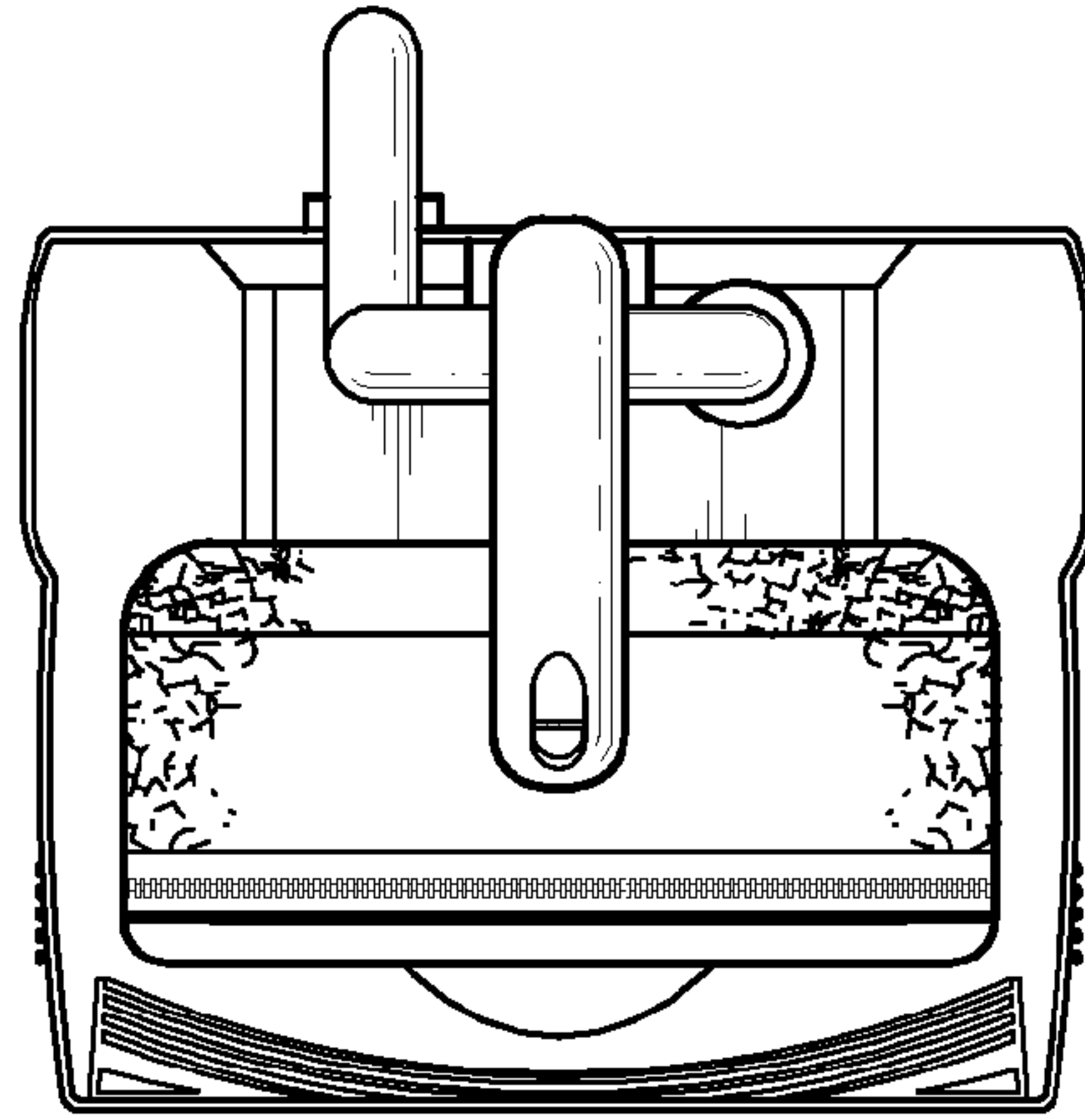

FIG. 6

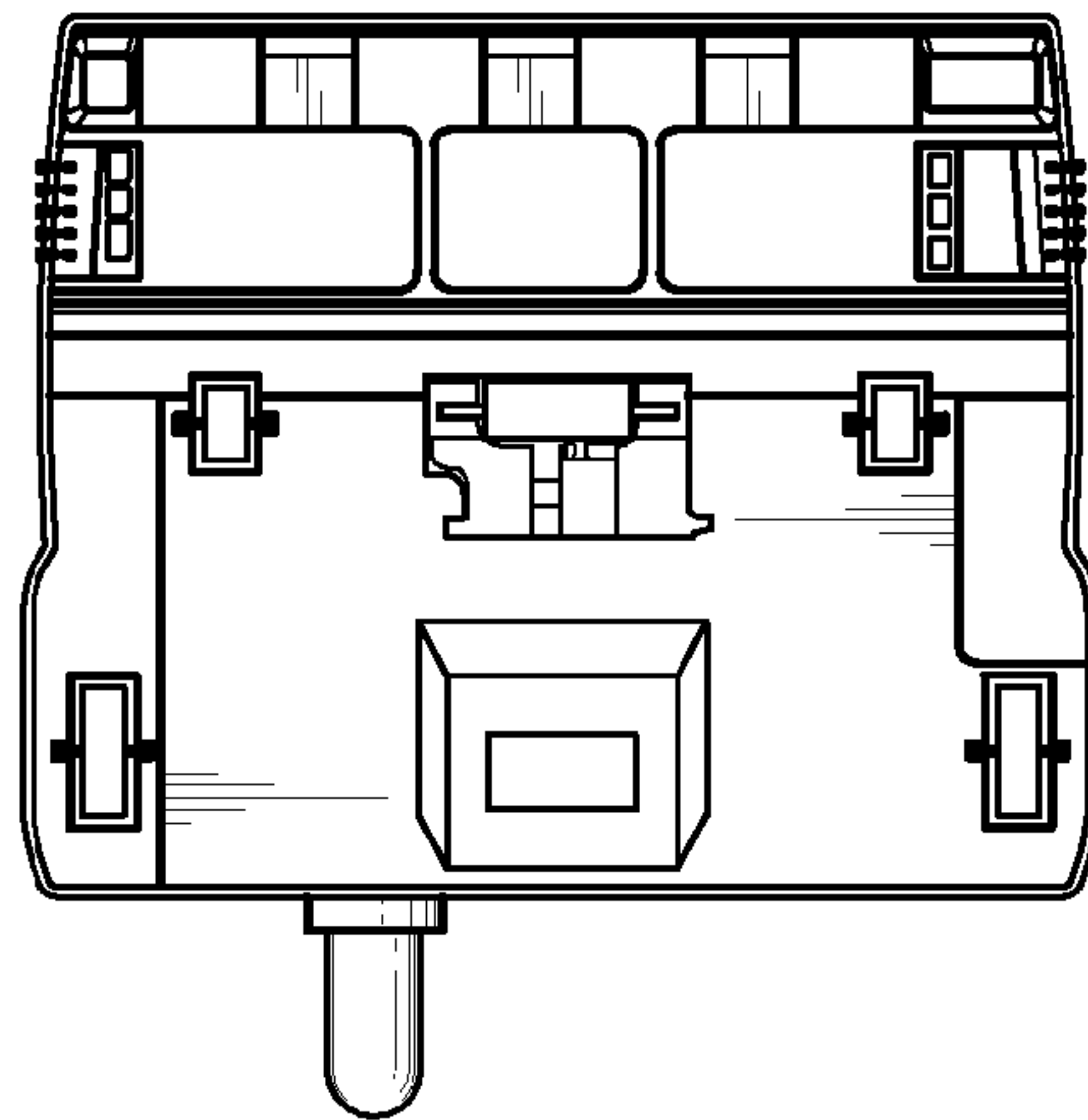

FIG. 7