



US00D588755S

(12) **United States Design Patent**  
**Farrell**

(10) **Patent No.:** **US D588,755 S**

(45) **Date of Patent:** **\*\* Mar. 17, 2009**

(54) **PET PLATFORM FOR A VEHICLE**

(76) **Inventor:** **Cyril Farrell**, 1 Anstey Place, Grand Falls, NF (CA) A2A 2S4

(\*\*) **Term:** **14 Years**

(21) **Appl. No.:** **29/296,052**

(22) **Filed:** **Oct. 12, 2007**

(51) **LOC (9) Cl.** ..... **30-02**

(52) **U.S. Cl.** ..... **D30/119; D30/118**

(58) **Field of Classification Search** ..... **D30/118;**  
**D6/601-604, 595-596; 5/417; 119/496-497,**  
**119/771, 28.5**

See application file for complete search history.

(56) **References Cited**

**U.S. PATENT DOCUMENTS**

3,797,462	A *	3/1974	Davis	.....	119/771
4,512,286	A *	4/1985	Rux	.....	119/771
D309,514	S *	7/1990	Marcus et al.	.....	D30/118
D320,522	S *	10/1991	Deremiah	.....	D6/601
5,123,377	A *	6/1992	Edwards	.....	119/28.5
5,479,892	A *	1/1996	Edwards	.....	119/771
5,487,361	A *	1/1996	Dean	.....	119/28.5
D376,447	S *	12/1996	Stump	.....	D30/118
D424,358	S *	5/2000	Wang	.....	D6/596
D461,966	S *	8/2002	Reece	.....	D30/118
6,588,365	B2 *	7/2003	Best Wright	.....	119/28.5
6,591,787	B1	7/2003	Gantz et al.	.....	
6,729,263	B2 *	5/2004	Miale et al.	.....	119/28.5
D522,181	S *	5/2006	Lauzon	.....	D30/118
2004/0025795	A1 *	2/2004	Miale et al.	.....	119/28.5
2006/0150922	A1 *	7/2006	Kroculick	.....	119/771
2007/0157891	A1 *	7/2007	Wayn	.....	119/771
2007/0226904	A1 *	10/2007	Huffman	.....	5/417

\* cited by examiner

*Primary Examiner*—Cathy Anne MacCormac

(74) *Attorney, Agent, or Firm*—Wilmer Cutler Pickering Hale & Dorr LLP

(57) **CLAIM**

The ornamental design for a pet platform for a vehicle, as shown and described.

**DESCRIPTION**

FIG. 1 is a top perspective view of a pet platform for a vehicle showing my new design;

FIG. 2 is a top view thereof;

FIG. 3 is a bottom view thereof;

FIG. 4 is a back view thereof;

FIG. 5 is a front view thereof;

FIG. 6 is a left view thereof;

FIG. 7 is a right view thereof;

FIG. 8 is a top perspective view of a padded pet platform for a vehicle showing my new design;

FIG. 9 is a top view thereof;

FIG. 10 is a bottom view thereof;

FIG. 11 is a back view thereof;

FIG. 12 is a front view thereof;

FIG. 13 is a left view thereof;

FIG. 14 is a right view thereof; and,

FIG. 15 is a bottom perspective view thereof.

The broken lines of FIGS. 1-15 are for purposes of illustration only and form no part of the claimed design.

**1 Claim, 11 Drawing Sheets**

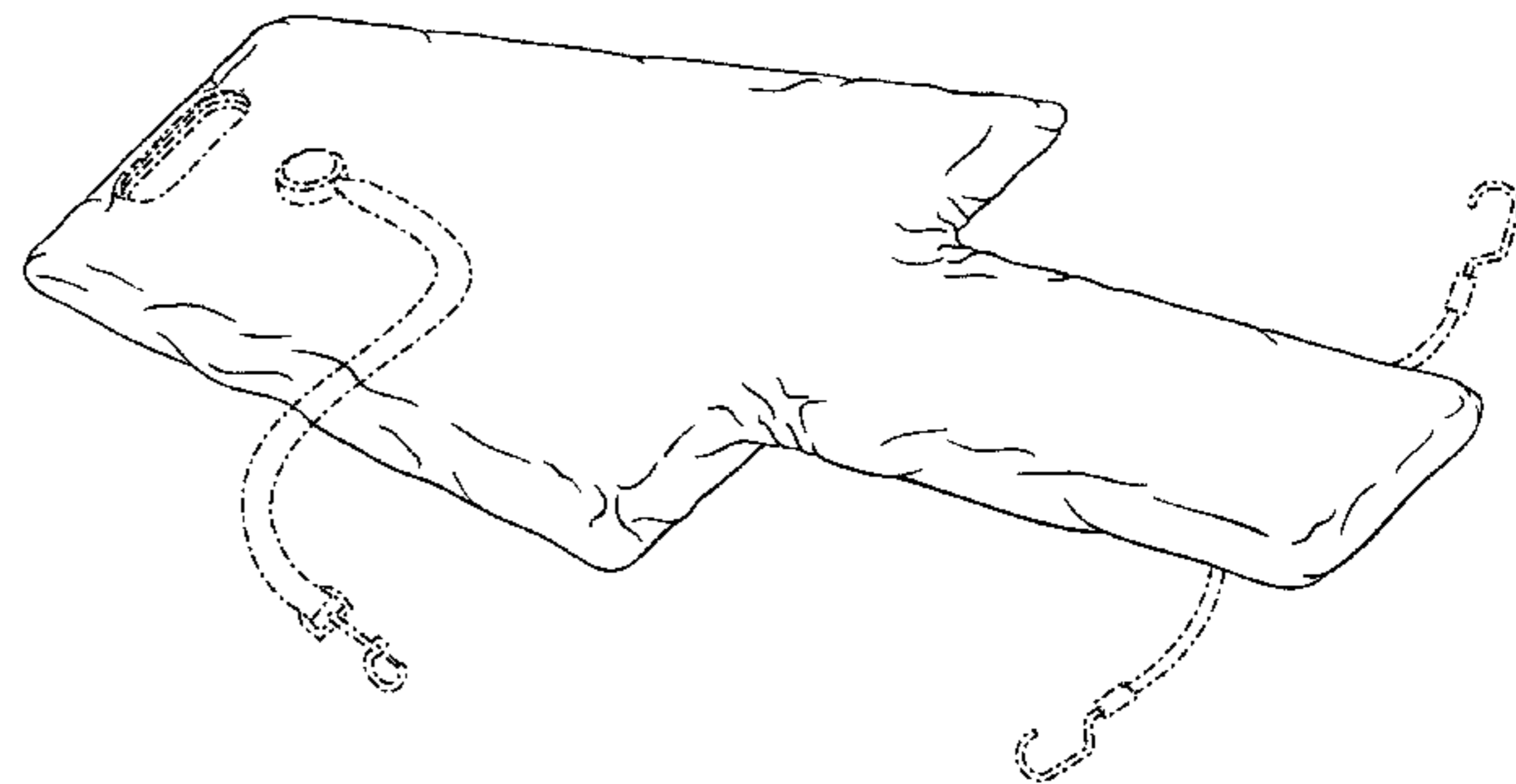
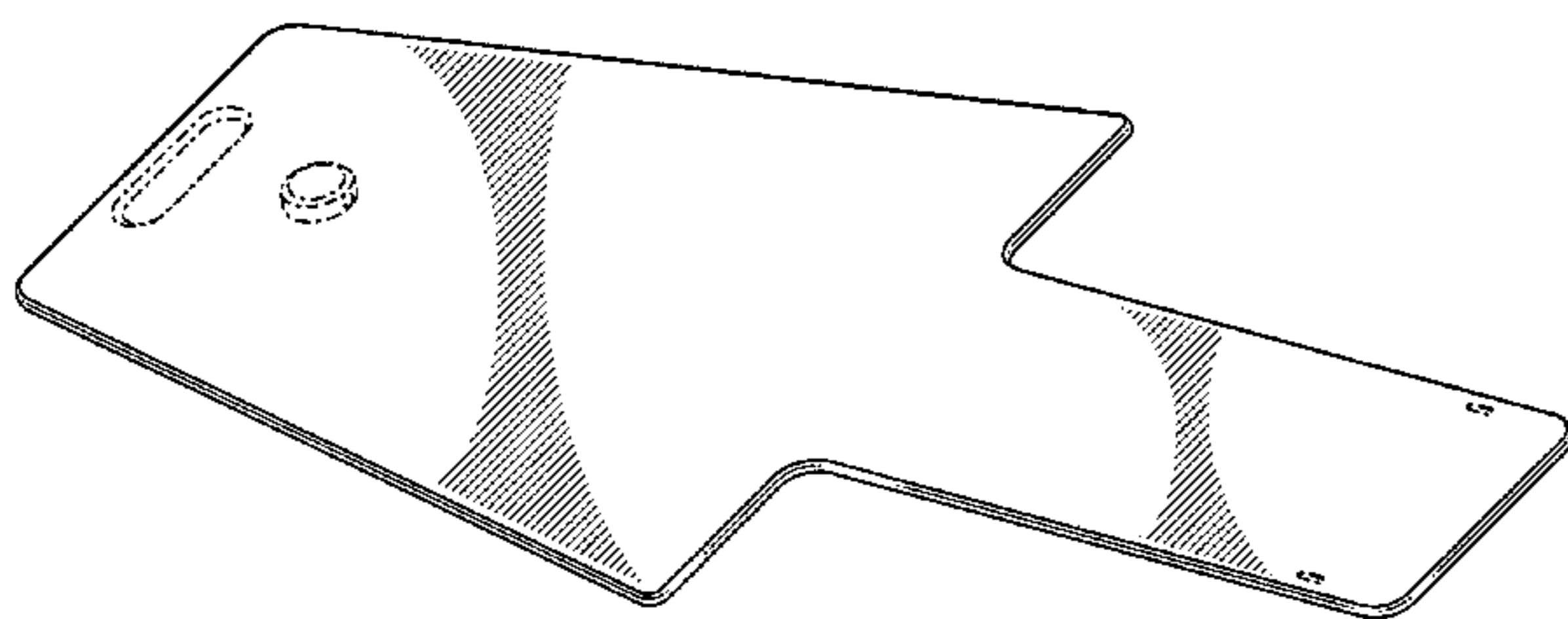

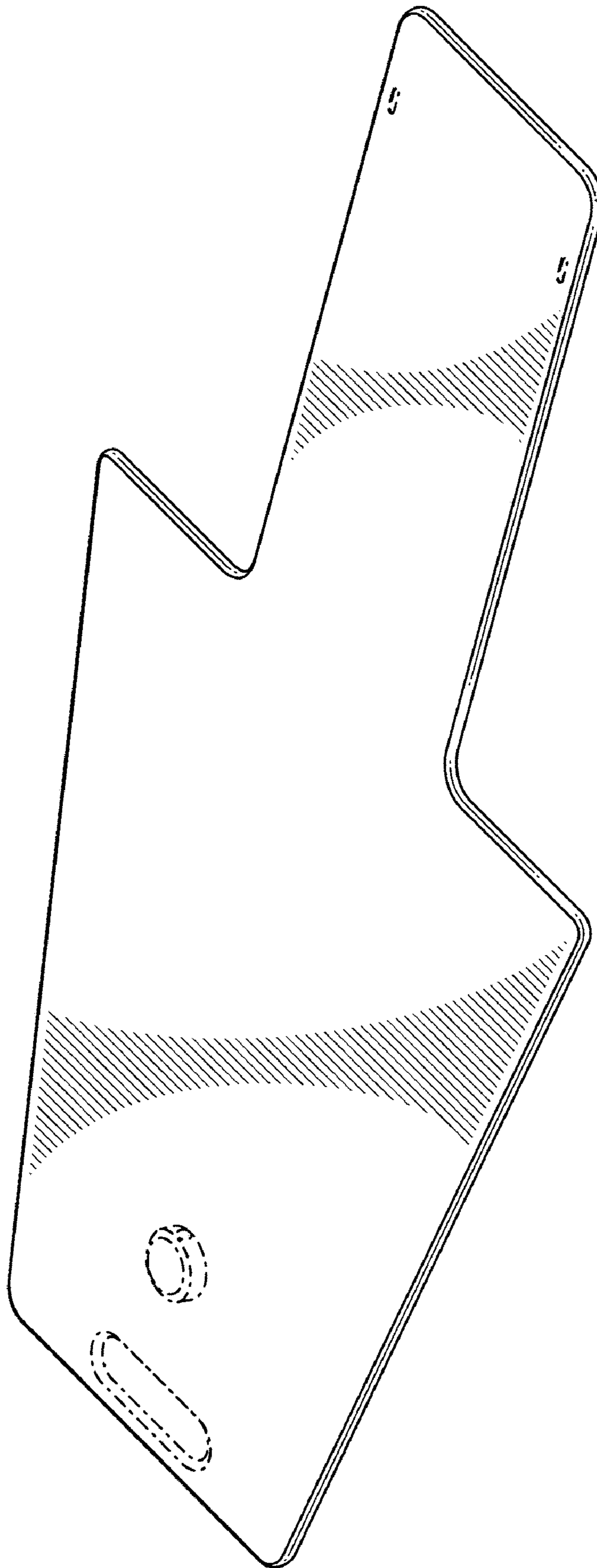

FIG. 1

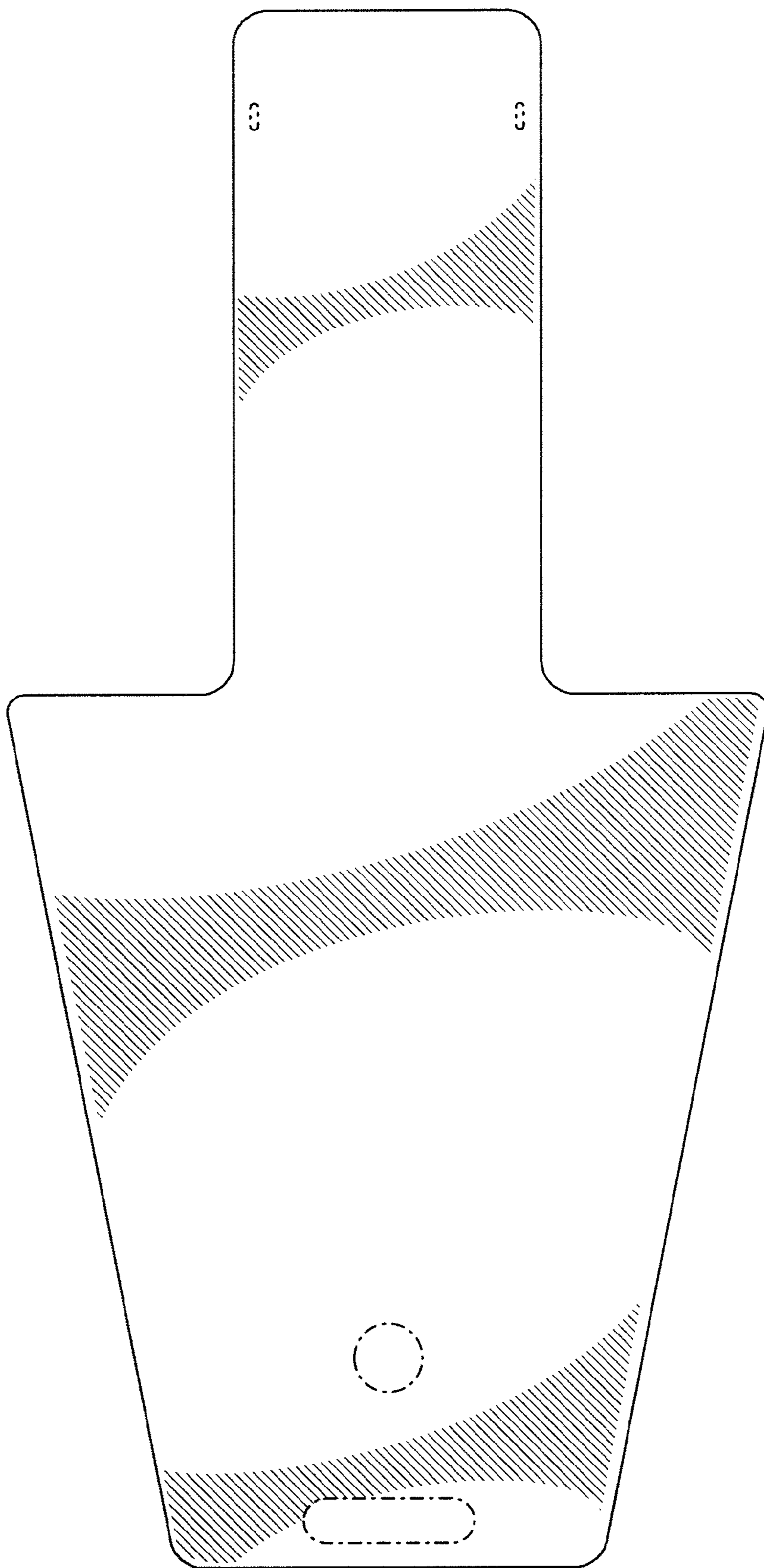

FIG. 2

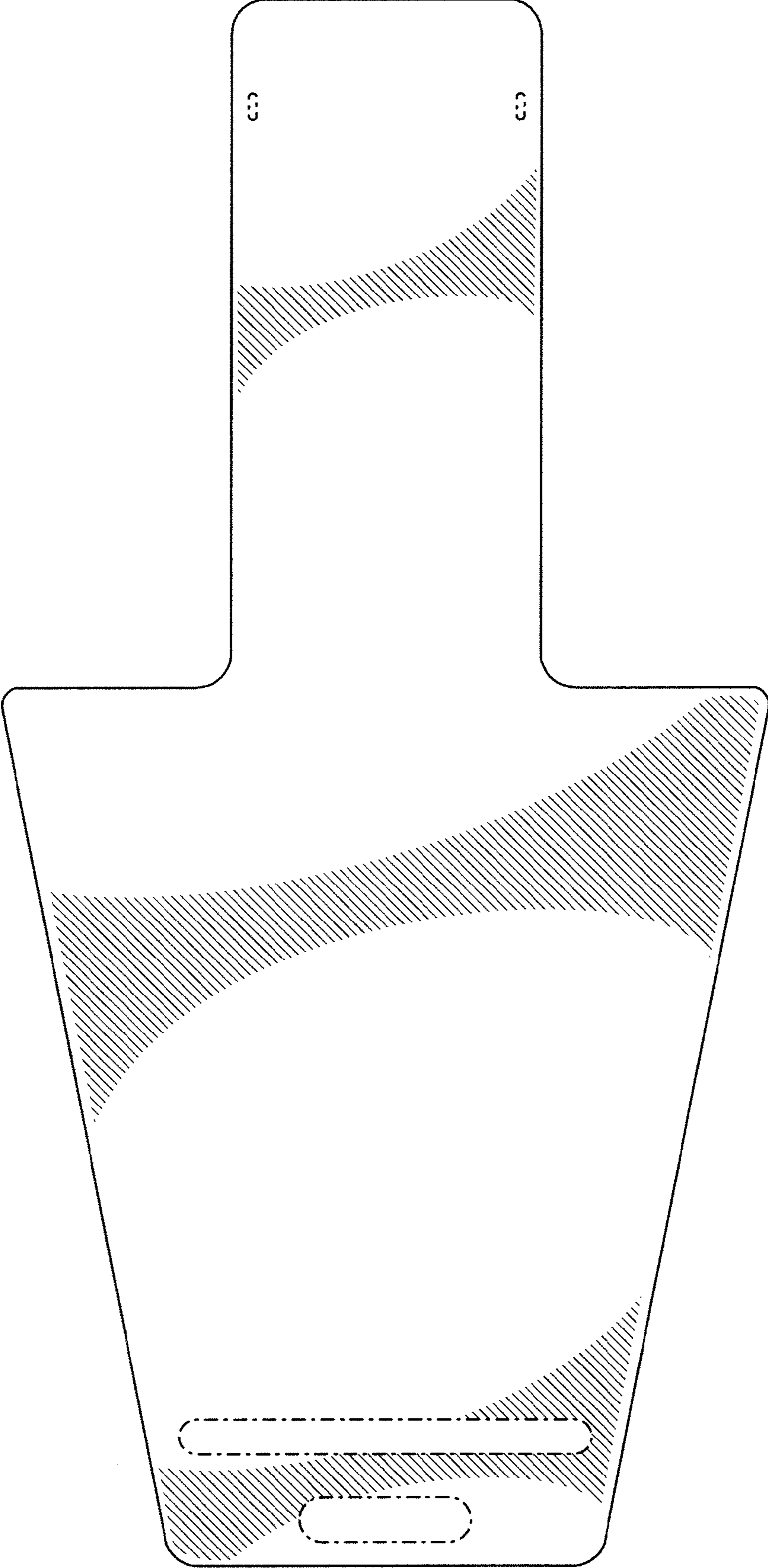

FIG. 3



FIG. 4



FIG. 5

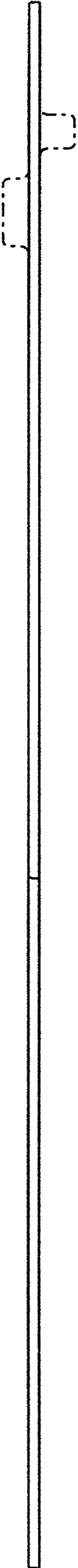

FIG. 6

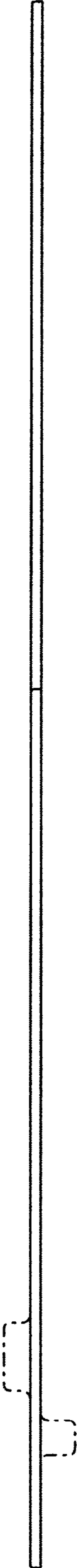

FIG. 7



FIG. 8

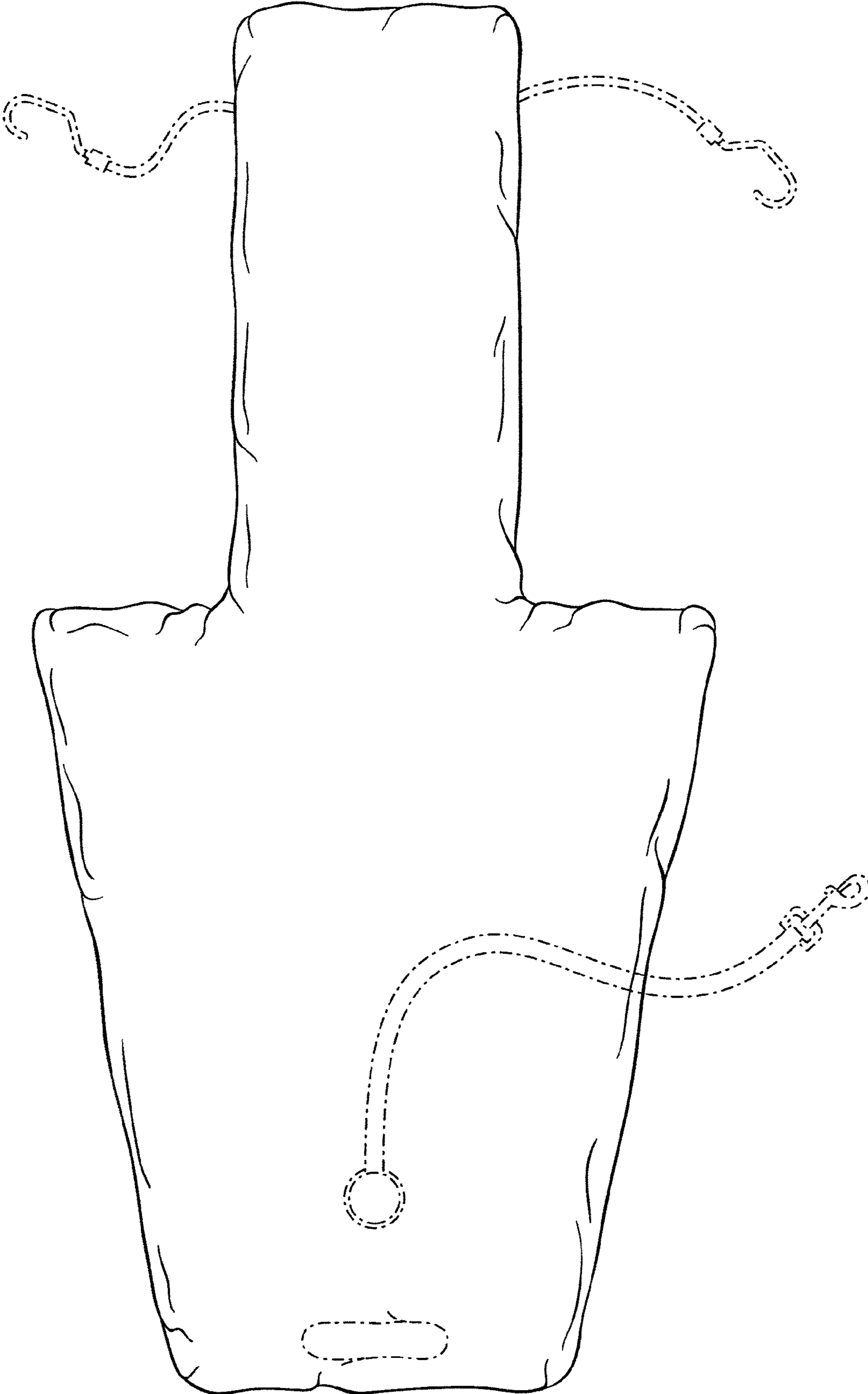

FIG. 9



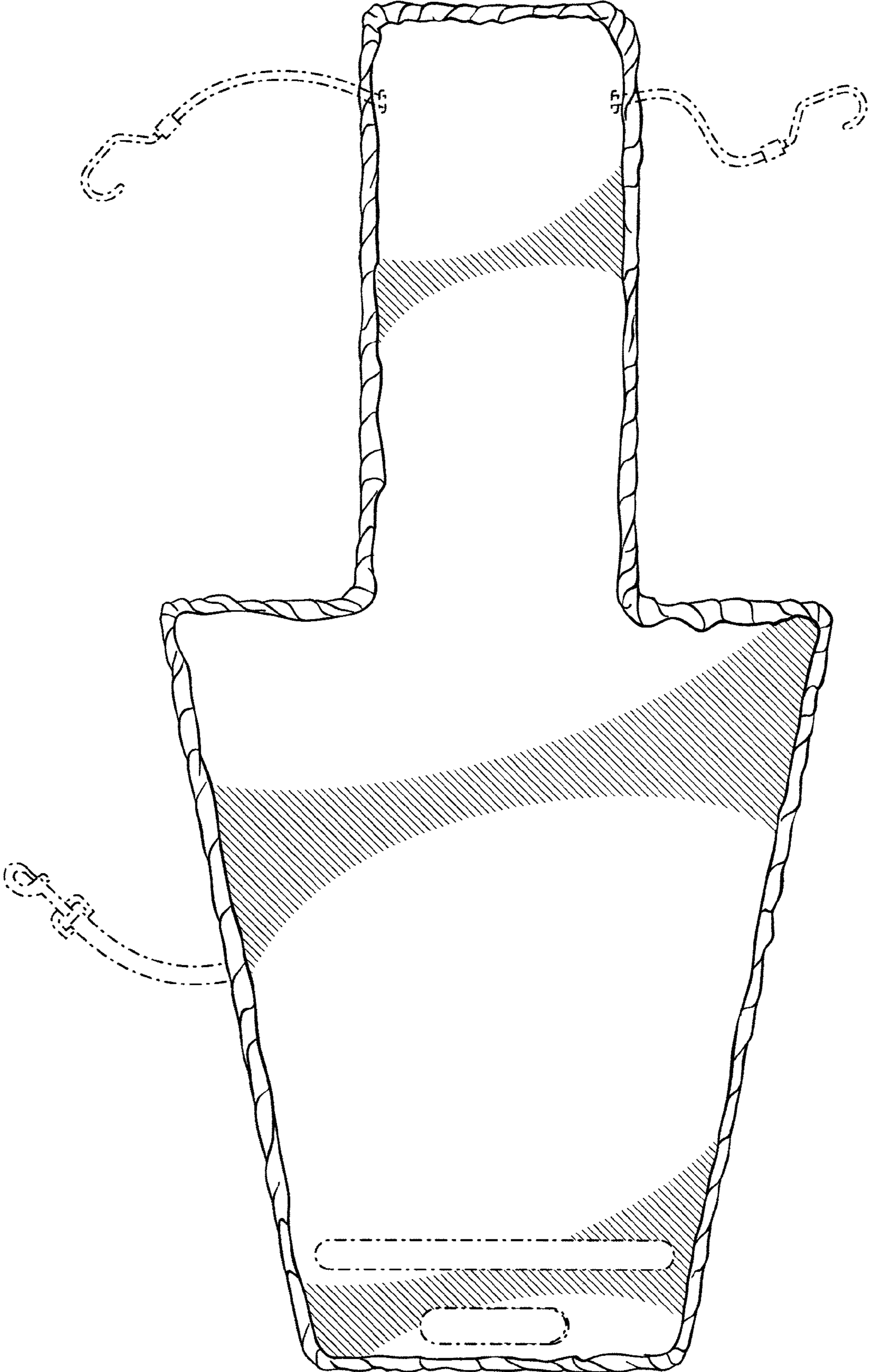

FIG. 10

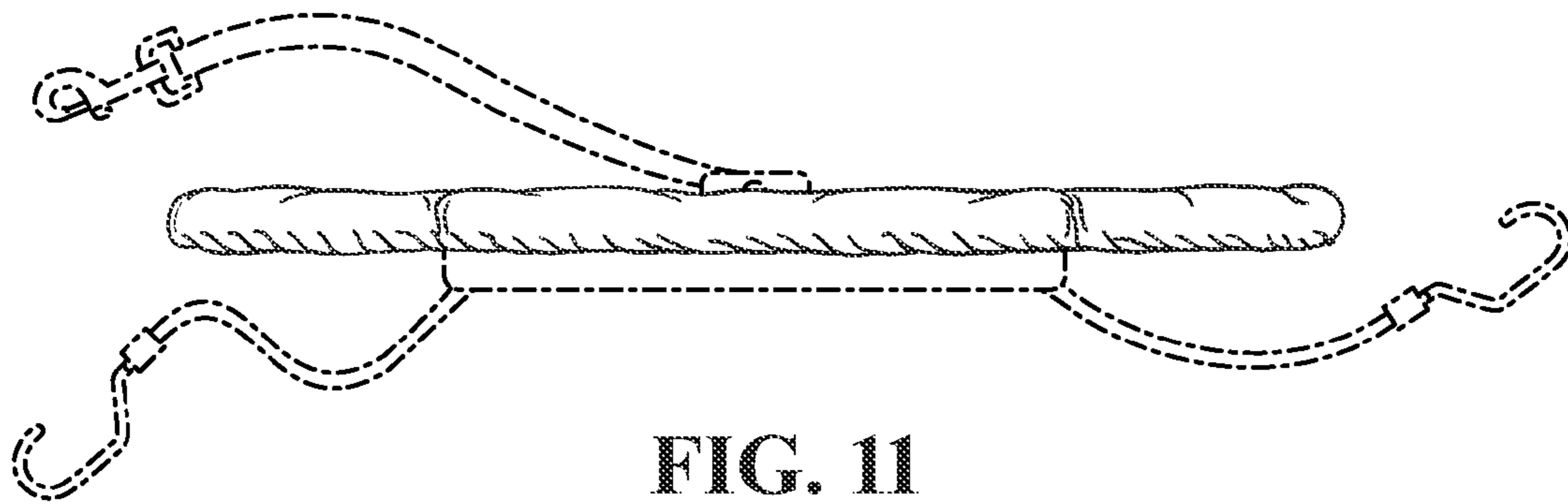

FIG. 11

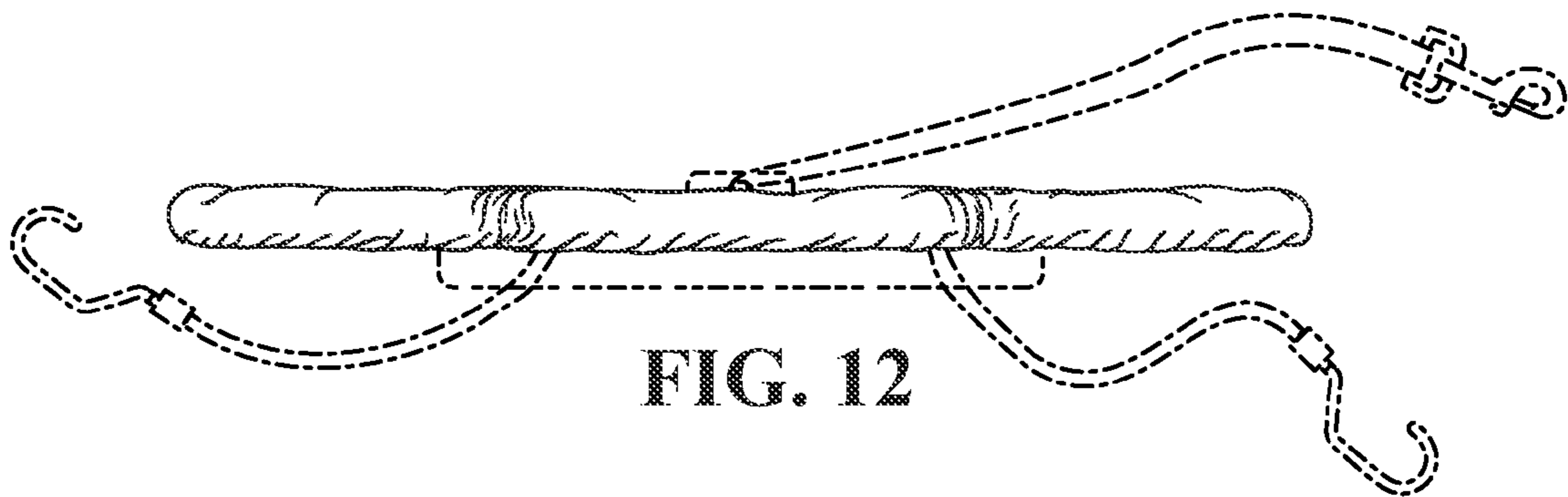

FIG. 12

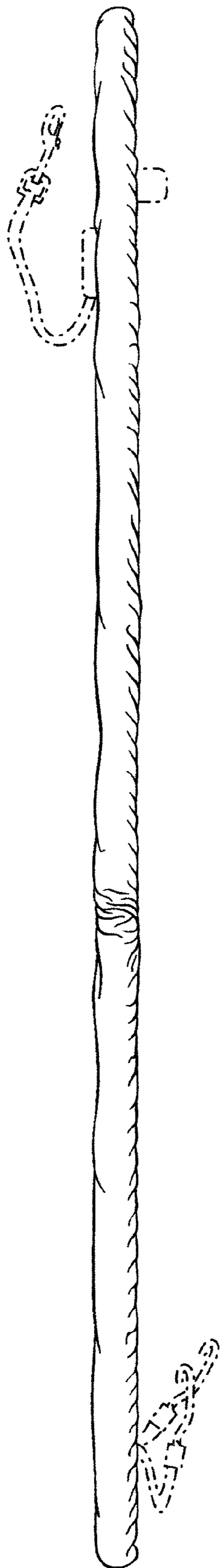

FIG. 13

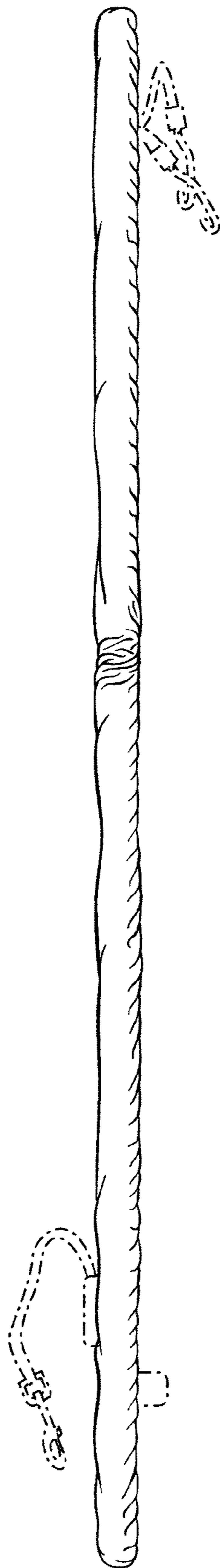

FIG. 14

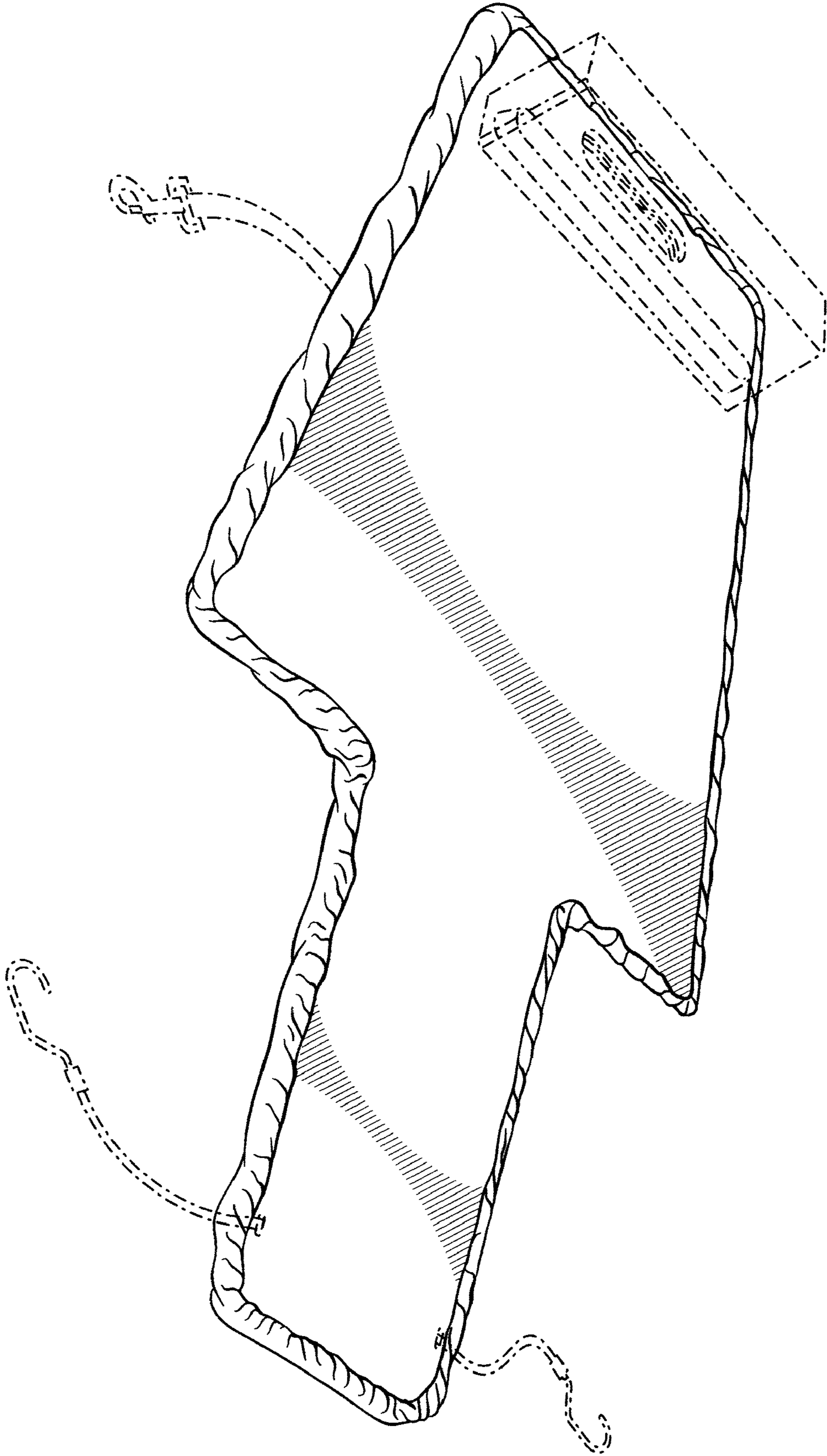

FIG. 15