



US00D588735S

(12) **United States Design Patent**
Woodard

(10) **Patent No.:** **US D588,735 S**
(45) **Date of Patent:** **** Mar. 17, 2009**

(54) **RECONFIGURABLE PORTABLE LIGHT**

(57) **CLAIM**

(75) Inventor: **M. Rufus Woodard**, Boston, MA (US)

I claim the ornamental design for a reconfigurable portable light, as shown and described.

(73) Assignee: **Brookstone Purchasing, Inc.**,
Merrimack, NH (US)

DESCRIPTION

(**) Term: **14 Years**

FIG. 1 is a top perspective view of a reconfigurable portable light showing my new design, including and elongated stem and a head portion with a cover shown in an open position, wherein said light is in a first coiled configuration.

(21) Appl. No.: **29/292,889**

FIG. 2 is a top perspective view thereof, with said cover in a closed position.

(22) Filed: **Oct. 31, 2007**

FIG. 3 is a top perspective view thereof, with said cover in a half-open position.

(51) **LOC (9) Cl.** **26-05**

(52) **U.S. Cl.** **D26/61**

(58) **Field of Classification Search** D26/14,
D26/60-66, 93; 362/410, 413, 414, 419,
362/427, 285, 287, 282, 277, 275, 274, 271,
362/270, 269, 431

FIG. 4 is a front plan view of said light in a second elongated configuration, with said cover in a closed position.

See application file for complete search history.

FIG. 5 is a side plan view of said light in a third, heightened configuration, with said cover in said open position.

(56) **References Cited**

U.S. PATENT DOCUMENTS

3,689,763	A *	9/1972	Hamburger et al.	174/113 R
4,760,499	A *	7/1988	Il	362/512
D399,021	S *	9/1998	Lam	D26/106
D409,322	S *	5/1999	Yang	D26/63
D460,204	S *	7/2002	Giese	D26/26
D484,272	S *	12/2003	Lay et al.	D26/113
D515,722	S *	2/2006	Opolka	D26/62

FIG. 6 is a side plan view thereof, with said cover in said half-open position.

* cited by examiner

FIG. 7 is an enlarged front plan view of said head portion, shown removed from said elongated stem for ease of illustration, with the cover in said closed position; and,

Primary Examiner—Cathron C Brooks

Assistant Examiner—Barbara Fox

(74) *Attorney, Agent, or Firm*—Grossman, Tucker, Perreault,
& Pflieger

FIG. 8 is an enlarged front plan view thereof, with the cover in an open position.

The bulb area of the reconfigurable portable light shown in broken lines in FIGS. 1, 3 and 8 forms no part of the claimed design.

The reconfigurable portable light is shown broken away in FIG. 4 for ease of illustration.

1 Claim, 8 Drawing Sheets

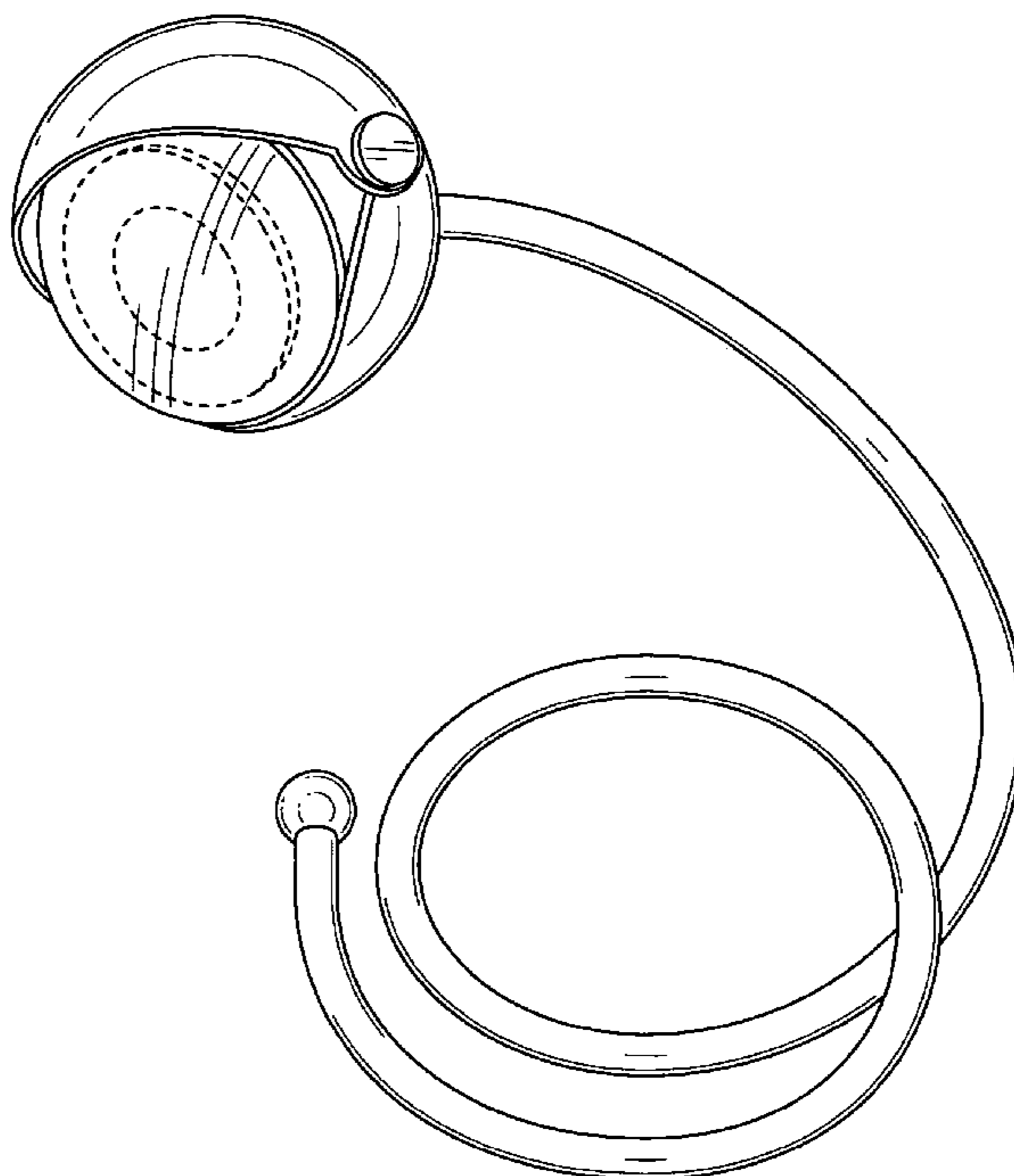

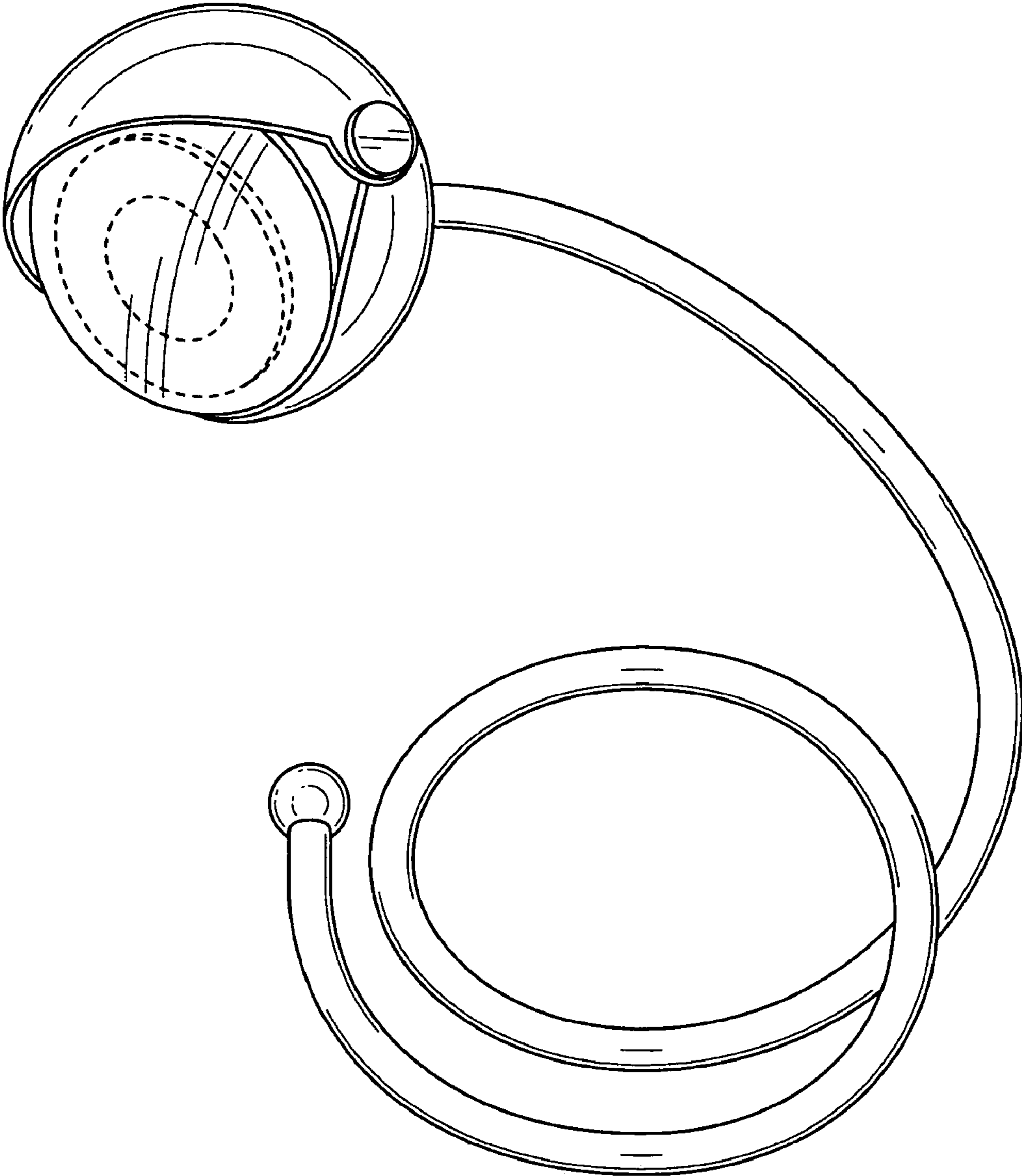

FIG. 1

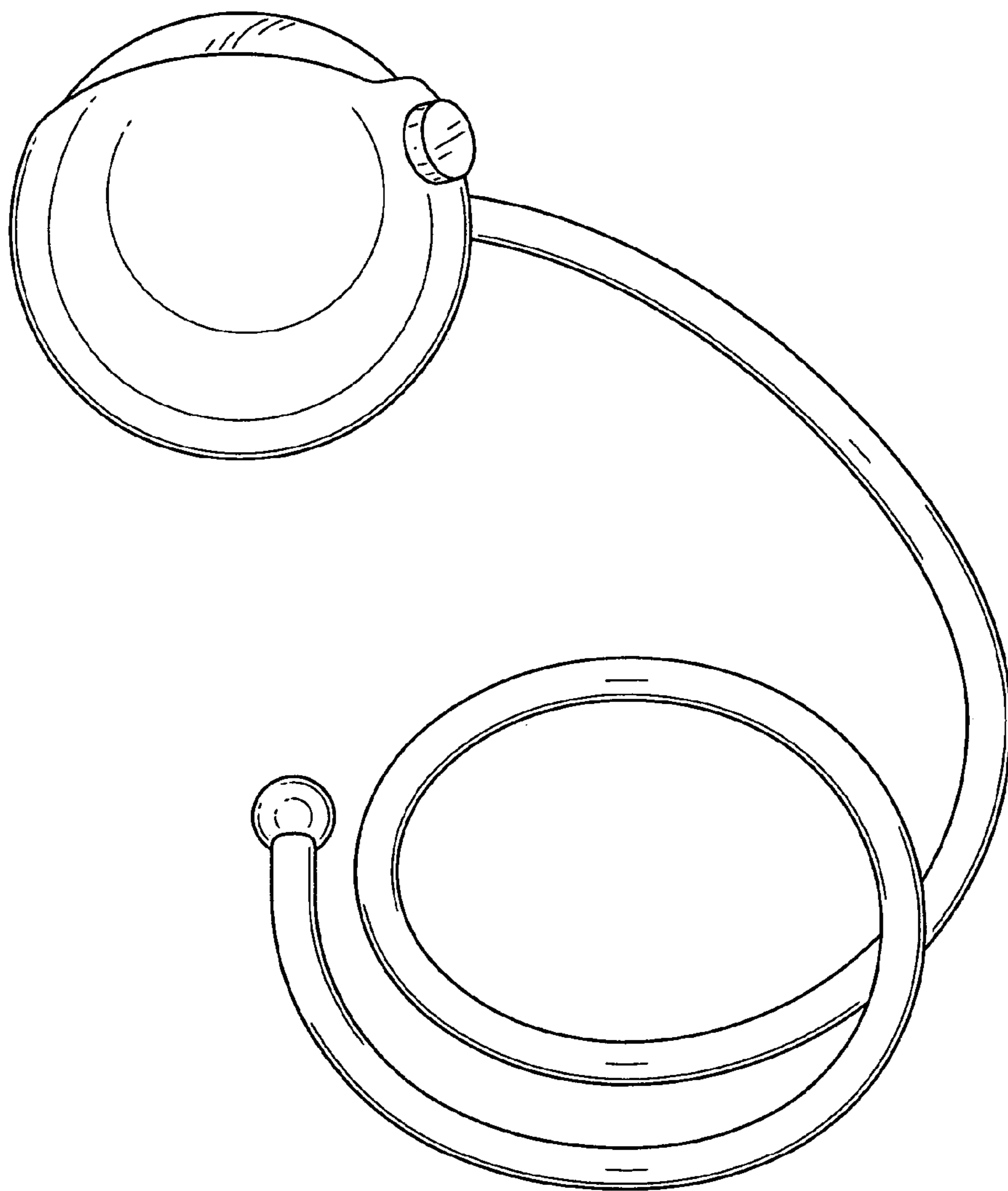

FIG. 2

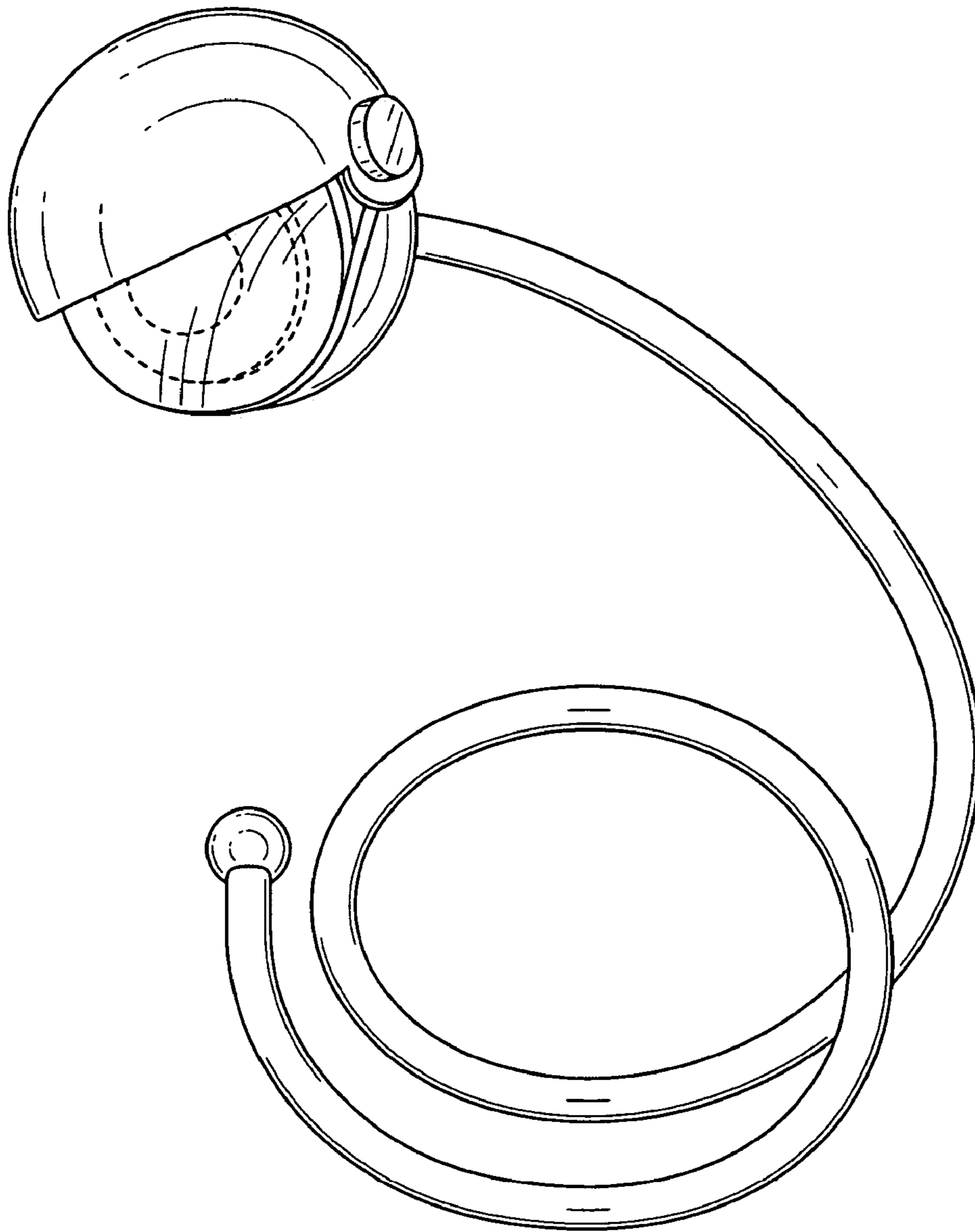

FIG. 3

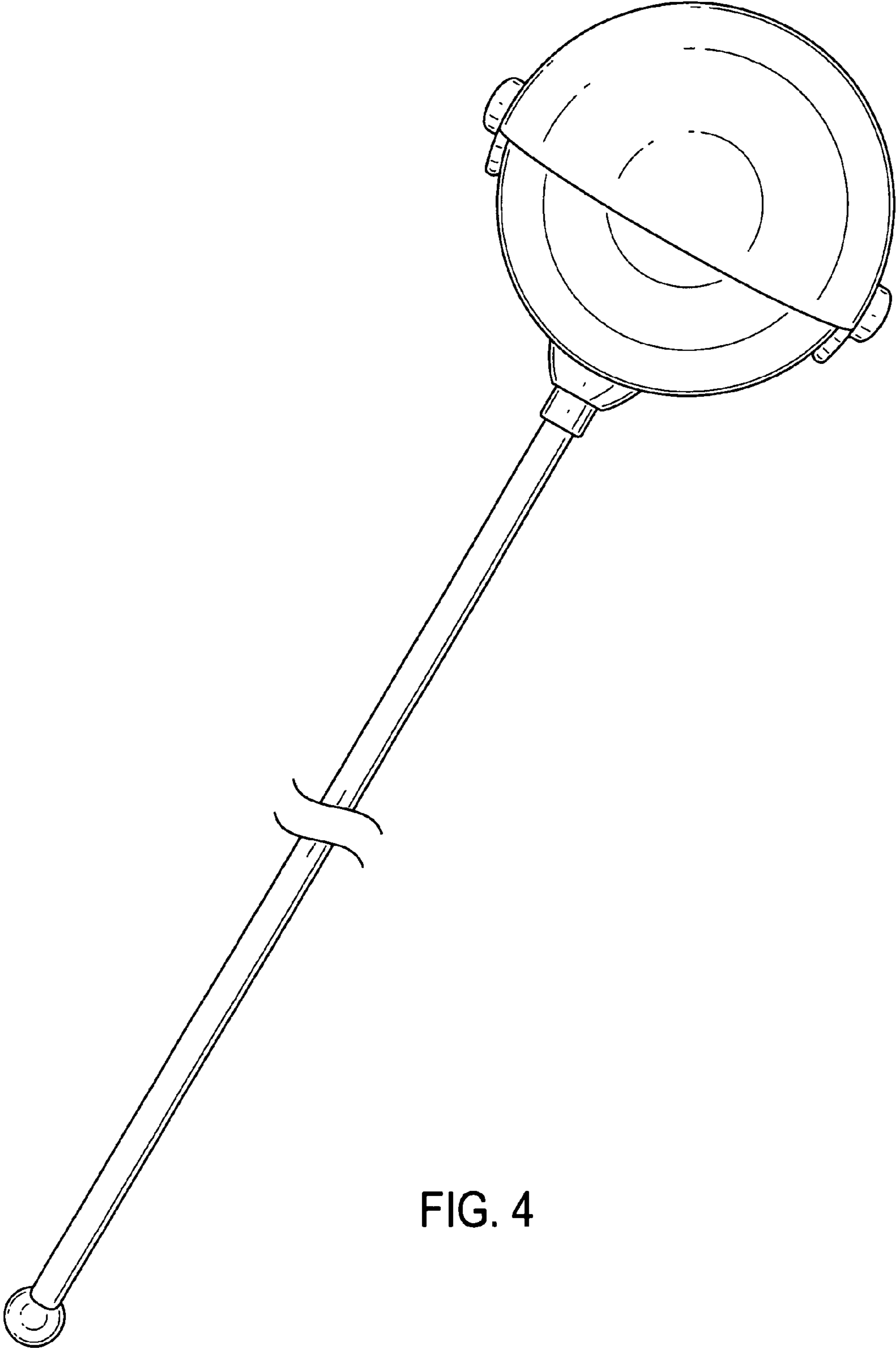

FIG. 4

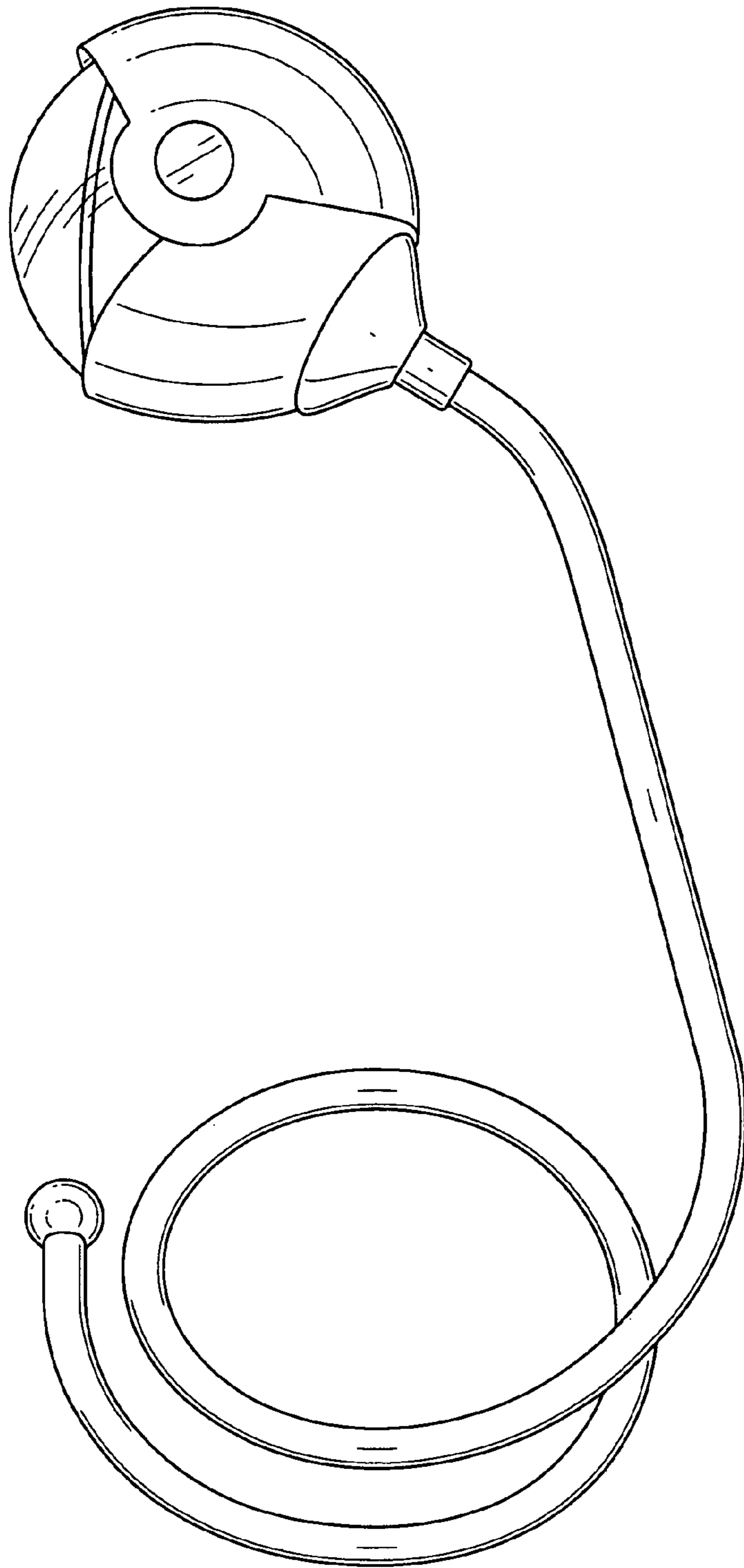

FIG. 5

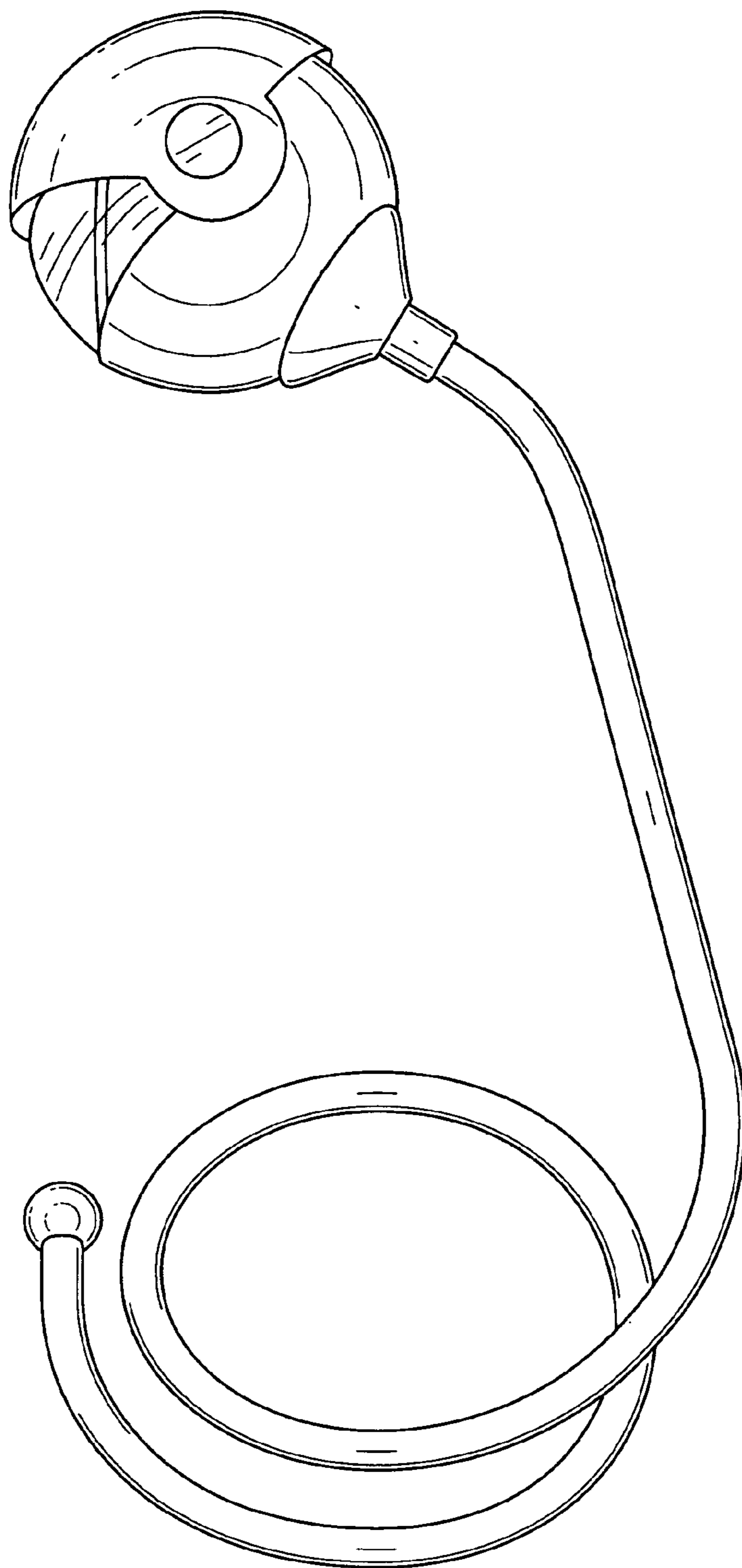

FIG. 6

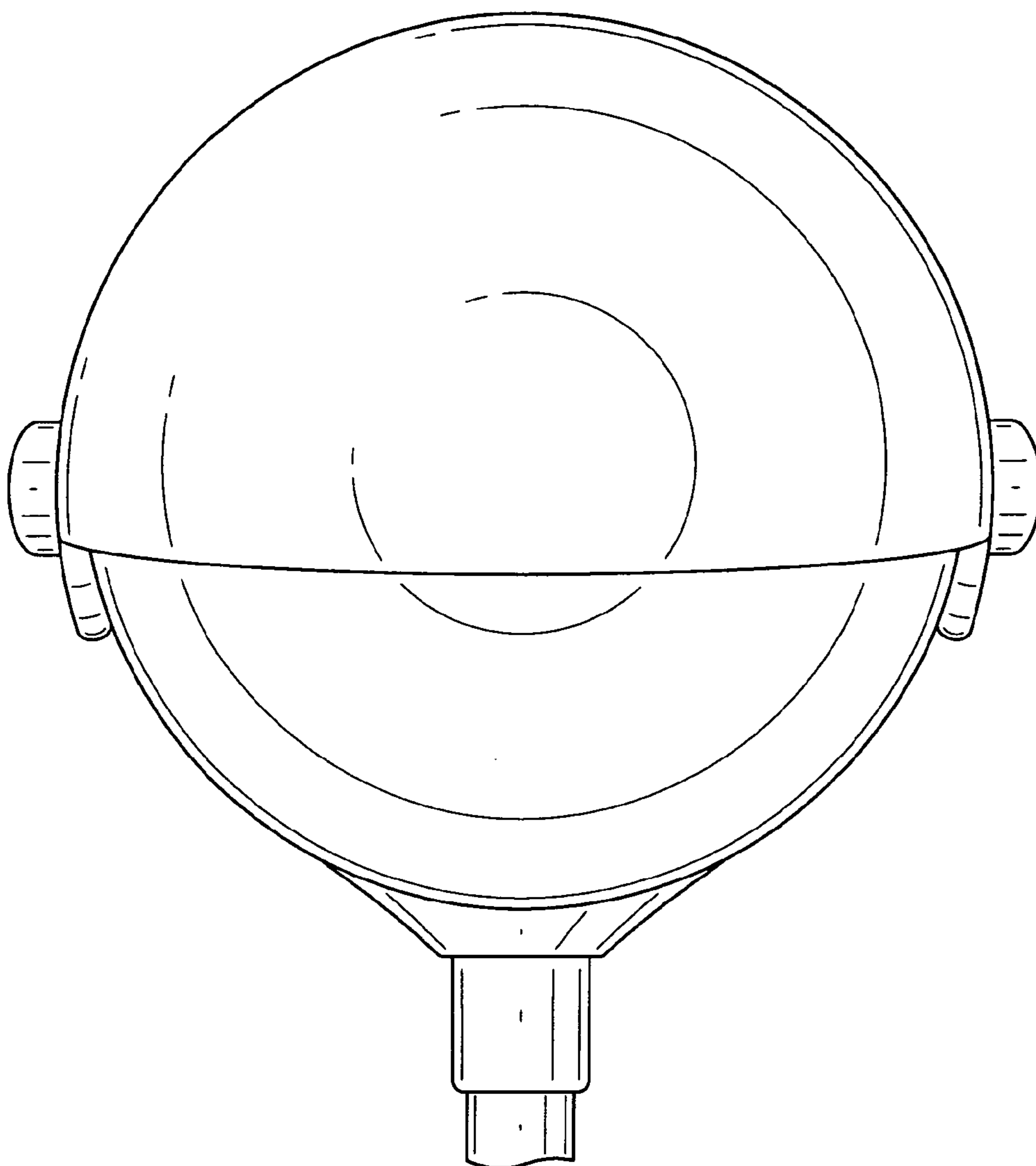

FIG. 7

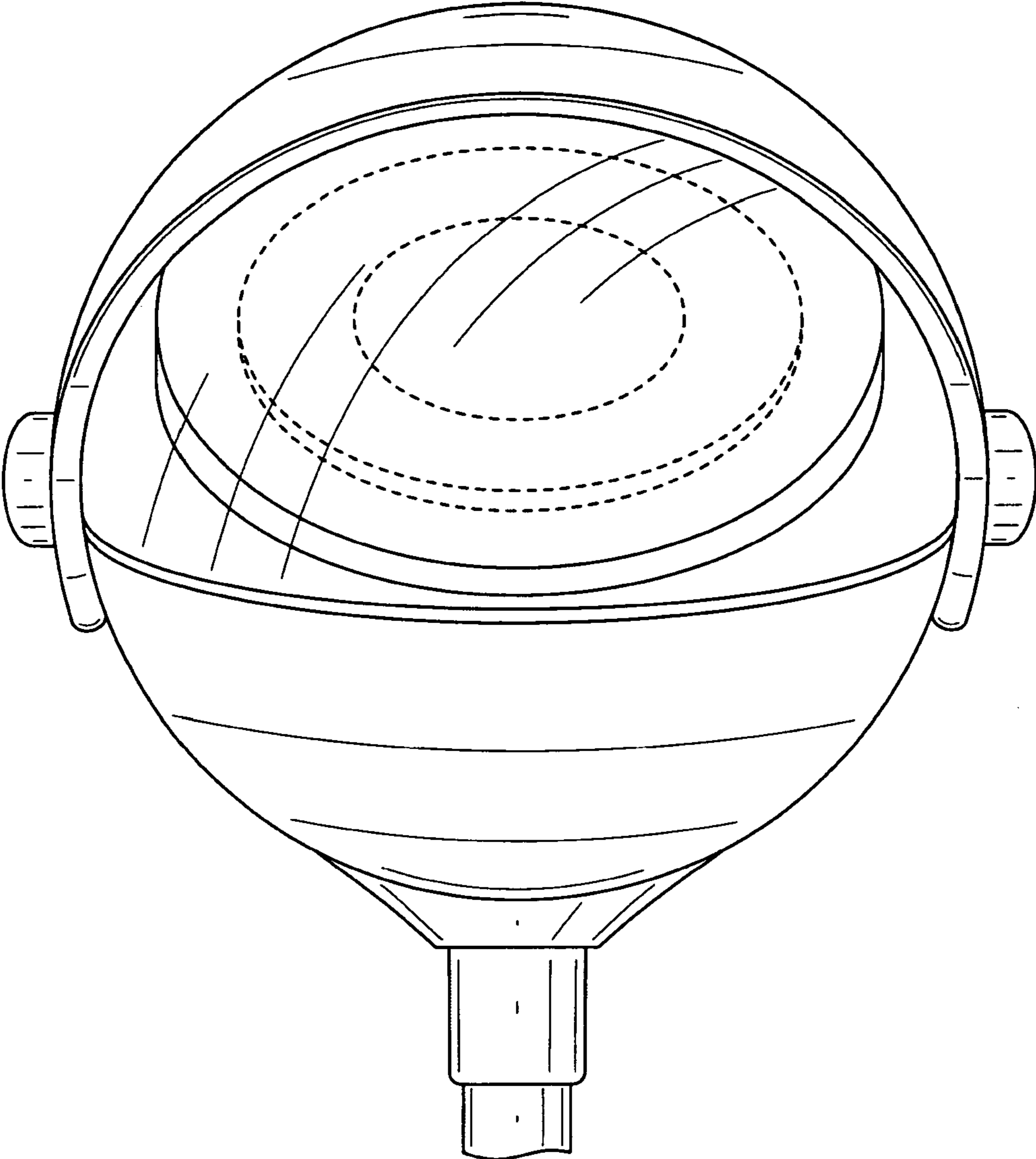

FIG. 8