



US00D588722S

(12) **United States Design Patent**
Cheng

(10) **Patent No.:** **US D588,722 S**

(45) **Date of Patent:** **** Mar. 17, 2009**

(54) **BICYCLE HEAD LIGHT**

(75) Inventor: **Loewi Siu Kwong Cheng**, New Territories (CN)

(73) Assignee: **Weston Pointer Ltd.**, Yuen Long, New Territories, Hong Kong (CN)

(**) Term: **14 Years**

(21) Appl. No.: **29/308,833**

(22) Filed: **Jul. 10, 2008**

(51) **LOC (9) Cl.** **26-06**

(52) **U.S. Cl.** **D26/28**

(58) **Field of Classification Search** D26/28-36;
362/459-468, 475-478, 485-487
See application file for complete search history.

(56) **References Cited**

U.S. PATENT DOCUMENTS

D540,481 S * 4/2007 Okuda D26/28
D540,966 S * 4/2007 Ueda et al. D26/28

D541,447 S * 4/2007 Ueda et al. D26/28
D560,833 S * 1/2008 Ueda et al. D26/28
D560,834 S * 1/2008 Nagano D26/28

* cited by examiner

Primary Examiner—Marcus A. Jackson

(74) *Attorney, Agent, or Firm*—Alix, Yale & Ristas, LLP

(57) **CLAIM**

The ornamental design for a bicycle head light, as shown and described.

DESCRIPTION

FIG. 1 is a front view of a bicycle head light showing my new design;

FIG. 2 is a rear view thereof;

FIG. 3 is a left side view thereof;

FIG. 4 is a right side view thereof;

FIG. 5 is a top plan view thereof; and,

FIG. 6 is a bottom plan front view thereof.

1 Claim, 6 Drawing Sheets

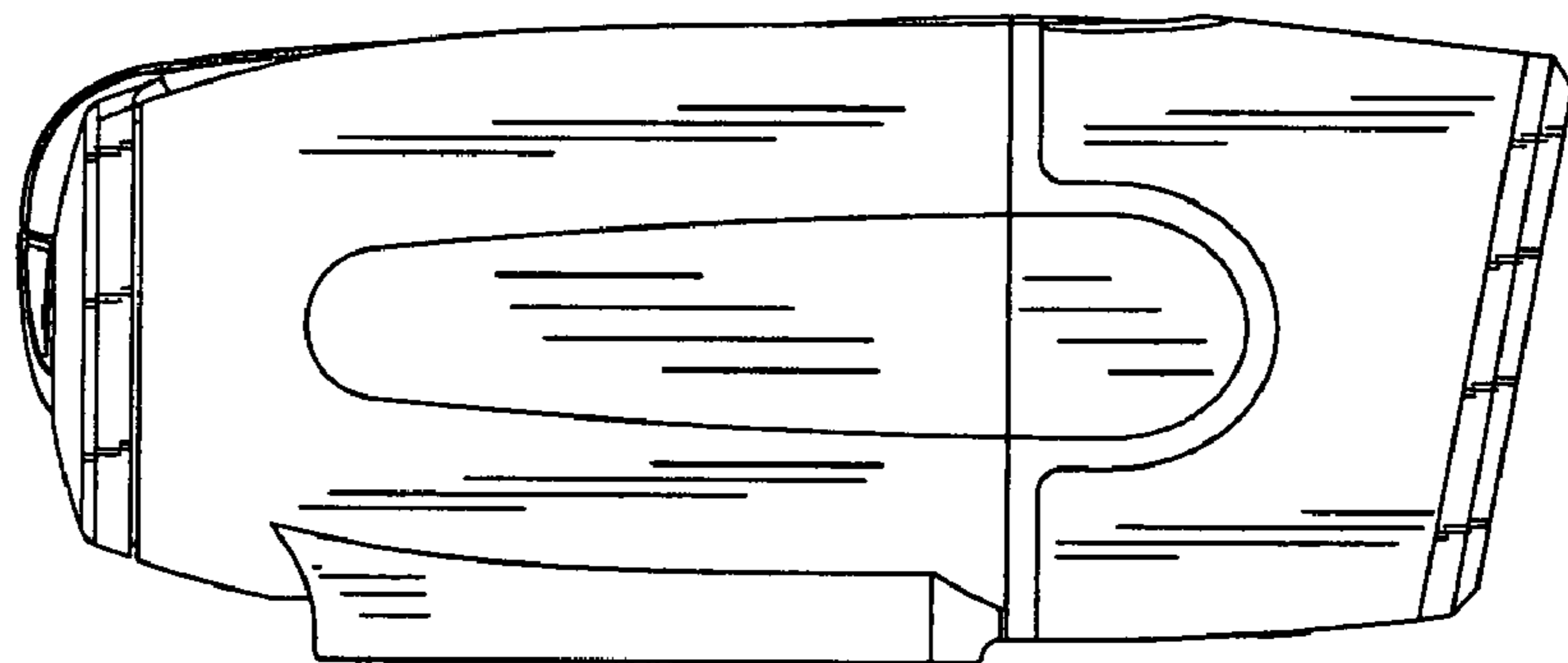
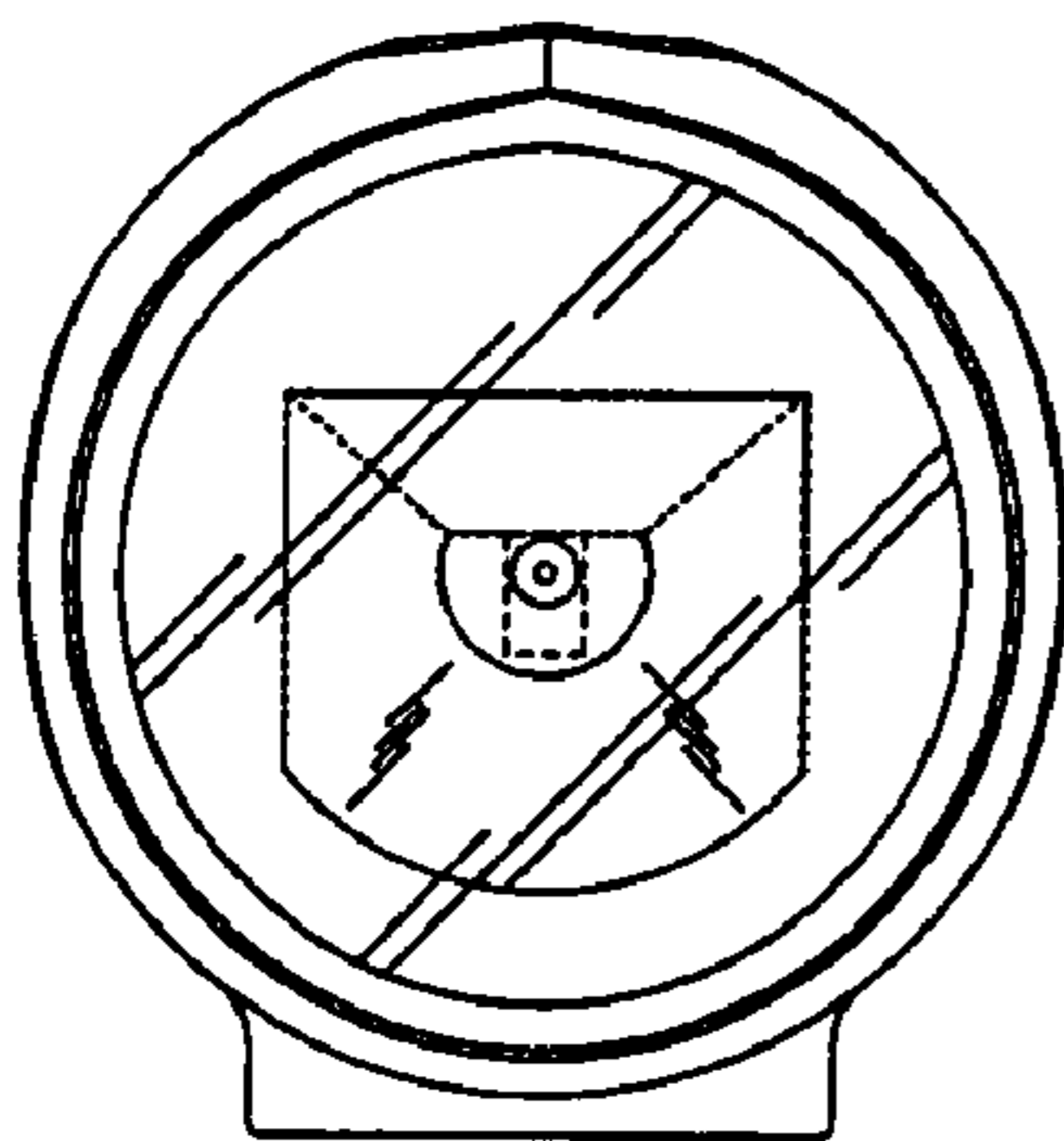

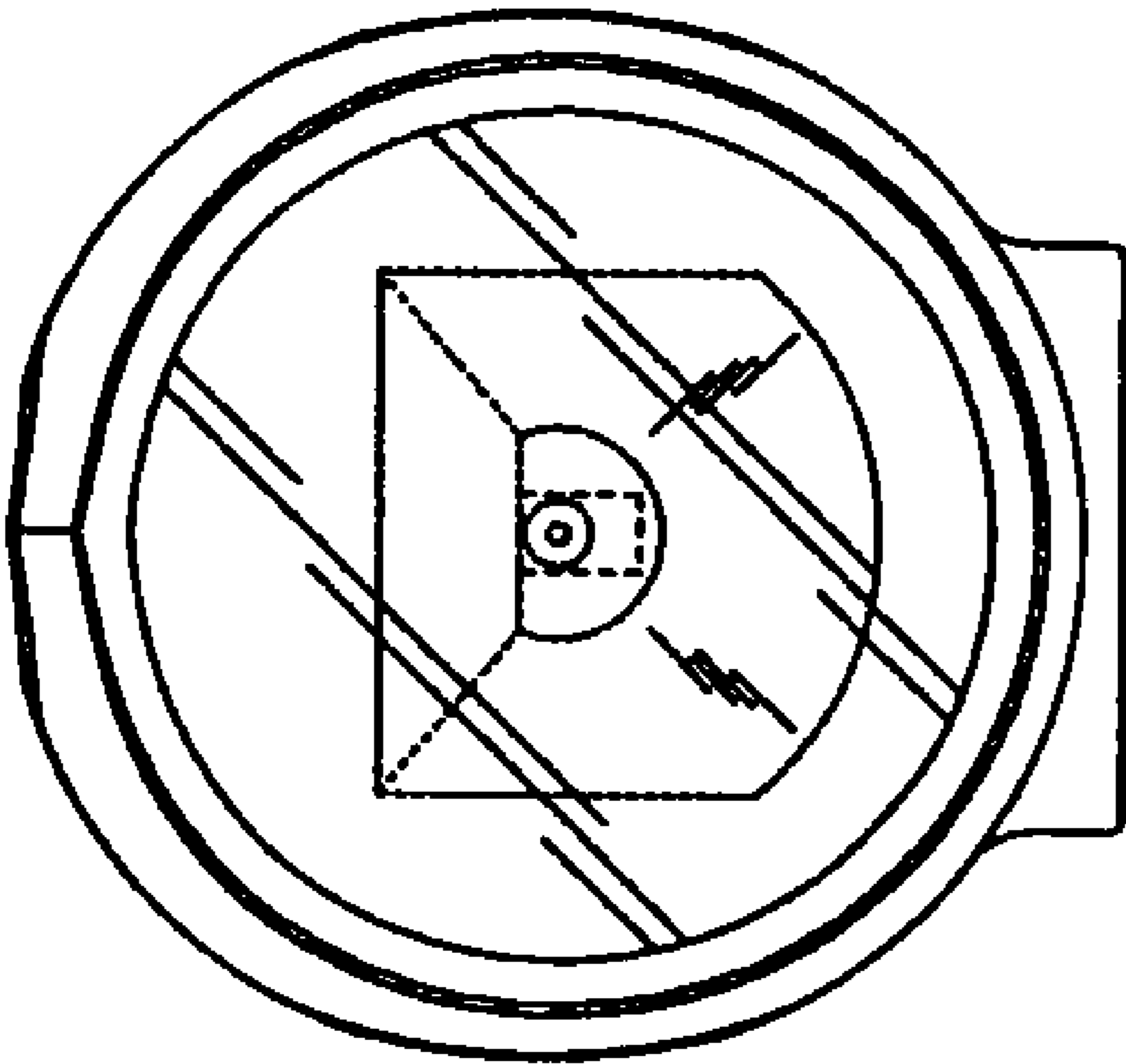

Fig. 1

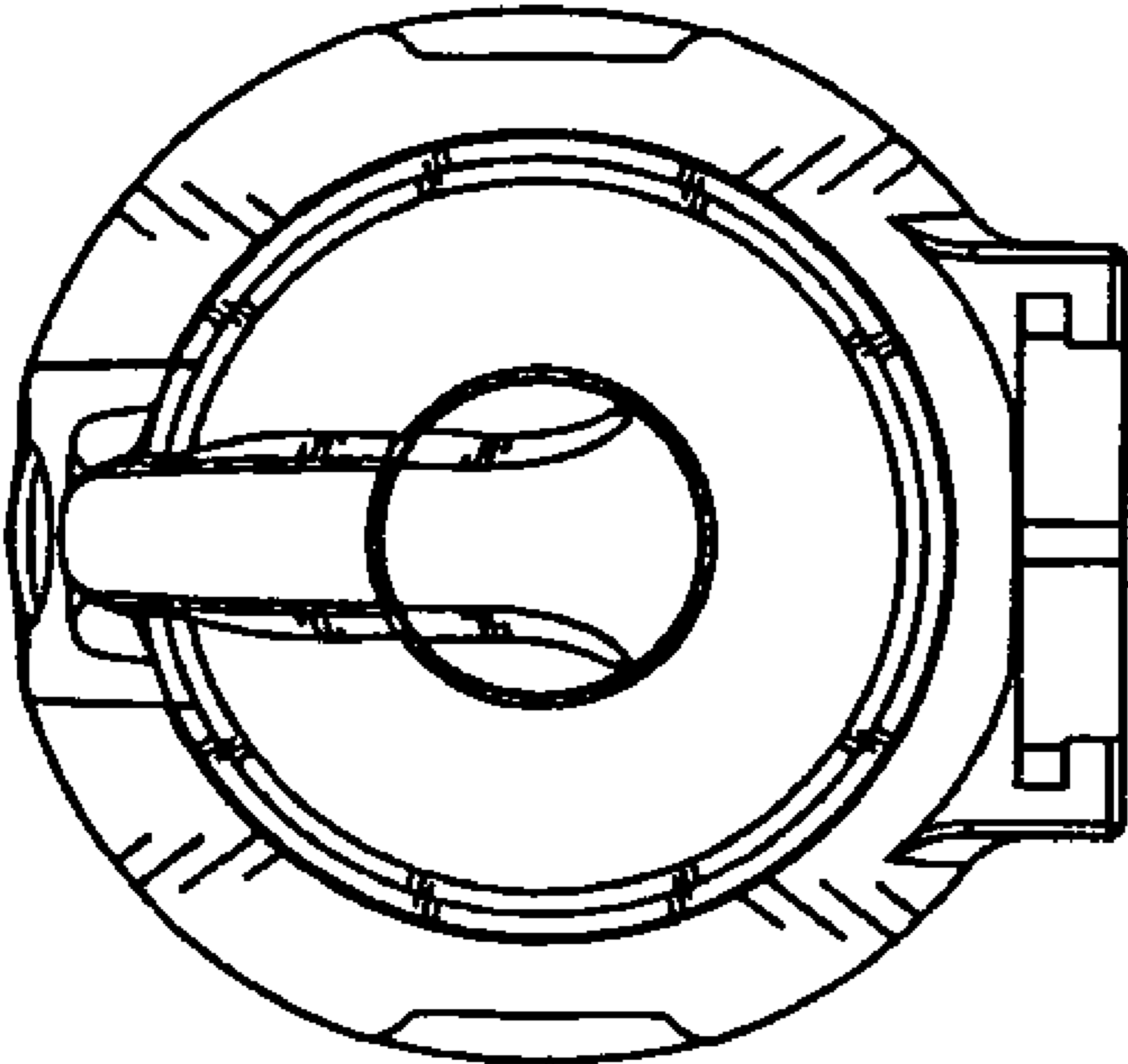

Fig. 2

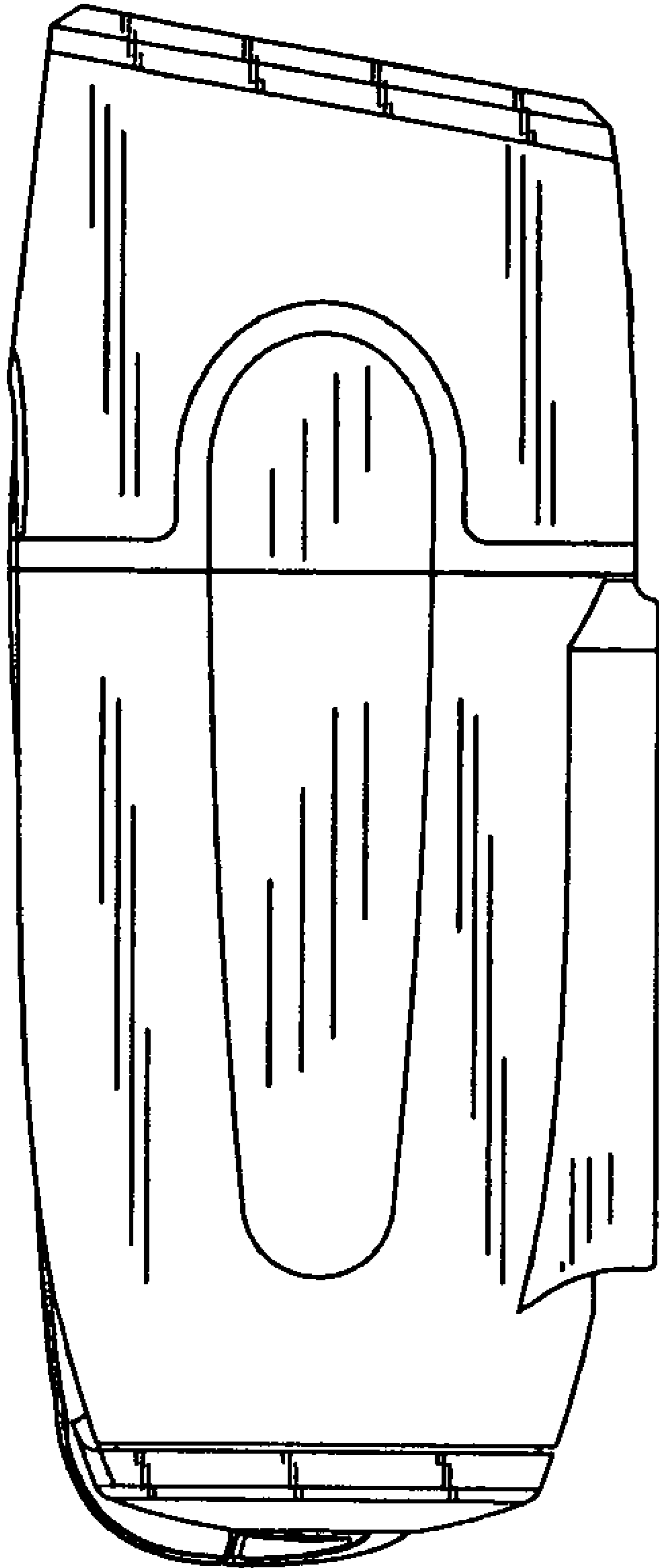

Fig. 3

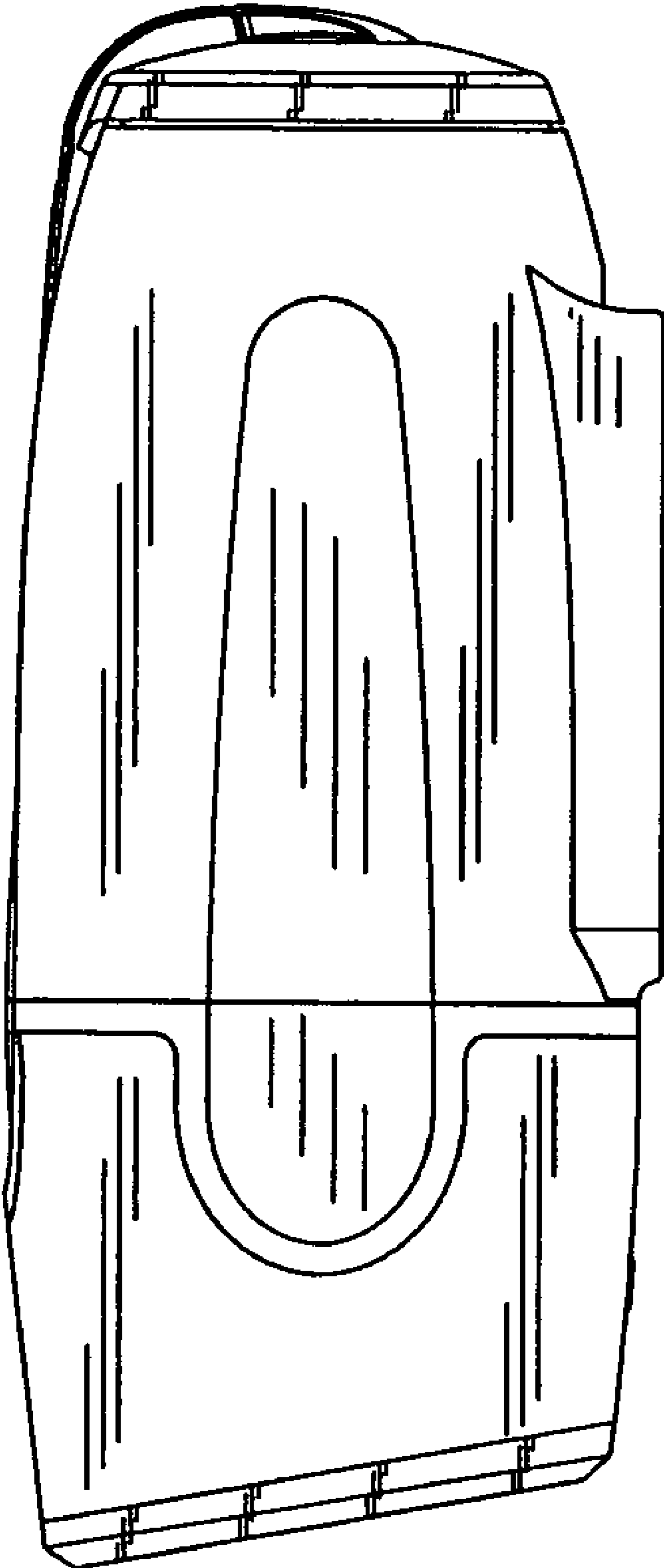

Fig. 4

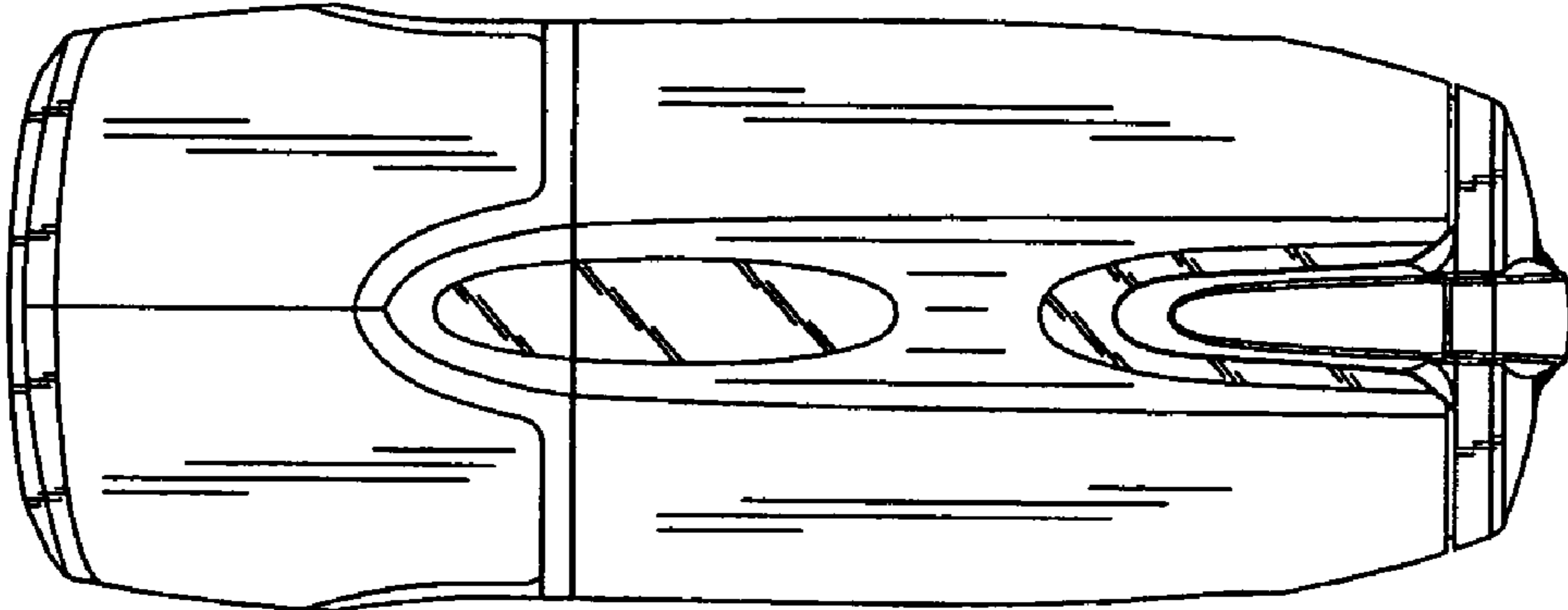

Fig. 5

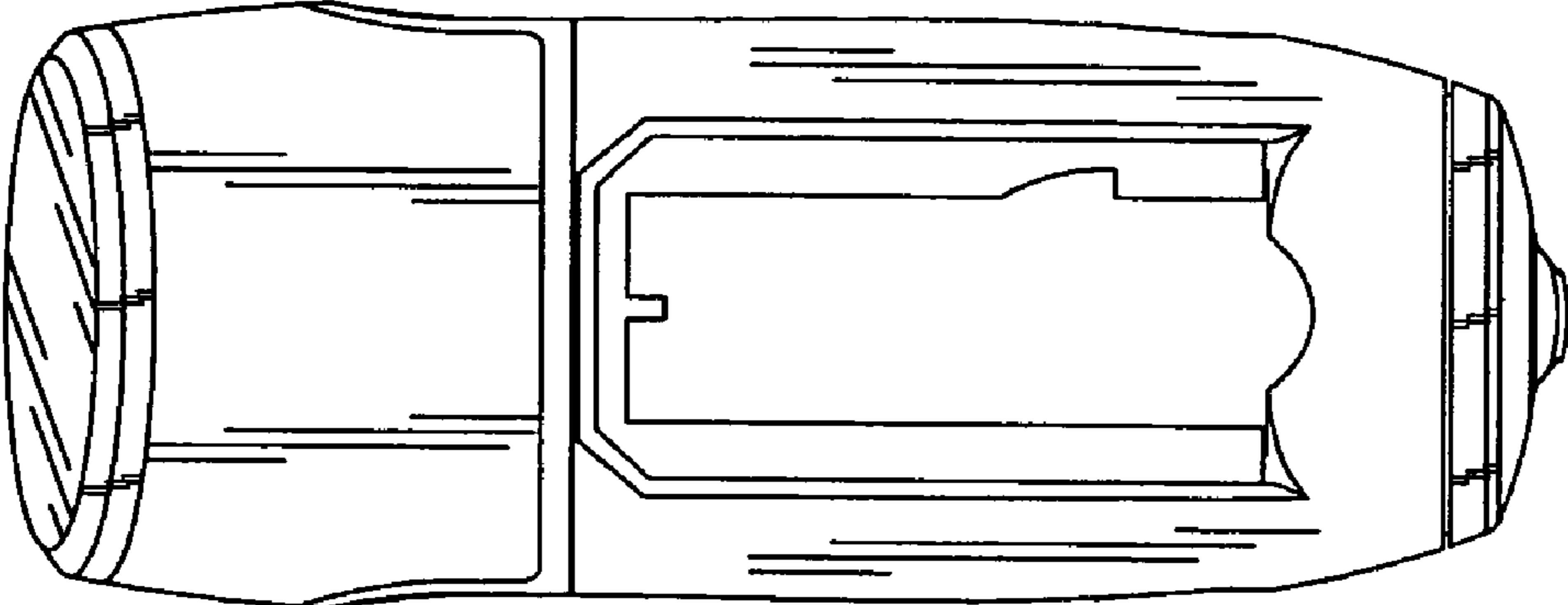

Fig. 6