



US00D588589S

(12) **United States Design Patent**
Dhondt

(10) **Patent No.:** **US D588,589 S**
(45) **Date of Patent:** **** Mar. 17, 2009**

(54) **SET OF KEYS FOR A HANDSET**
(75) Inventor: **Daniel Dhondt**, Espoo (FI)
(73) Assignee: **Nokia Corporation**, Espoo (FI)
(**) Term: **14 Years**

D558,726 S 1/2008 Wang et al.
D560,629 S 1/2008 Ruohonen et al.
D563,936 S 3/2008 Kim et al.
D564,921 S 3/2008 Cheng
D569,365 S 5/2008 Shin et al.
D569,860 S * 5/2008 Pegon et al. D14/247
D571,766 S 6/2008 Christiansen et al.

(21) Appl. No.: **29/304,170**
(22) Filed: **Feb. 26, 2008**

(Continued)

FOREIGN PATENT DOCUMENTS

(30) **Foreign Application Priority Data**
Aug. 28, 2007 (EM) 000779780

WO DM068673 2/2007

(Continued)

OTHER PUBLICATIONS

(51) **LOC (9) Cl.** **14-03**
(52) **U.S. Cl.** **D14/247**
(58) **Field of Classification Search** D14/137,
D14/138 R, 138 AA, 138 AB, 138 AC, 138 AD,
D14/138 C, 138 G, 147, 191, 218, 247-248,
D14/341-347, 455, 496; D10/65, 78, 104;
D13/168; D18/7; 455/556.1, 566, 575.1,
455/575.3; 345/169

Toshiba TS705, announced Sep. 2006, [online], [retrieved on Oct. 6, 2008]. Retrieved from Internet ,<URL: <http://www.gsmarena.com>>.*

(Continued)

Primary Examiner—Jeffrey D Asch
Assistant Examiner—Bridget L Eland
(74) *Attorney, Agent, or Firm*—Banner & Witcoff Ltd.

See application file for complete search history.

(56) **References Cited**

(57) **CLAIM**

U.S. PATENT DOCUMENTS

The ornamental design for a set of keys for a handset, as shown and described.

D464,961 S 10/2002 Sogabe
D496,645 S 9/2004 Yoo et al.
D498,736 S 11/2004 Lee
D503,164 S 3/2005 Park et al.
D519,998 S 5/2006 Park
D523,445 S 6/2006 Toh
D524,802 S * 7/2006 Burns et al. D14/247
D526,301 S 8/2006 Shin
D527,366 S 8/2006 Lee
D535,275 S * 1/2007 Kim et al. D14/138 AD
D538,770 S * 3/2007 Lyles D14/138 AA
D544,460 S 6/2007 Yau
D545,289 S 6/2007 Wang
D548,714 S 8/2007 Kim et al.
D551,647 S 9/2007 Kim et al.
D553,111 S 10/2007 Holmung et al.
D555,616 S 11/2007 Lin
D558,724 S 1/2008 Hsu et al.

DESCRIPTION

FIG. 1 is a perspective front view of a set of keys for a handset showing my new design;
FIG. 2 is a front view thereof;
FIG. 3 is a right side view thereof;
FIG. 4 is a left side view thereof;
FIG. 5 is a top view thereof; and,
FIG. 6 is a bottom view thereof.

The broken line showing various regions of the handset is for illustrative purposes only and forms no part of the claimed design.

1 Claim, 4 Drawing Sheets

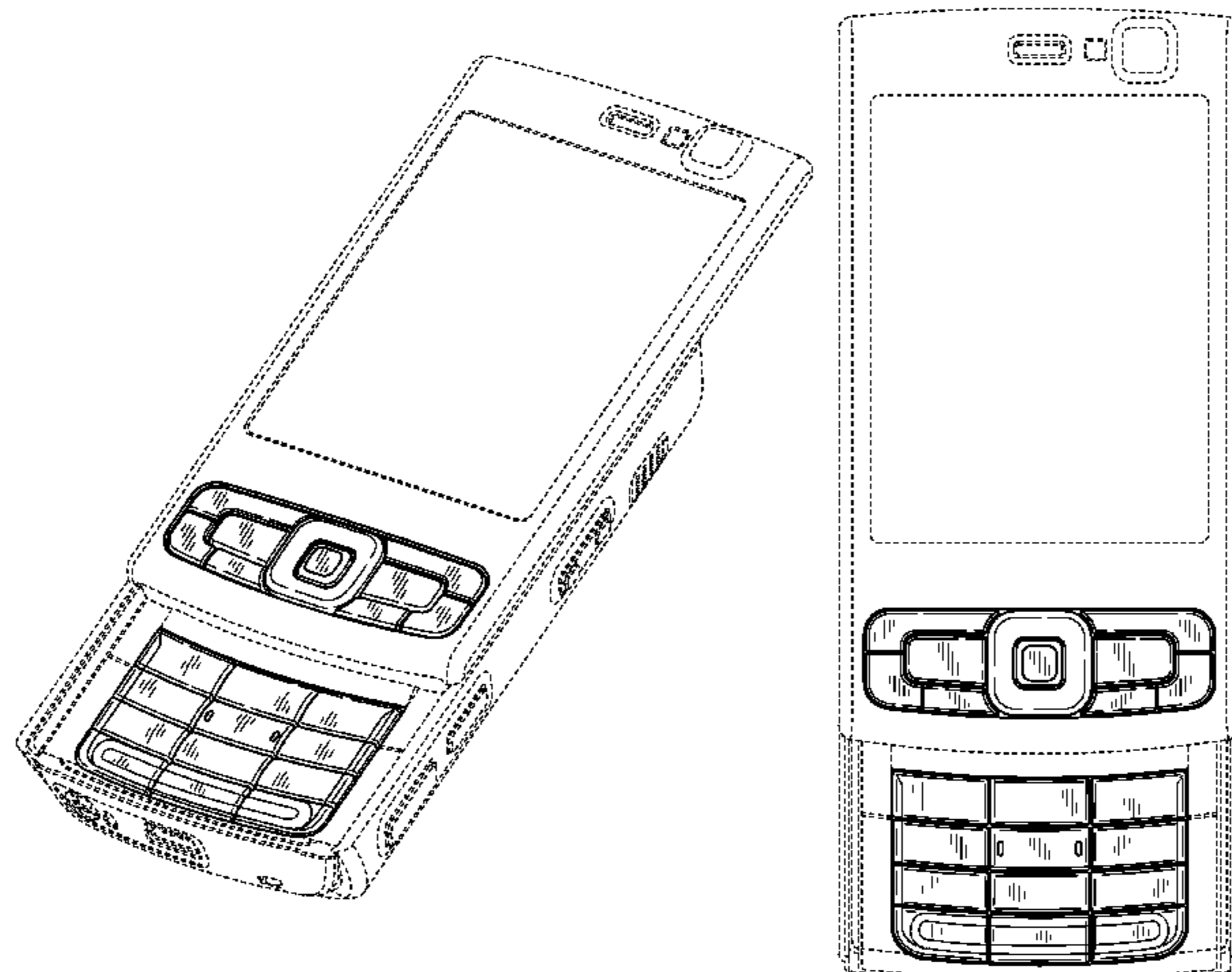

US D588,589 S

Page 2

U.S. PATENT DOCUMENTS

D576,589 S * 9/2008 Montin et al. D14/138 AA
D576,590 S * 9/2008 Benoit D14/138 AD
D576,591 S * 9/2008 Aarras D14/138 AA
D576,994 S * 9/2008 Oh et al. D14/138 AA
2005/0090298 A1 4/2005 Park et al.
2005/0124381 A1* 6/2005 Kim et al. 455/556.1
2006/0166713 A1 7/2006 Yeh et al.
2007/0273786 A1 11/2007 Ahn et al.
2007/0275773 A1 11/2007 Joung et al.
2007/0287512 A1 12/2007 Kilpi et al.
2008/0207272 A1 8/2008 Thornton et al.

FOREIGN PATENT DOCUMENTS

WO DM/069161 * 7/2007
WO DM070068 2/2008

OTHER PUBLICATIONS

Nokia E71, announced Jun. 2008, [online], [retrieved on Oct. 17, 2008]. Retrieved from Internet ,<URL: <http://www.gsmarena.com>>.*

Internet printout: www.gsmarena.com, Nokia N95 8 GB, announced Aug. 2007 (online), dated Sep. 4, 2007.

Internet printout: www.gsmarena.com, Nokia N95, announced Sep. 2006 (online), dated Feb. 16, 2007.

Internet printout: www.gsmarena.com, Nokia N80, announced 4th quarter 2005, (online), dated Feb. 16, 2007.

Internet printout: www.gsmarena.com, Eten glofish X610, announced Jun. 2008 (online), dated Jun. 13, 2008.

Internet printout: www.gsmarena.com, Eten glofish X600, announced Oct. 2007 (online), dated Dec. 13, 2007.

Internet printout: www.gsmarena.com, Ben-Q-Siemens CL71, announced Mar. 2006 (online), dated Feb. 16, 2007.

Internet printout: www.gsmarena.com, Asus P550, announced Dec. 2007 (online), dated Jan. 18, 2008.

Internet printout: www.gsmarena.com, Asus P535, announced Nov. 2006 (online), dated Feb. 20, 2007.

* cited by examiner

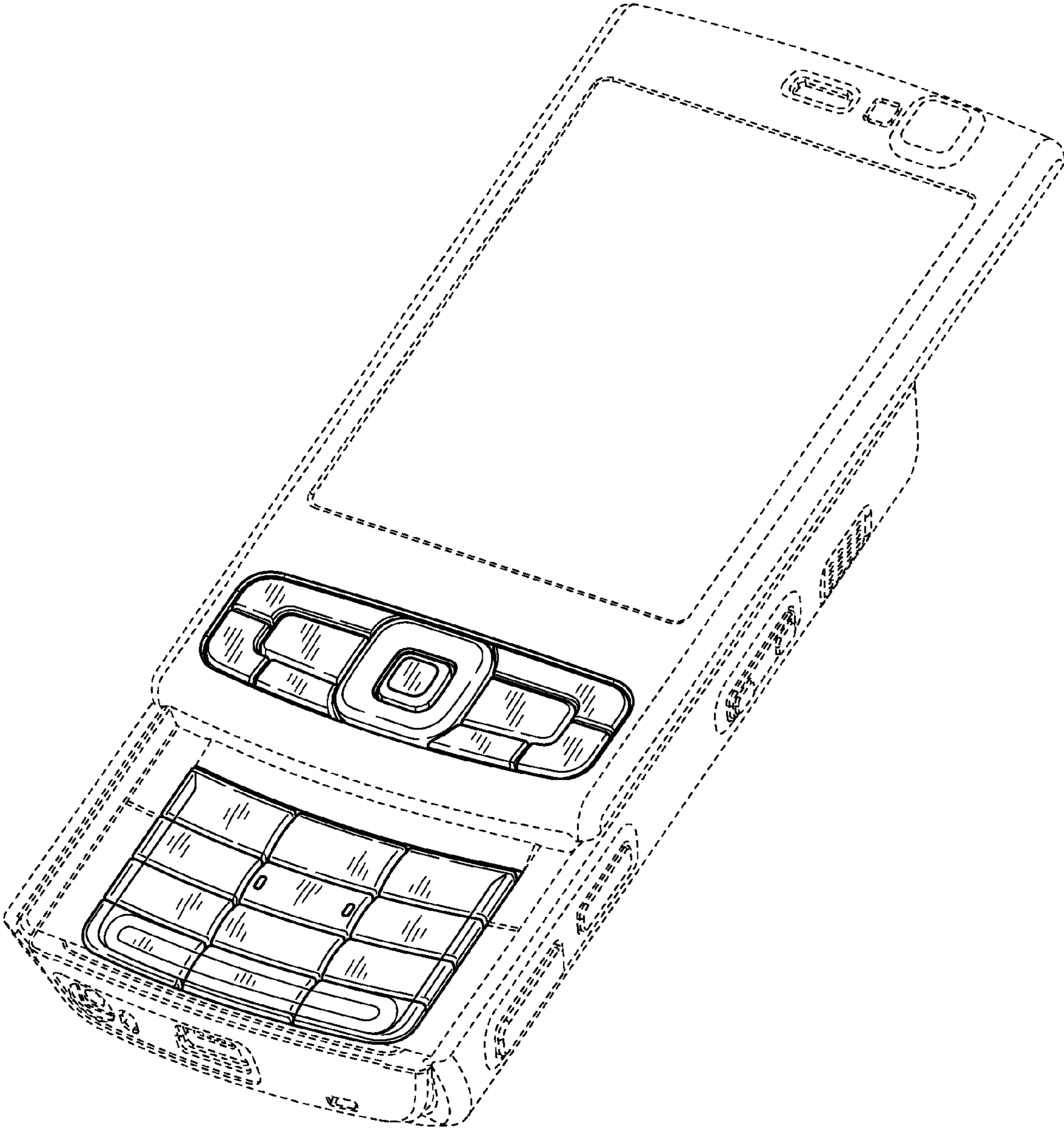

FIG. 1

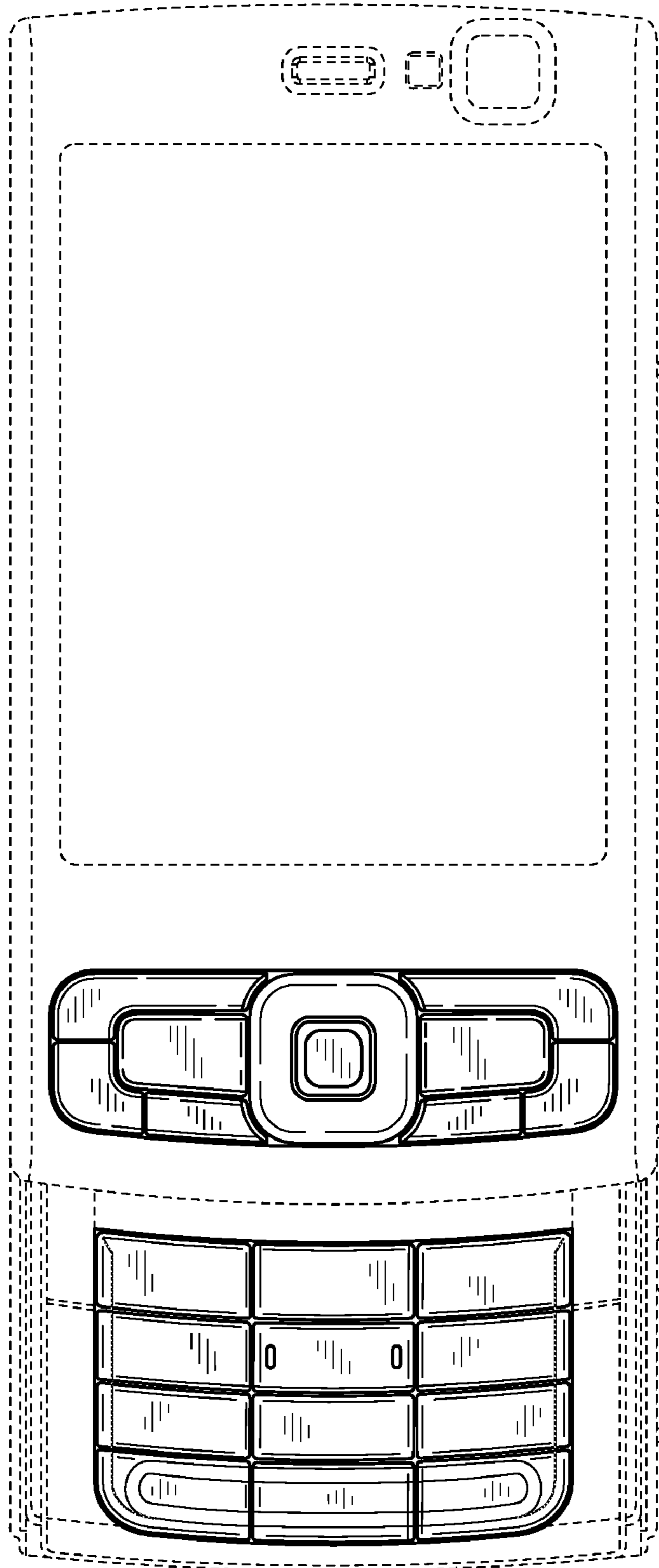

FIG. 2

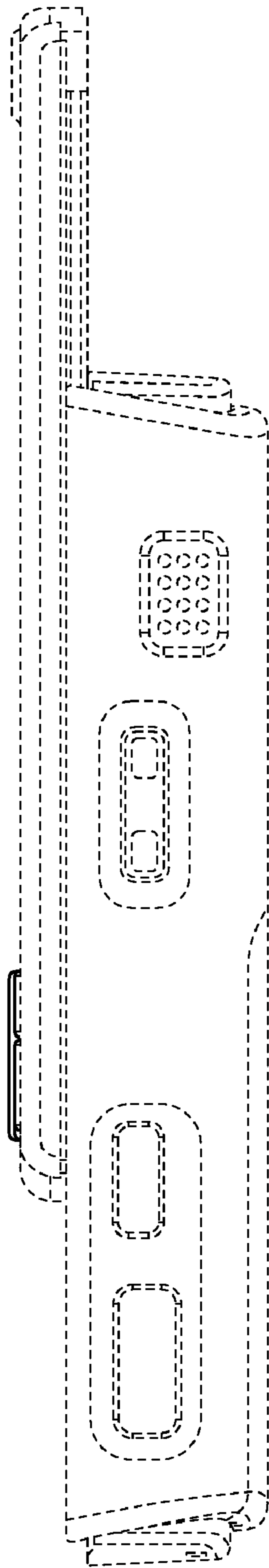

FIG. 3

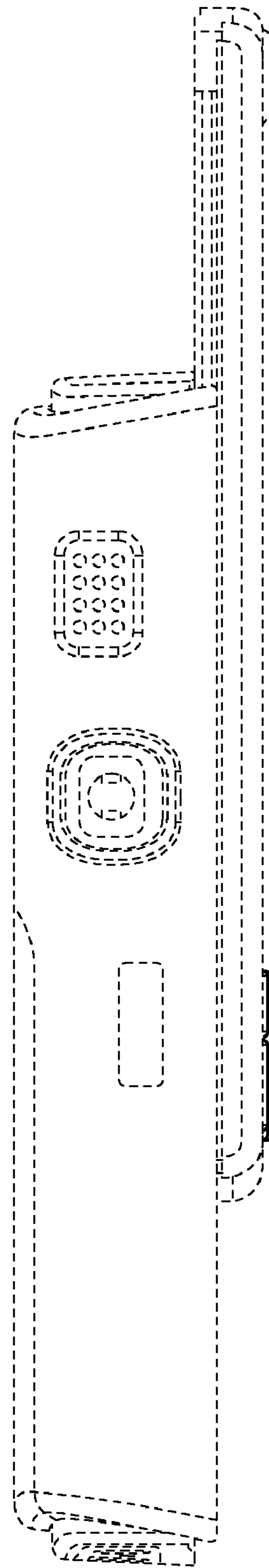

FIG. 4

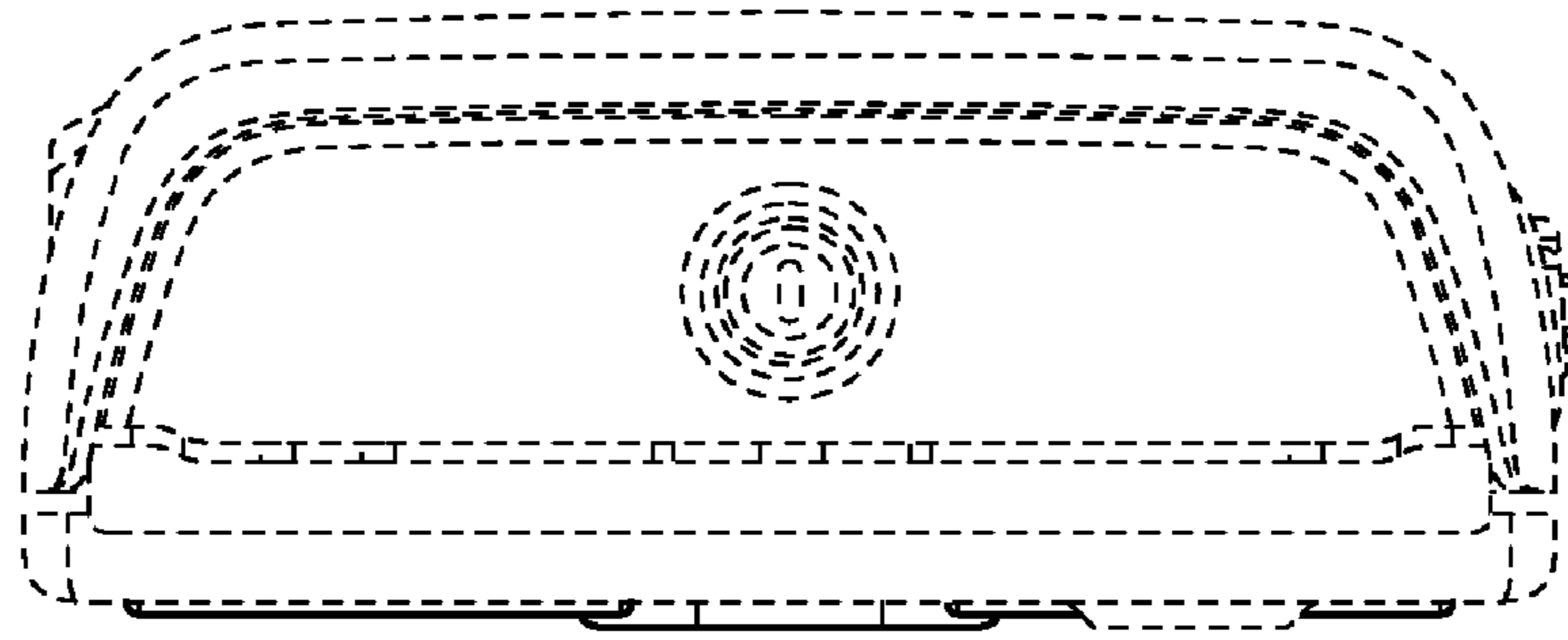

FIG. 5

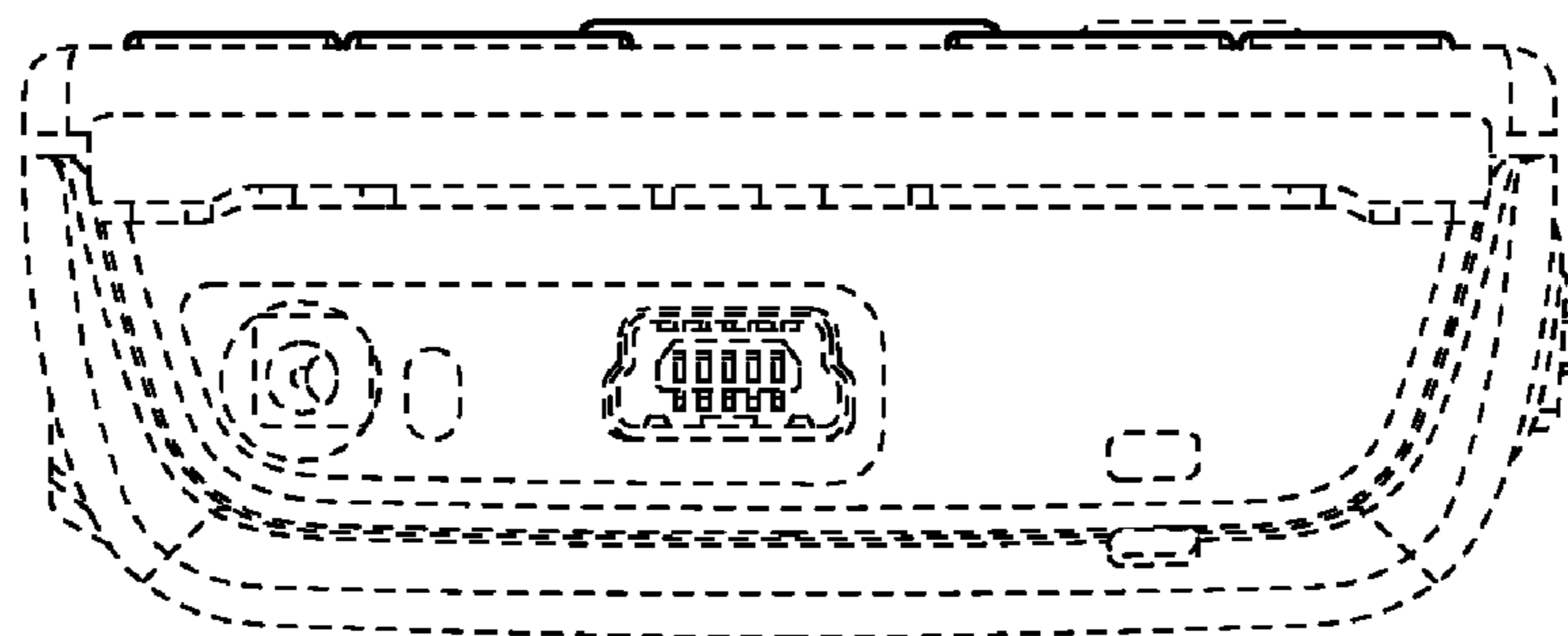

FIG. 6