



US00D588585S

(12) **United States Design Patent**
Montgomery et al.

(10) **Patent No.:** **US D588,585 S**

(45) **Date of Patent:** **** Mar. 17, 2009**

(54) **ANTENNA STRUCTURE**

(75) Inventors: **Mark T. Montgomery**, Melbourne Beach, FL (US); **Li Chen**, Melbourne, FL (US)

(73) Assignee: **SkyCross, Inc.**, Viera, FL (US)

(**) Term: **14 Years**

(21) Appl. No.: **29/281,430**

(22) Filed: **Jun. 22, 2007**

(51) **LOC (9) Cl.** **14-03**

(52) **U.S. Cl.** **D14/230**

(58) **Field of Classification Search** D14/218,
D14/230, 231, 238, 232, 234, 235, 237; 343/878,
343/880, 840, 872, 881, 763, 720, 912, 908,
343/907, 761, 882, 786, 884

See application file for complete search history.

(56) **References Cited**

U.S. PATENT DOCUMENTS

5,243,357	A *	9/1993	Koike et al.	343/776
5,845,391	A *	12/1998	Bellus et al.	29/600
5,990,835	A *	11/1999	Kuntzsch et al.	343/700 MS
6,563,398	B1 *	5/2003	Wu	333/137
6,795,029	B2 *	9/2004	Baker	343/702
6,897,824	B2 *	5/2005	Gerhard	343/776
D555,154	S *	11/2007	Lin et al.	D14/230
D555,155	S *	11/2007	Su et al.	D14/230
D573,589	S *	7/2008	Montgomery et al.	D14/230
2008/0258991	A1 *	10/2008	Montgomery et al.	343/844

* cited by examiner

Primary Examiner—T. Chase Nelson
Assistant Examiner—Ania K Dworzecka

(74) *Attorney, Agent, or Firm*—Rajesh Vallabh; Foley Hoag LLP

(57) **CLAIM**

The ornamental design for an antenna structure, as shown and described.

DESCRIPTION

FIG. 1 is a perspective view of a first embodiment of an antenna structure showing our new design;

FIG. 2 is an inverted rear elevational view thereof;

FIG. 3 is a front elevational view thereof;

FIG. 4 is a top plan view thereof;

FIG. 5 is a bottom plan view thereof;

FIG. 6 is a left side elevational view thereof;

FIG. 7 is a right side elevational view thereof;

FIG. 8 is a perspective view of a second embodiment of an antenna structure;

FIG. 9 is an inverted rear elevational view thereof;

FIG. 10 is a top plan view thereof;

FIG. 11 is a front elevational view thereof;

FIG. 12 is a bottom plan view thereof;

FIG. 13 is a left side elevational view thereof; and,

FIG. 14 is a right side elevational view thereof.

The broken lines illustrate environmental structure and form no part of the claimed design.

1 Claim, 4 Drawing Sheets

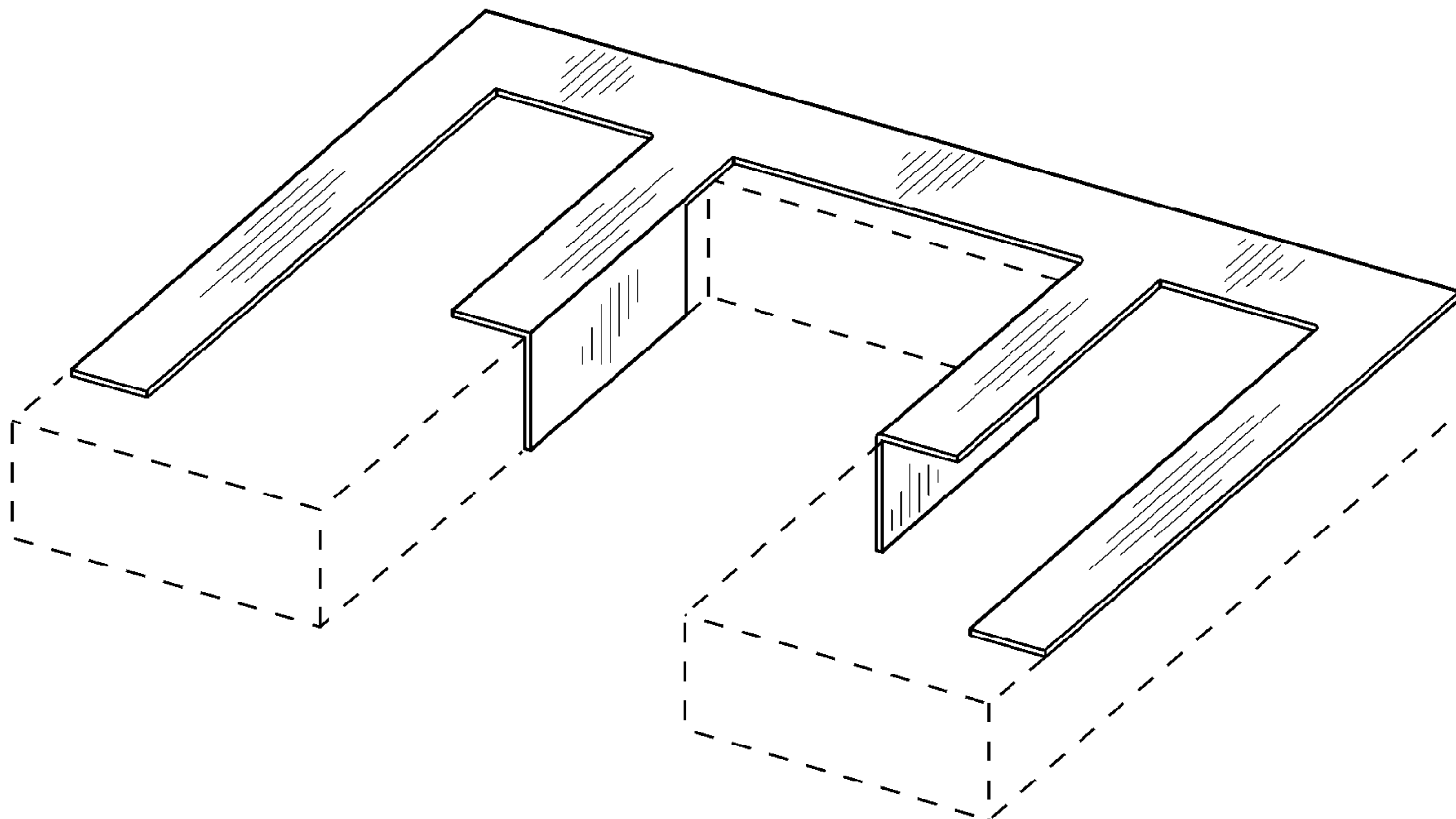

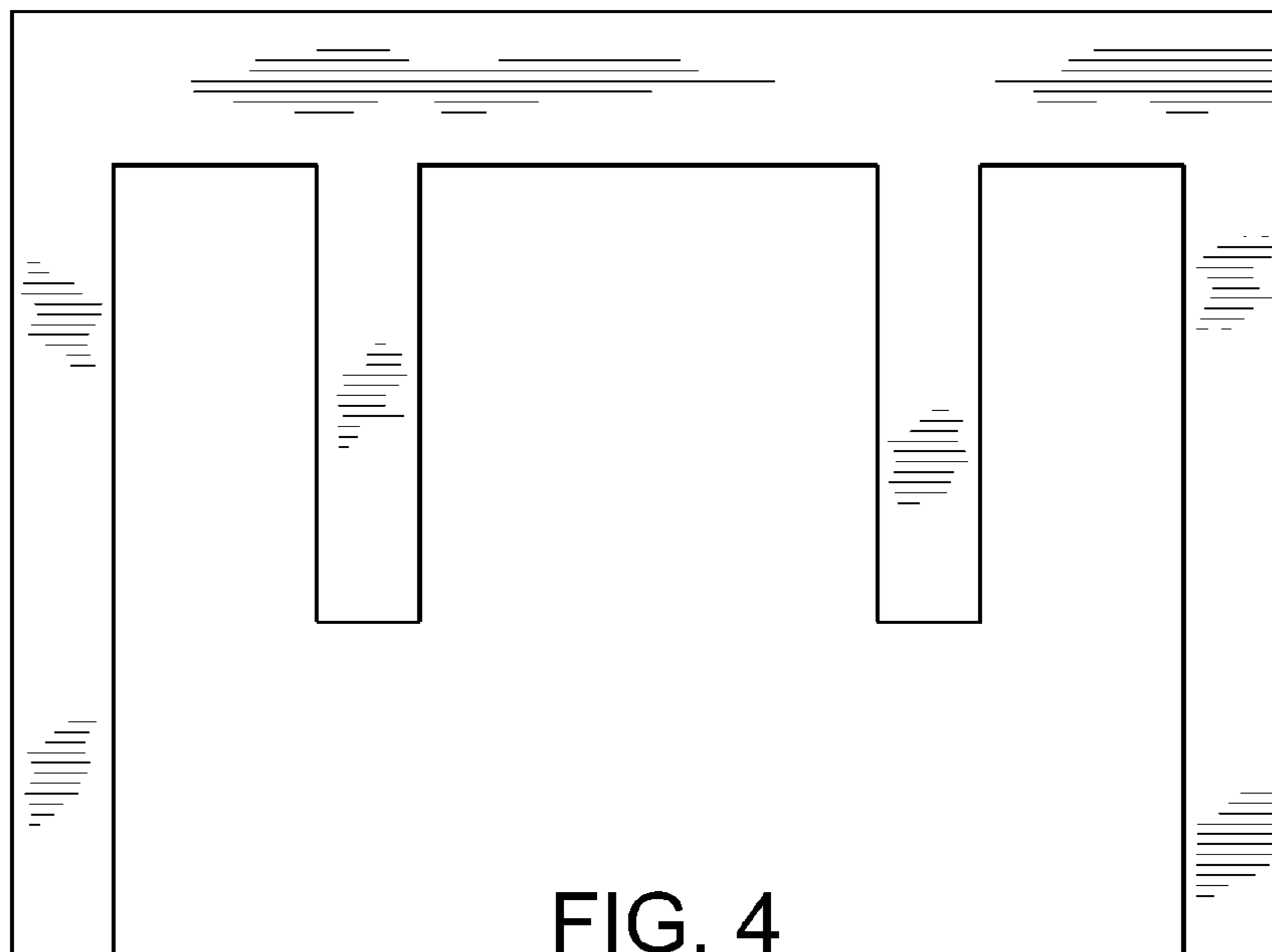
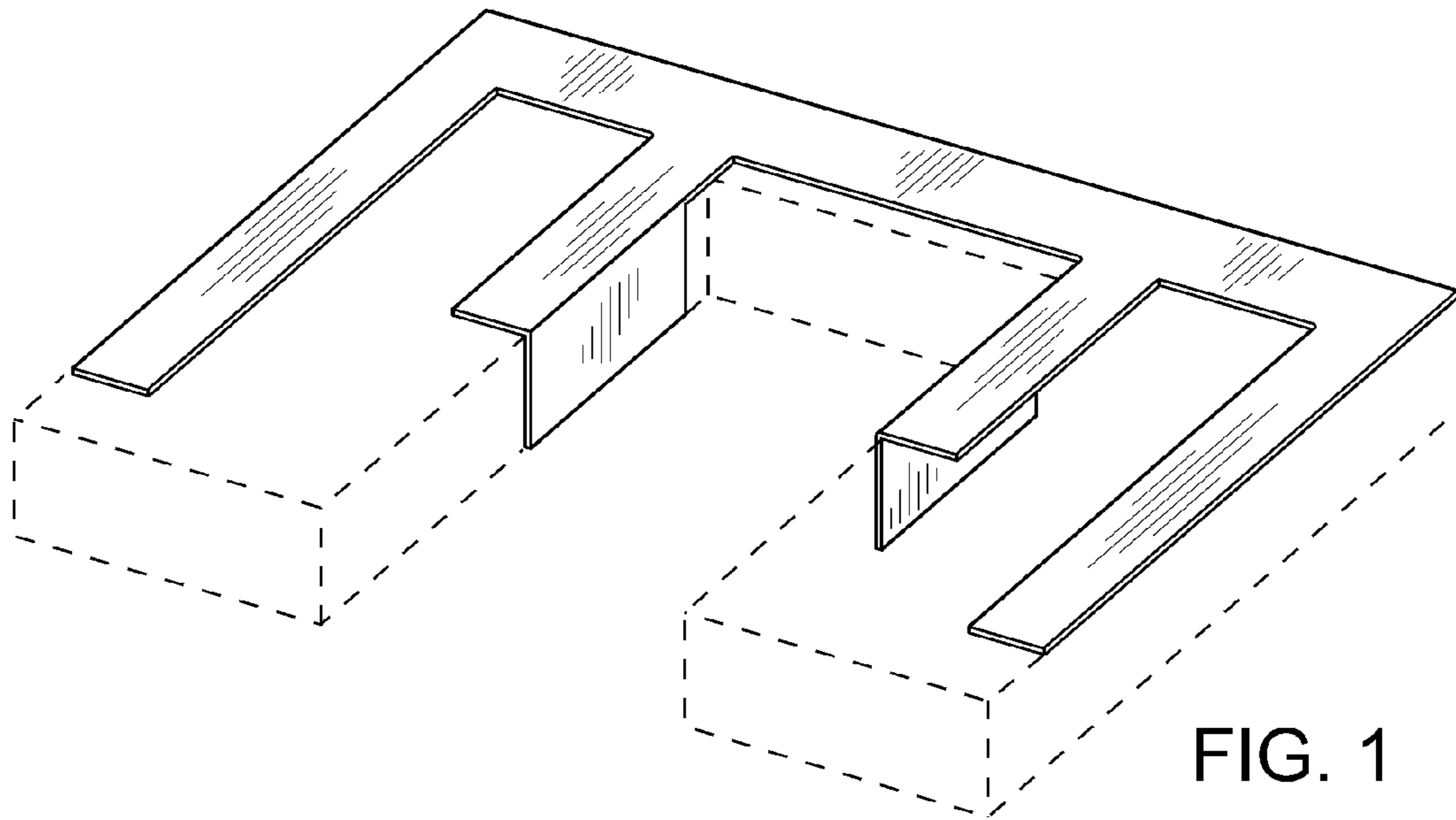

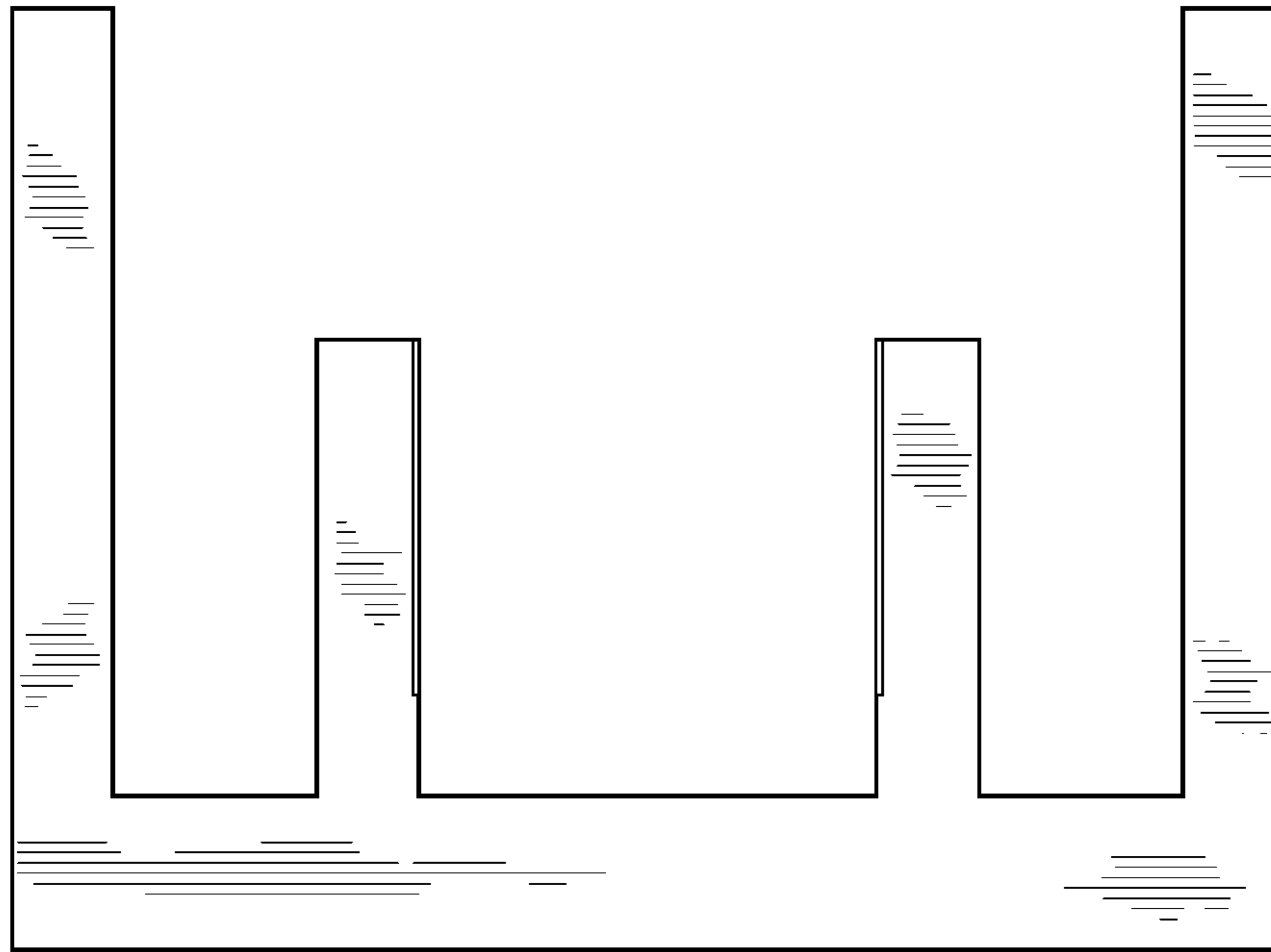

FIG. 5

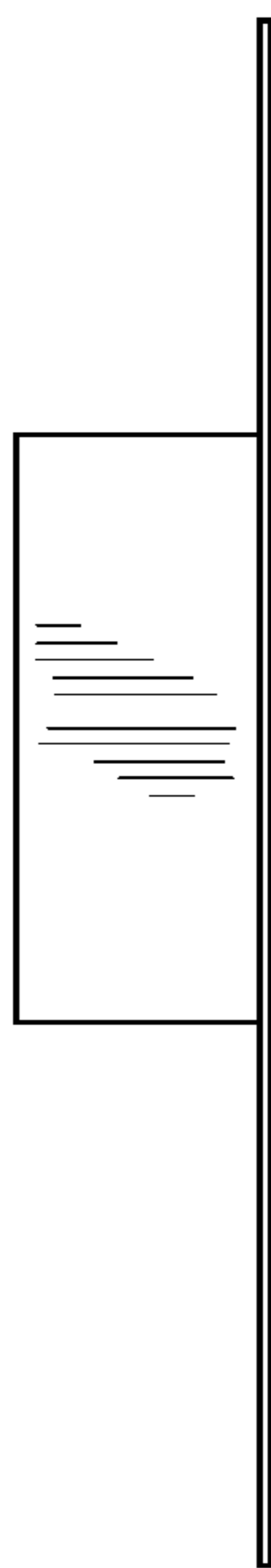

FIG. 6

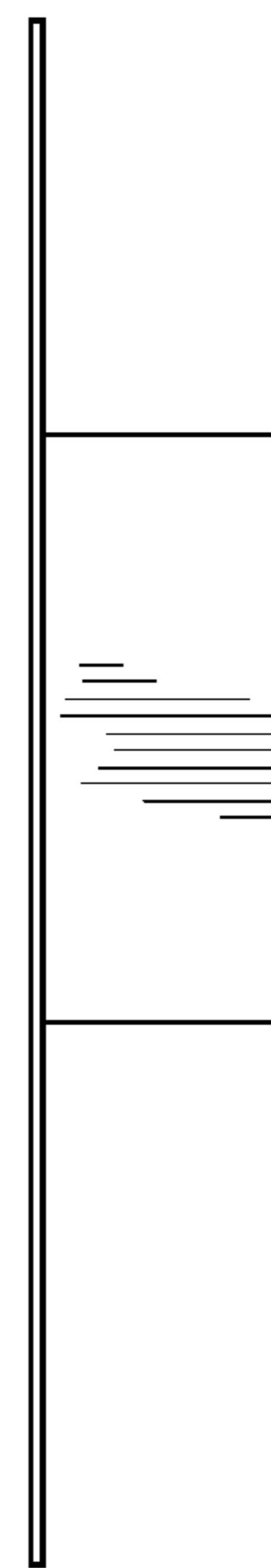
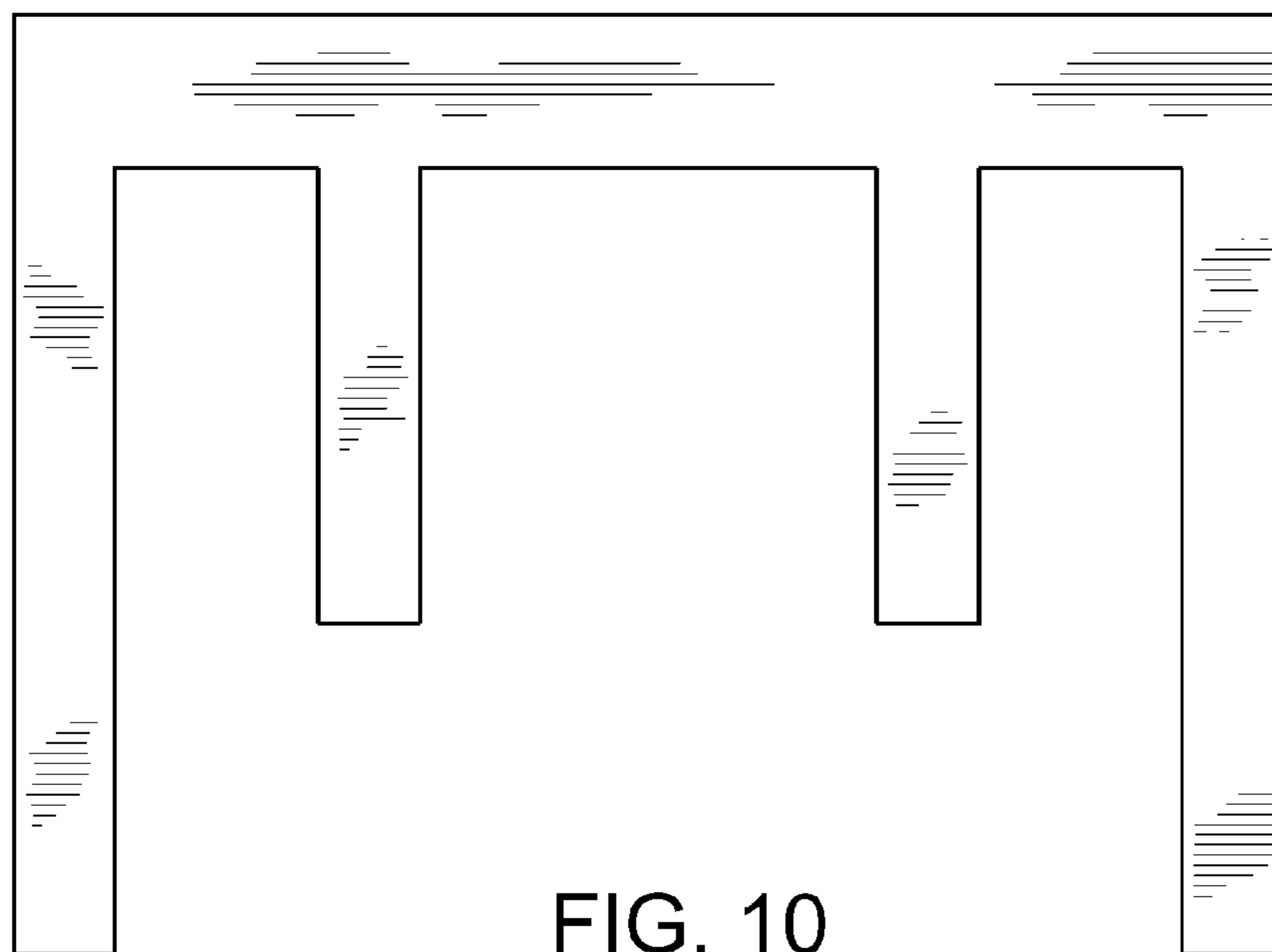
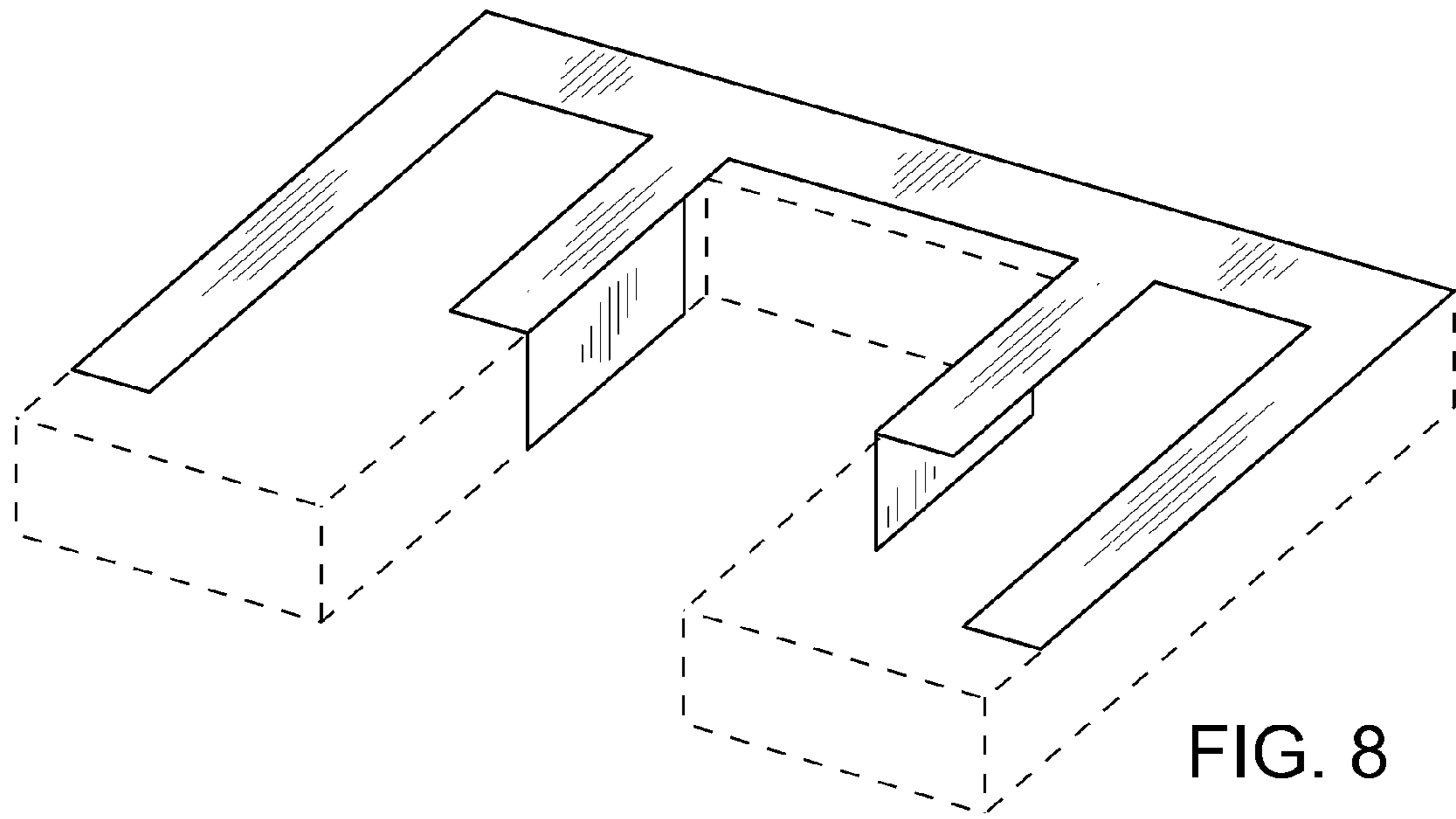

FIG. 7



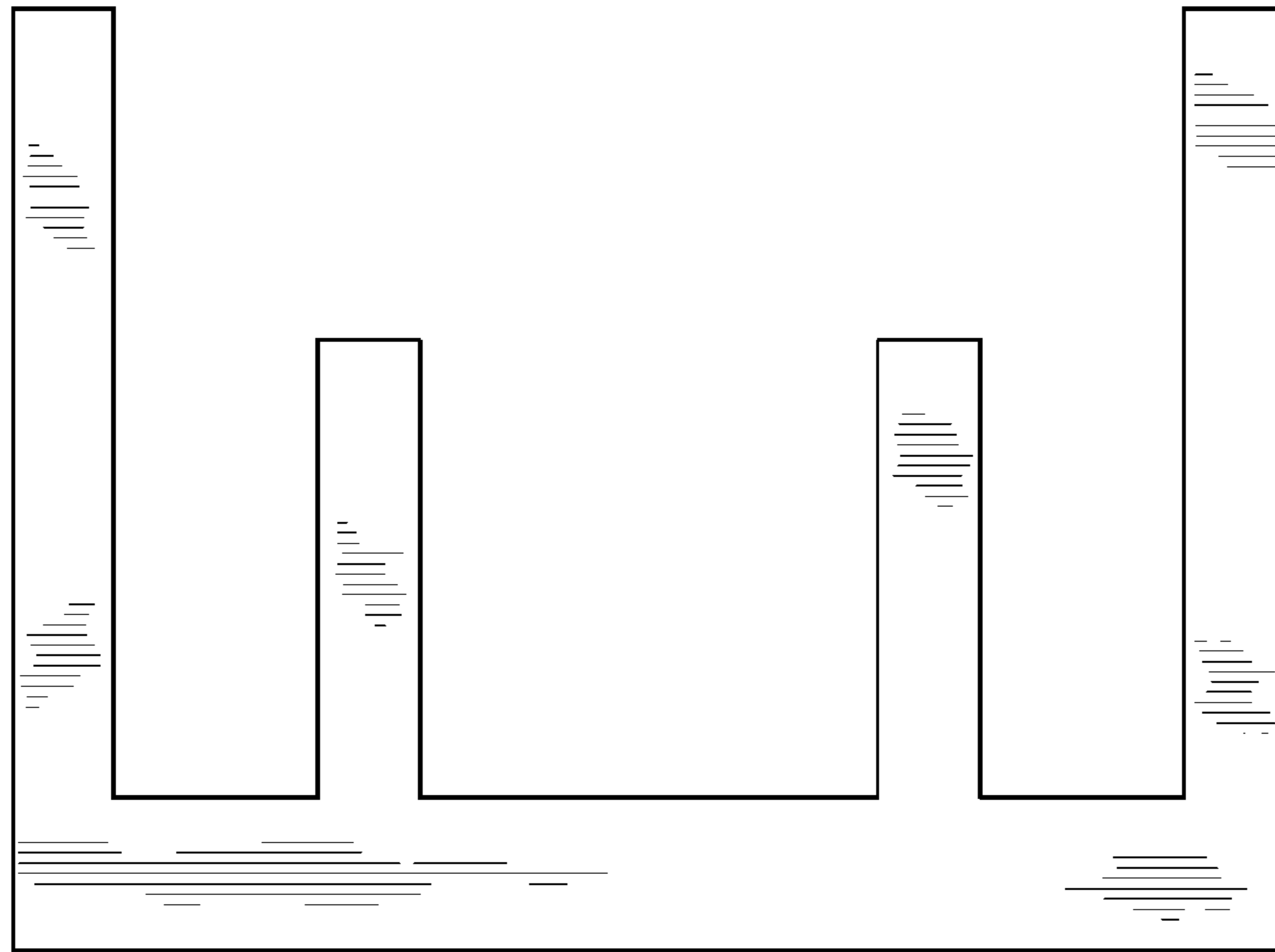

FIG. 12

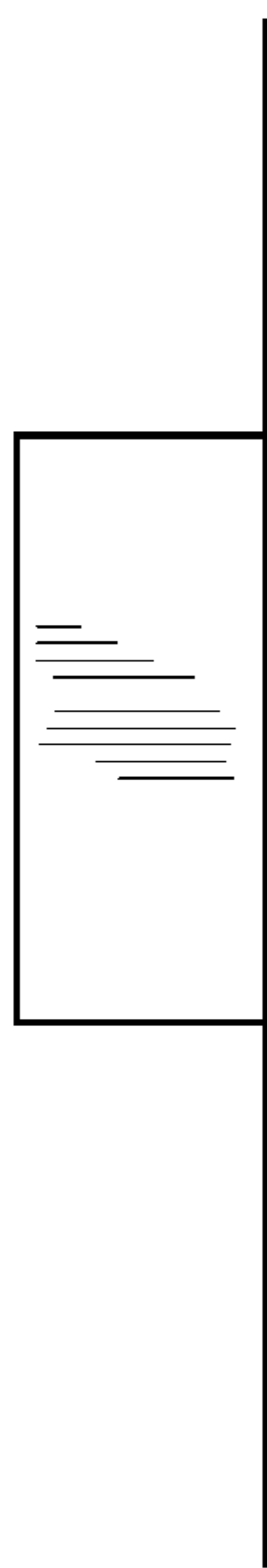

FIG. 13

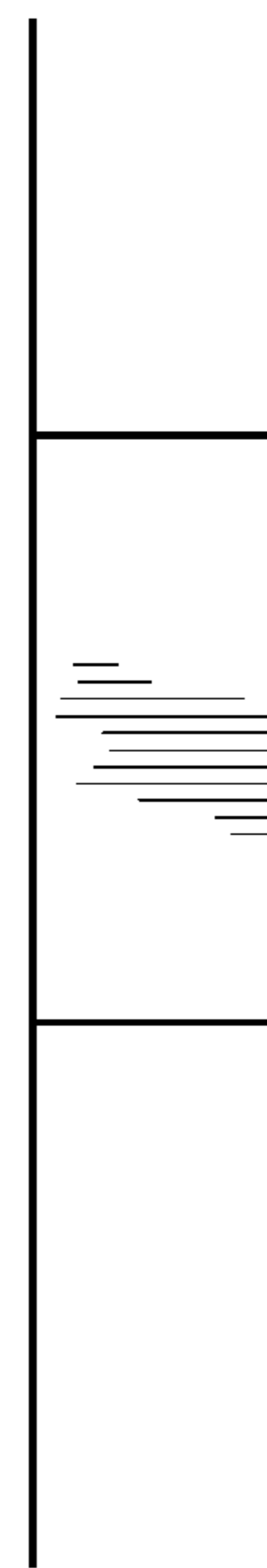

FIG. 14