



US00D588562S

(12) **United States Design Patent**
Yamaguchi

(10) **Patent No.:** **US D588,562 S**
(45) **Date of Patent:** **** Mar. 17, 2009**

(54) **TELEVISION RECEIVER**

(75) Inventor: **Takahiro Yamaguchi**, Chiyoda-Ku (JP)

(73) Assignee: **Mitsubishi Electric Corporation**,
Tokyo (JP)

(**) Term: **14 Years**

(21) Appl. No.: **29/318,276**

(22) Filed: **May 16, 2008**

(30) **Foreign Application Priority Data**

Dec. 20, 2007 (JP) 2007-035026

(51) **LOC (9) Cl.** **14-03**

(52) **U.S. Cl.** **D14/126**

(58) **Field of Classification Search** D14/125–134,
D14/239, 371, 136, 374–377, 440, 450, 448,
D14/336, 342; 312/7.2; 348/836, 838, 180,
348/184, 325, 739; 341/12; 248/917–924,
248/465; 345/104, 133, 156, 168, 87, 173;
720/605, 669, 600, 655; 369/99, 197; D21/329,
D21/515, 577, 622, 333, 433, 448, 452, 450,
D21/331; D6/477, 479; 273/148 B; 446/484,
446/175, 356; D10/15, 26

See application file for complete search history.

(56) **References Cited**

U.S. PATENT DOCUMENTS

D408,416 S * 4/1999 Fenner et al. D14/239
D486,131 S * 2/2004 Otsuka D14/126
D539,766 S * 4/2007 Kita D14/126
D542,750 S * 5/2007 Yeh et al. D14/126

D558,736 S * 1/2008 Kita D14/214
D566,066 S * 4/2008 Wang D14/126
D572,682 S * 7/2008 Won et al. D14/126

* cited by examiner

Primary Examiner—Raphael Barkai

(74) *Attorney, Agent, or Firm*—Sughrue Mion, PLLC

(57) **CLAIM**

The ornamental design for a television receiver, as shown and described.

DESCRIPTION

FIG. 1 is a front, top and left side perspective view of a television receiver, showing my new design;

FIG. 2 is a front elevational view thereof;

FIG. 3 is a rear elevational view thereof;

FIG. 4 is a top plan view thereof;

FIG. 5 is a bottom plan view thereof;

FIG. 6 is a left side elevational view thereof;

FIG. 7 is a right side elevational view thereof;

FIG. 8 is an enlarged cross-sectional view thereof; taken along line 8—8 of FIG. 2, with the internal system omitted;

FIG. 9 is an enlarged partial view thereof; taken along line 9—9 of FIG. 2;

FIG. 10 is an enlarged partial perspective view thereof; and, FIG. 11 is a reference view showing the state in use.

The broken lines shown in FIG. 11 are for illustrative purposes only and form no part of the claimed design.

1 Claim, 5 Drawing Sheets

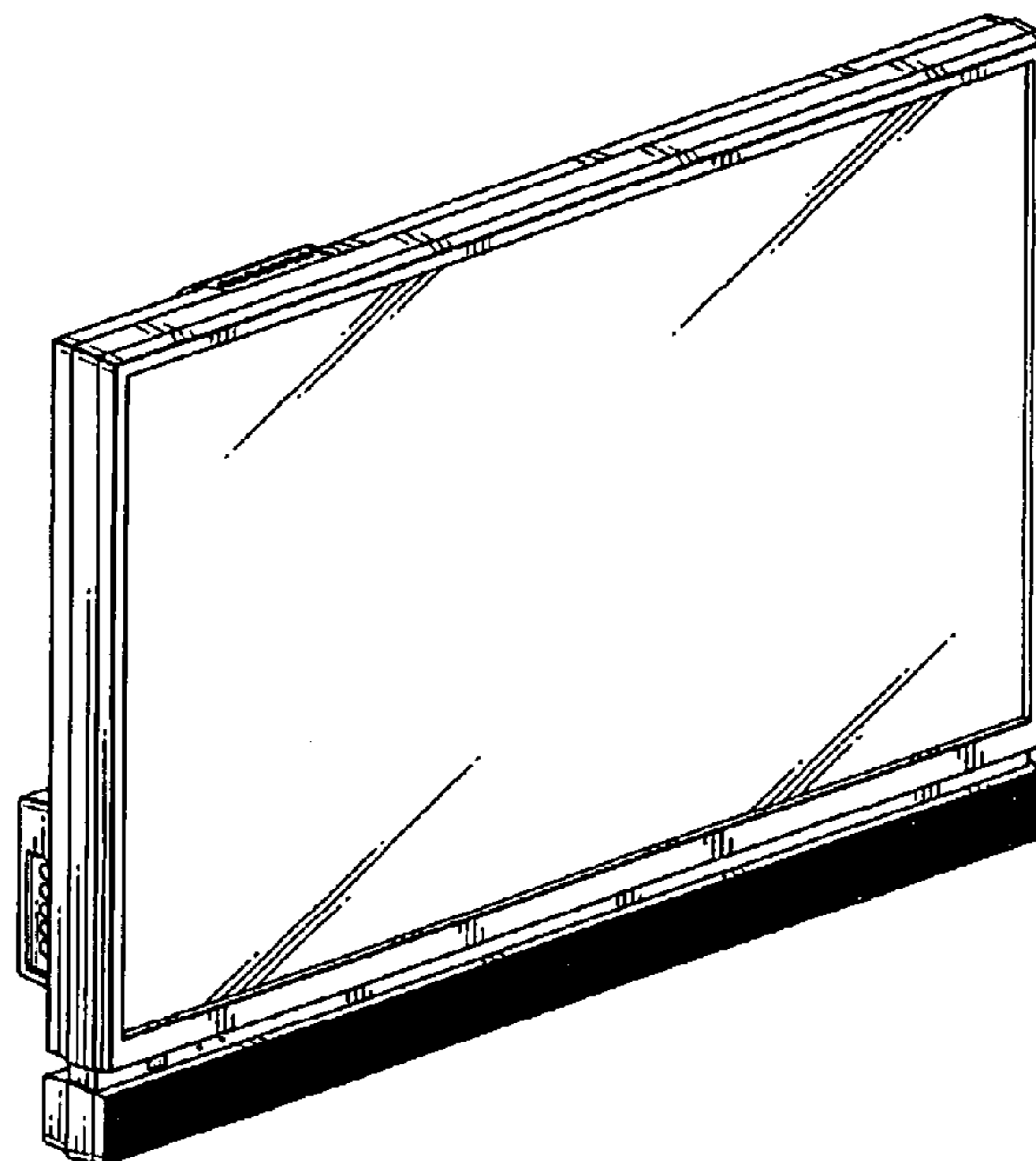

FIG. 1

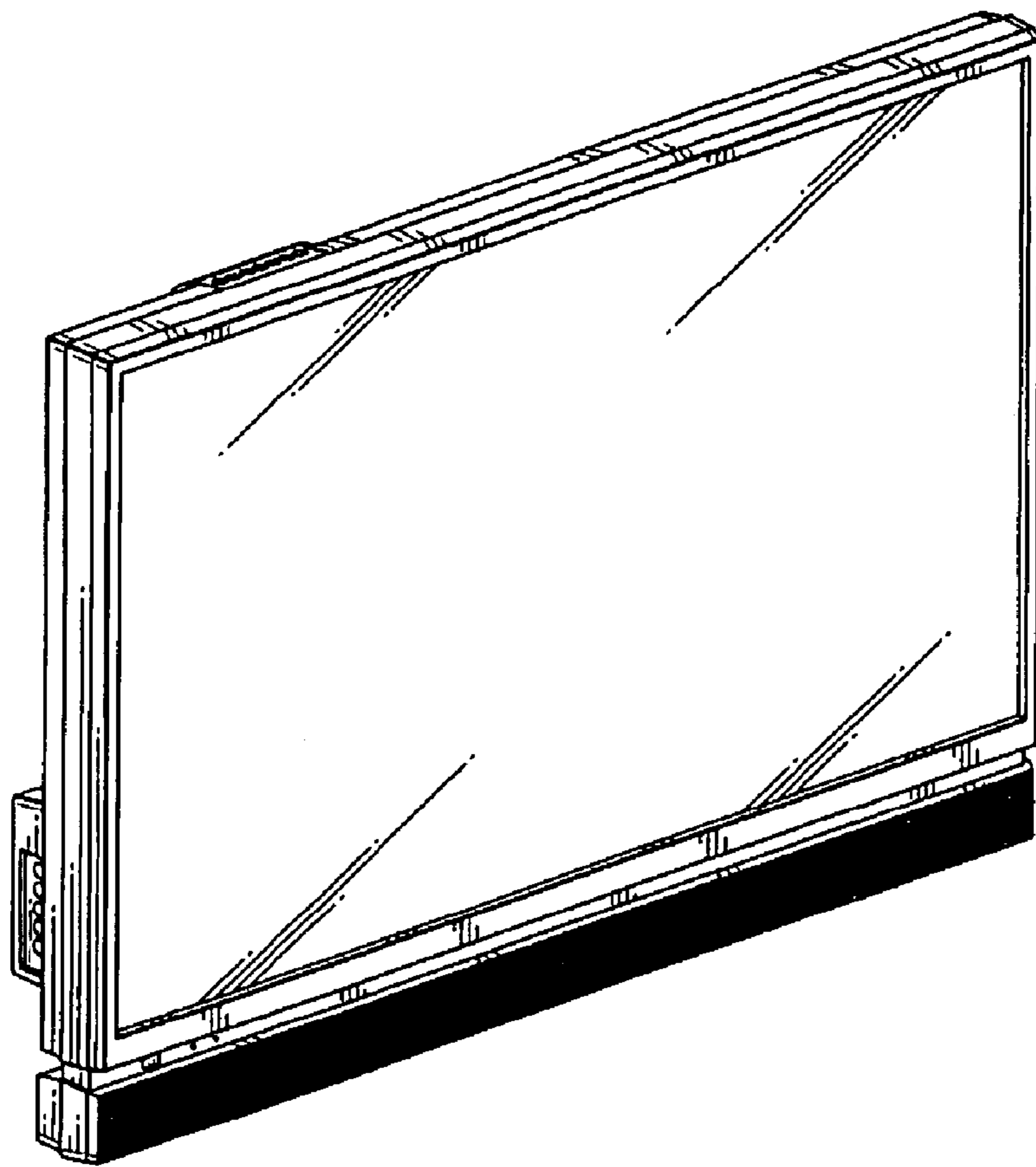

FIG.2

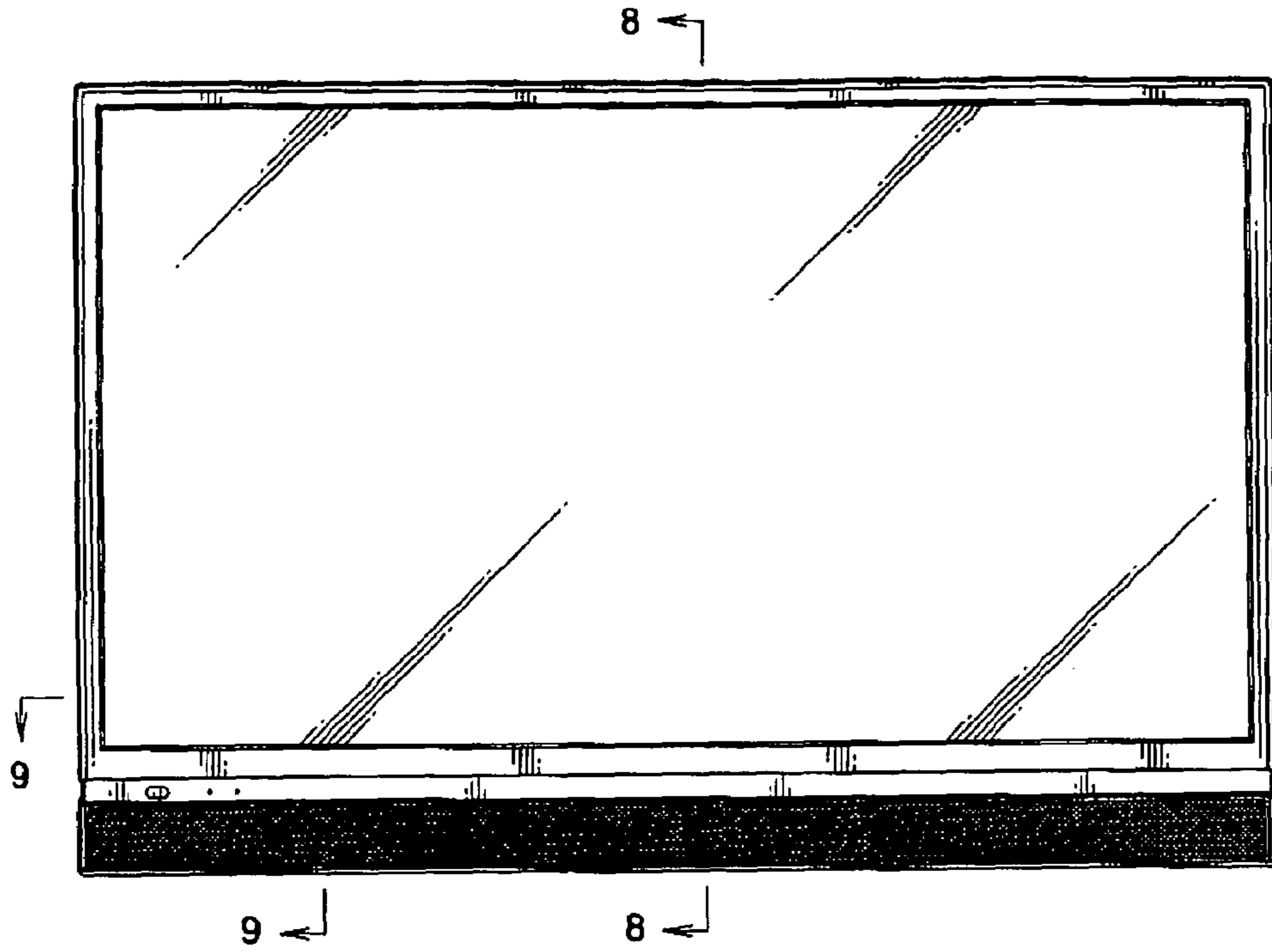

FIG.3

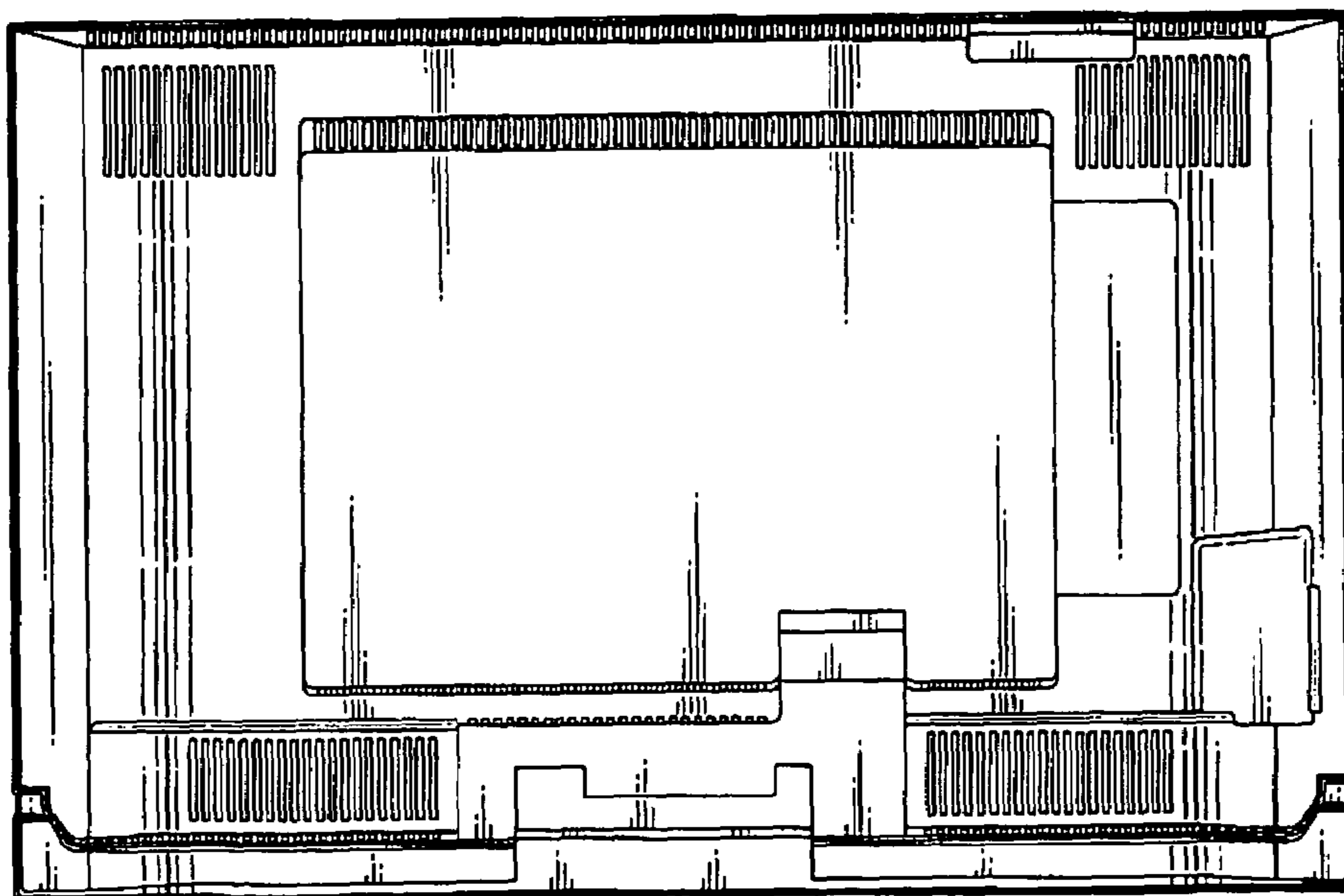

FIG.4

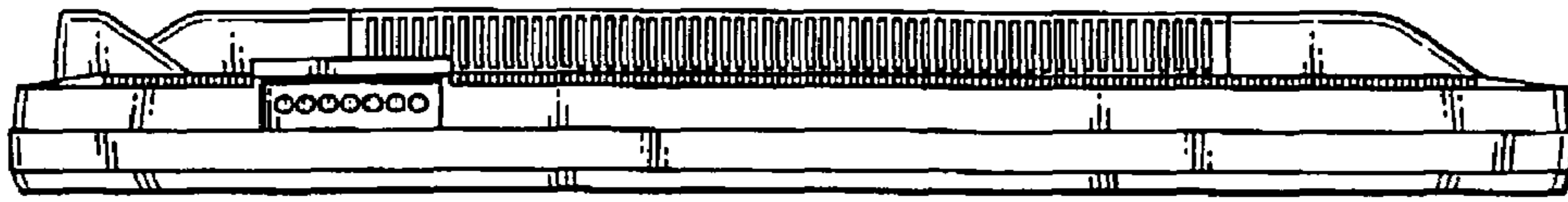

FIG.5

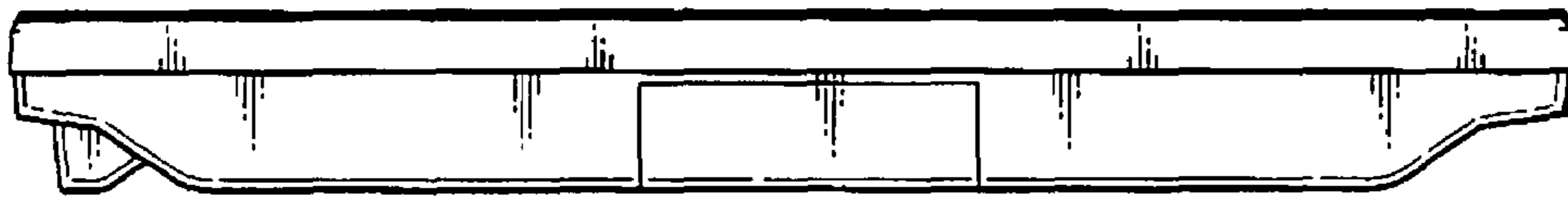

FIG.6



FIG.7

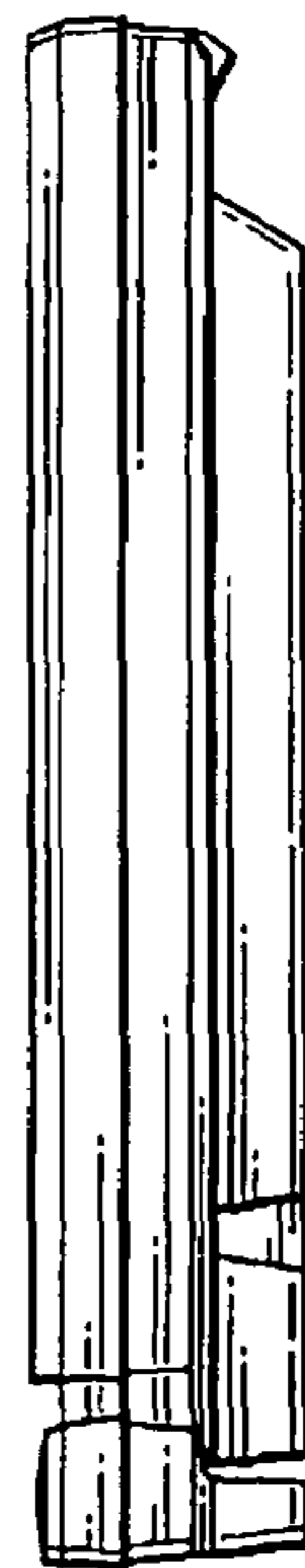

FIG.8

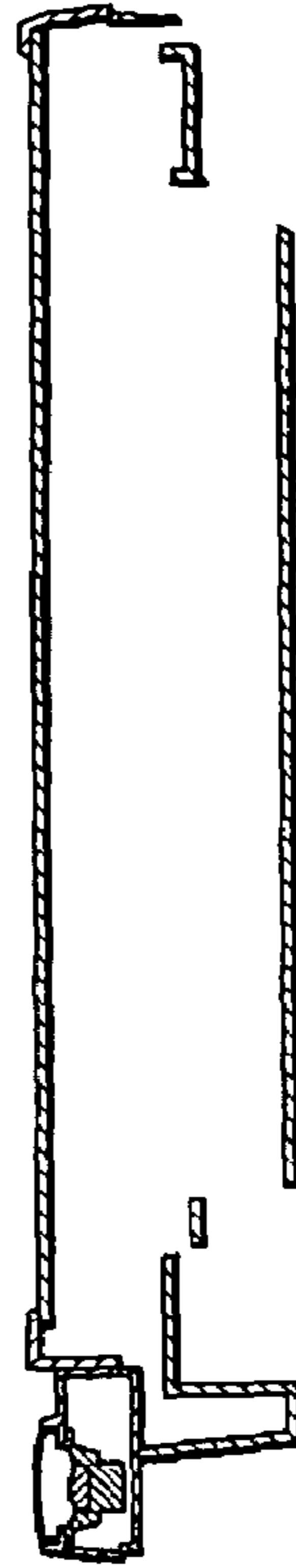

FIG.9

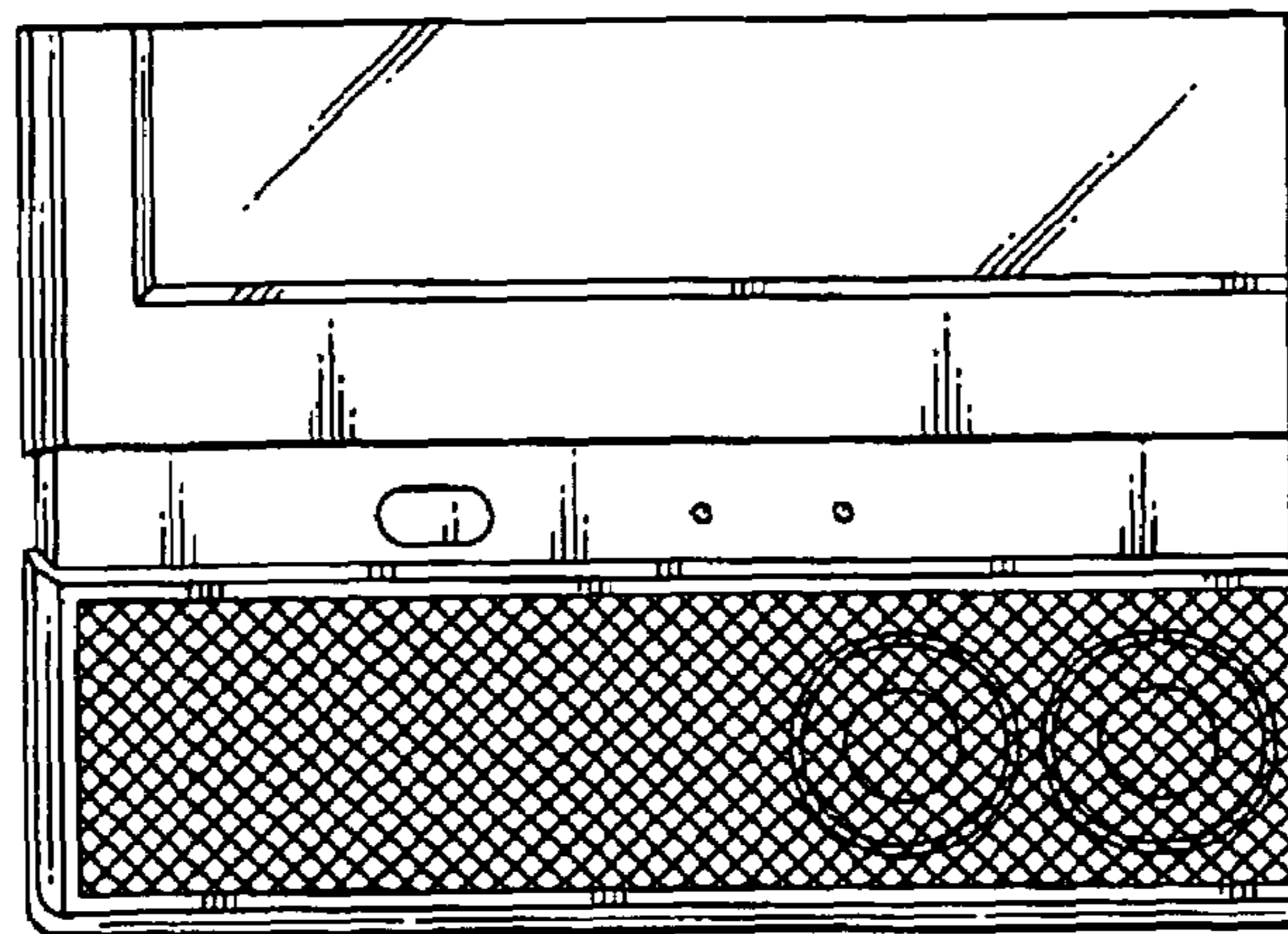

FIG. 10

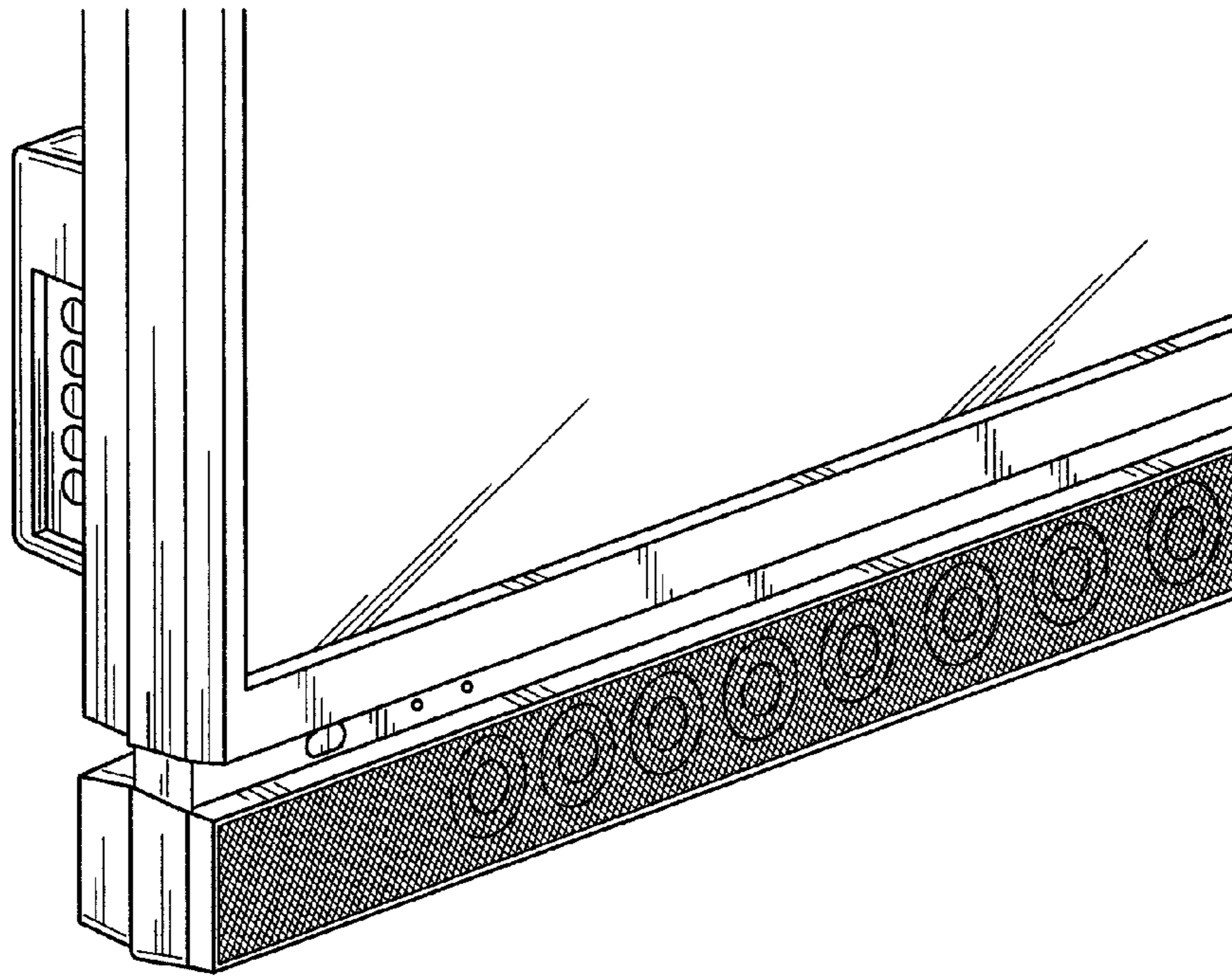

FIG. 11

